

HORIZON  
H O B B Y

RF9  
REALFLIGHT<sup>®</sup>



## RC Flight Simulator

Written and Edited by: Knife Edge Software™ and Horizon Hobby.

Software: © 2019 Knife Edge Software – Graphics, Packaging: © 2019 Horizon Hobby, LLC. 62521

**Horizon Hobby, LLC**

# **REALFLIGHT 9 RC FLIGHT SIMULATOR**

© Horizon Hobby, LLC.

2904 Research Road, Champaign, IL 61822

# Table of Contents

<b>Introduction</b>	<b>4</b>	Exit	123
RealFlight 9 Feature Highlights	5	<b>The Aircraft Menu</b>	<b>124</b>
How to read this manual	10	Aircraft Selection...	125
<b>Before You Begin</b>	<b>11</b>	Edit Current Aircraft	128
System Requirements	11	Quick Edit...	143
Video and Sound Cards	12	Select Color Scheme	144
Getting the Most out of RealFlight	13	Save Color Scheme As...	145
<b>Getting Started</b>	<b>14</b>	Randomize Color Schemes	147
Installing RealFlight 9 RC Flight Simulator	14	Remember Aircraft Position	148
Using Your Own RC Radio	23	Clear Aircraft Position	149
Exploring RealFlight 9	25	Reset Position	150
Keyboard Commands	40	Kill Engine	150
Where to Go From Here	42	Aircraft MRU	152
<b>Controlling RealFlight 9</b>	<b>43</b>	<b>The Environment Menu</b>	<b>153</b>
Start Flying!	46	Select Airport...	154
<b>The Simulation Menu</b>	<b>49</b>	Edit <i>Current Airport</i> ...	156
Select Scenario...	49	Utilizing the Editor	167
Manage Scenarios...	51	Create New Airport	173
Select Controller...	53	Sun-	174
Physics...	59	Thermals-	177
Graphics...	62	Wind-	177
Flight Failures	63	Reset to Default	182
Setup Failures	68	Airport MRU	183
Import	73	<b>Challenges Menu</b>	<b>184</b>
Export	75	Air Race	186
Manage User Files	77	Balloon Burst	187
Mute/Unmute Audio	80	FPV Drone Racing / FPV Racing League	188
Settings	81	Grapple	189
Capture Screenshot	121	Limbo	190
Show Title Bar	122	Quadcopter Trials	191

Ring Race	192	Text Chat	253
Scavenger Hunt	193	Enter MultiMode	254
Spot Landing	194	<b>Recordings Menu</b>	<b>257</b>
Locked Challenges	194	Start Recording	257
During Flight	195	Stop Recording	258
Pre-Flight Information	196	Open Recording...	258
Resume Existing Challenge...	196	Record Microphone Input	262
<b>Gadgets Menu</b>	<b>197</b>	Recordings MRU	263
NavGuides	198	<b>Training Menu</b>	<b>264</b>
Radio	200	Flight Training	265
Binocular	201	Heli Hover Trainer	271
Viewport	202	Heli Autorotation Trainer	278
Variometer	204	Heli Orientation Trainer	282
Multiplayer	205	Airplane Hover Trainer	283
Overhead	205	<b>View Menu</b>	<b>290</b>
Timer	206	Scenery	291
Heads-Up Display	207	Effects	292
Quick Load...	208	Camera Type	294
Close All	209	Camera Position	296
Edit NavGuides...	210	Look At	297
<b>Multiplayer Menu</b>	<b>215</b>	Zoom Type	298
Pilot Profile	218	Zoom In	299
Join	220	Zoom Out	300
Host	224	Zoom Reset	301
Disconnect...	227	Head Tracking	302
Host Options	228	<b>Help Menu</b>	<b>303</b>
Scoreboard	237	RealFlight Help	304
Server Details...	240	Radio Interface Help	305
Game Help...	241	Tactic TTX600 Help	306
Game Gadgets	242	Tactic TTX610 Quick Start	307
Select Target	246	Keyboard Commands	308
Simulation Sounds	247	Welcome Screen	310
Voice Chat	247		

Video Player	311
Reset to Defaults	313
Technical Support	314
Websites	315
License	316
About	317
<b>Virtual Reality</b>	<b>318</b>
<b>InterLink DX Controller</b>	<b>320</b>
InterLink DX Layout-	320
<b>Basics of Flying</b>	<b>326</b>
Airplane Basics	326
Helicopter Basics	329
Helicopter Flight	334
<b>RealFlight 9 Launcher*</b>	<b>336</b>
Run RealFlight	337
<b>If You Experience Difficulties</b>	<b>345</b>
How to Get Help and Information	345
Before You Do Anything Else	346
If You Need Additional Assistance	347
Examples of Common Problems and Solutions	348
<b>Transmitter Modes</b>	<b>350</b>
<b>Glossary</b>	<b>352</b>
<b>Index</b>	<b>377</b>
<b>License</b>	<b>383</b>
<b>Credits</b>	<b>387</b>

# Introduction

## *WELCOME TO THE REALFLIGHT 9 RC FLIGHT SIMULATOR*

**R**ealFlight 9 RC Flight Simulator is without question, the most advanced RC aircraft simulation available. It is so technologically advanced and so realistic, you'll find it hard to believe that it's only a simulation. The culmination of over twenty years of development and design, RealFlight 9 offers advancements that will serve to fine-tune the flying skills of even the most seasoned RC veteran. If you're an entry-level RC-er, RealFlight 9 is the ideal way to learn to fly, practice maneuvers, feel the effects of design modifications, or just have an incredible amount of fun. Thanks to the incorporation of groundbreaking Spektrum AS3X<sup>®</sup> and SAFE<sup>®</sup> stabilization technology, found in many of the additional Horizon Hobby aircraft, a better flying experience is available for a wider range of RC pilots.

RealFlight 9 includes over 160 models that look and fly like the real thing, plus a multitude of flying sites (each with their own unique "feel" and distinctive characteristics). In addition, RealFlight 9 offers its users the most powerful, flexible aircraft and flying site editors ever unveiled to the modeling community; allowing modelers to experiment with a virtually unlimited number of parameters. RealFlight 9 enables you to change the look and feel of a flying site with nothing more than a few keystrokes, a click of the mouse and a little imagination. The integrated AccuModel™ aircraft editor makes modifying aircraft just as easy.

RealFlight 9 also offers a wide array of tools to help you understand how to use the program and how to improve your RC piloting skills. This extensive manual explains every feature and option; as well as how to use them. We offer a number of training aids and assistance including (but not limited to): our Heli Hover Trainer, Airplane Hover Trainer, Heli Autorotation Trainer and Heli Orientation Trainer. Horizon has also included updated flight training lessons to assist new airplane pilots in the enjoyment of the hobby! These helpful training aids provide on-the-fly learning opportunities, and we encourage you to take full advantage of them. No other RC simulator goes further to enrich your RC experience.

The following section briefly outlines some of the exciting features in RealFlight 9. Subsequent chapters will describe all RealFlight features in complete detail. We strongly

suggest that you peruse this manual in its entirety, as it explains every feature and option, as well as how to use them.

Finally, we'd like to express our gratitude to you for purchasing RealFlight. We think you will be enormously pleased with RealFlight 9. Have fun flying!

Please note that while this manual has been written from the perspective of the RealFlight 9 iteration of the software. If, however, you are using a previous version of the simulation, most of the features and functions are still applicable as are the steps/procedures to access accordingly.

## RealFlight 9 Feature Highlights

This section briefly outlines some of the features included in the RealFlight 9 RC Flight Simulator with the Spektrum® InterLink DX Controller.

### USB Spektrum InterLink DX Controller-

New to the RealFlight 9 software is the recently developed Spektrum InterLink DX Controller. The multi-patented InterLink DX controller has been optimized for use within the simulation and incorporates a significant number of enhancements and improvements over previous RealFlight systems and control methodologies.

The InterLink DX Controller is a revolutionary device that offers you the following:

- A high-quality USB controller for RealFlight 9; backwards compatible to RealFlight 8 software releases, should you choose to do so.
- A built-in interface for (optionally) using your own RC transmitter to control RealFlight.
- QuickSelect™ Buttons—take control of RealFlight's menus and options from the InterLink DX without touching the keyboard or mouse.
- The InterLink DX Controller is fully *hot swappable*—you can connect and disconnect the InterLink DX or your own transmitter without rebooting your computer (or even shutting down RealFlight).
- High-speed response to control inputs.
- Digitally precise inputs with digital trims for unmatched control precision.
- A keyboard-free push button reset of the simulation.
- Instantly rewind your current flight and start over from any point.
- The ability to hand launch aircraft.

## Horizon Hobby AS3X and SAFE Technology-

New to the RealFlight 8 Horizon Hobby Edition, RealFlight 9 continues to expand the selections and offerings that include exclusive groundbreaking technology from Spektrum. Incorporating SAFE Select and AS3X in a multitude of models within this iteration ensures not only success for entry-level modelers but also a better flying experience for a wider range of pilots regardless of skill sets.

AS3X enhances the flight performance of models stabilizing the aircraft in whatever attitude the pilot commands. Countering external forces such as wind, torque, tip-stall, etc. our AS3X technology uses a combination of flight sensors to ensure a pleasant flying experience.

SAFE Select is a complementary technology to the AS3X flight performance. With the flip of a switch, SAFE Select is active and limits the pitch and roll angles keeping the aircraft airborne and eliminating any fears.

## USB interface-

RealFlight 9 is also backwards compatible for users that have purchased previously offered RealFlight interface options. These items offered a simple method to use your own transmitter without a lot of fuss. Like the InterLink DX, these interfaces are plug-and-play for quick installation. If you own one, the wired interface allows you to connect most popular radios through the trainer ports that are PPM compatible. Alternatively, there was also a wireless interface available. This wireless interface works perfectly with SLT transmitters, like Tactic radios, or any radio utilizing the AnyLink adapter.

Spektrum users will appreciate the currently offered Spektrum WS2000 wireless simulator dongle (Horizon SKU SPMWS2000), allowing modelers to control the action with a Spektrum DSM2 or DSMX-compatible transmitter.

## Menu-Driven Interface-

RealFlight 9 utilizes a drop-down menu-driven interface system. Created for ease of use and maximum flexibility, the menu system provides an interface familiar to even a casual computer user.

## Additional Features-

- **Virtual Reality** – RealFlight 9 is compatible with the Oculus Rift and HTC Vive, popular VR Goggles.
- **RealPhysics™ 3D**- One of the most ambitious models of flight in the world, RealPhysics 3D is unmatched in its ability to re-create the lifelike characteristics of model flying. RealFlight 9's physics engine has been tried and approved by Horizon Hobby's own world-class competition pilots like Ali Machinchy, David Payne, James Haley, Dustin Buescher as well as many others. Furthermore, aircraft in RealFlight 9



behave with real-world predictability because they are carefully modeled using advanced methods and extensive real-world data. If it happens at the field or in the air, it's re-created with exacting detail in RealFlight 9!

- **Challenges-** These game-like events provide a fun way to test and develop your skills. Each has multiple levels. Difficulties increase as you move from one level to the next. Successfully earning a medal in each challenge unlocks new content.
- **Ghost Runs-** Compete against your best time in the Challenges with ghosted images of your flights, pushing you to complete each level faster.
- **Float Fly-** RealFlight 9 offers a number of flying sites with water along with a variety of float fly aircraft. In fact, RealFlight 9 Horizon Hobby Edition even includes E-Flite's 1.5m Timber on Floats- one of the most popular RC airplanes available. Practice your takeoffs or landings on water and admire the view at the same time.
- **Instant Rewind-** Test your pattern flying over and over again with the Rewind feature. Hold the Reset button and watch your flight rewind. Let go of the button at the point you wish to re-start your flight. Use the data lever on the controller to seek forward or backwards through your flight.
- **InterLink DX QuickSelect™-** With RealFlight 9's InterLink DX controller, you're able to make quick changes such as, selecting a different aircraft or airport without touching the keyboard or mouse. New to RealFlight 9 is the scroll selection wheel which makes it even easier- and faster- to make your in-sim selections.
- **Quick Load-** Know the name of the aircraft or flying site you wish to use? Open the Quick Load gadget to quickly search and load the aircraft.
- **Quick Edit-** If you ever wish to make minor refinements to the aircraft, but don't wish to dive into the complexity of the full aircraft editor, the Quick Edit is the solution for you!
- **Training Videos-** Access the built in video player to training and feature videos. For RealFlight 9 we've even expanded the Flight Training tutorials to ensure success for new modelers.
- **Real Rendering™-** Taking advantage of cutting edge 3D graphics technology, RealFlight not only flies realistically; it also looks true to life.
- **Variable Pitch Prop-** Take 3D flight to 4D with the variable pitch prop. Select the FlatOut™ Extra 300S with V-Pitch and try amazing maneuvers you didn't think were possible with an airplane—like flying backwards.
- **Grappling Hook-** Select the Skycrane heli to hook, grapple and drop objects.

- **Hovering Training Aids-** Learn to torque roll or hover a heli with RealFlight’s Heli and Airplane Hover Trainer. For more excitement, try the Heli Orientation Trainer. Both are great training aids for anyone new to radio control.
- **Overhead View-** This on-screen gadget helps you find and line up to the runway for easier landings. Or use it to help find your friends during multiplayer sessions.
- **Sky Grid and Trails-** Practice your precision maneuvers with these graphical aids. Sky Grid will display a pattern in the sky for reference. Enable Trails and you will see where your aircraft has flown; allowing you to perfect your maneuvers.
- **Night Flying-** Just because the sun is down, doesn’t mean that you can’t fly. The same is true with RealFlight night flying. Pick a nighttime airport and watch as your aircraft lights up the sky.
- **PhotoFields™-** RealFlight 9 also includes ultra-realistic PhotoField airports. Using incredible high resolution digital images, RealFlight PhotoField airports are as real as it gets. In fact, RealFlight 9 even includes Eli Field, home to the Monticello Model Masters, Horizon Hobby’s annual RC Fest event and where many of the Horizon Hobby’s models are test flown and approved. Further, the Import feature allows you to use your own panoramic photos to create new flying sites.
- **“Full Coverage” collision detection-** Instead of using sensors at only a few points along the aircraft, “Full Coverage” blankets the entire aircraft with detection points ensuring that every part of an aircraft will not only register a strike but, will react authentically. Contact can result in damage ranging from minor handling problems to spectacular crashes complete with realistic sound effects.
- **TruFlo Wind Dynamics™-** RealFlight 9 introduces modelers to RC’s most realistic wind model. All the components of TruFlo Wind Dynamics work together to create the single most accurate wind field in any simulation. Wind impacts every facet of your flight, just as it would at the local field.
- **AccuModel™ Aircraft Editor-** RealFlight 9’s aircraft editor is the most powerful and most flexible editor ever introduced in an RC simulator. AccuModel allows you to change virtually every aspect of your model with ease. It places over 1,500 airfoils at your disposal, a multitude of propellers, and much, much more! AccuModel brings up a wire-frame model for easy reference and highlights the editing area. Make a change and it’s immediately reflected on-screen, ready for review and revision.
- **Flying Sites with over 5,000 square miles to explore-** RealFlight’s TrueLife Terrain™ goes beyond the limitations of traditional simulator flight. Created and mapped from satellite imagery, RealFlight 9’s landscape looks as “right” and richly varied as the view from your front door. Digital elevation data brings it all into accurate perspective.

- **A living, breathing environment-** Everything in RealFlight 9's 3D world is as realistic as possible; complete with depth and details that transcend the traditional "billboard" look of other simulators. You'll see leaves and branches that dance in a passing breeze and clouds that roll by with the prevailing winds.
- **FlexiField™ flying site editor-** The FlexiField™ editor takes you beyond 2D scenes into a 3D environment rich in new objects and editing options. Customize an existing field with new foliage, different objects, or both. Create a new field with nothing more than a mouse, imagination and a few simple keystrokes.
- **InterLink DX Controller-** Modeled after Spektrum transmitters, RealFlight 9's Spektrum InterLink DX controller functions as a controller, or an interface. This new unit is capable of resetting and rewinding the aircraft, or hand-launching a sailplane. Additionally, the InterLink DX is the key to navigating the QuickSelect menus – select alternative aircraft, flying sites and more, all from the controller.
- **VirtualRevolution™ sound technology-** Doppler-correct stereo sounds heighten the realistic effect with true sound recordings of 2-stroke, 4-stroke, turbine, electric, ducted fan and gasoline engines. As the aircraft crosses the field, the engine sound follows, just like its RC counterpart.
- **RotoSonic™ technology-** Recreating distinctive engine/blade sounds with startling accuracy. The sounds are so lifelike, you'll swear you are at the field!
- **AFR (Advanced Flight Recorder)-** This feature allows the pilot to not only view prerecorded maneuvers, but also to record maneuvers of his/her own as well. RealFlight 9 even allows you to record your own audio for personalized flight instruction. This feature also allows you to pause, speed up, slow down, and loop the performance. The pilot has the option to activate the digitized transmitter display, so that he/she can view the radio input while flying.
- **NavGuides™-** Using the NavGuides, you can display a variety of heads-up on-screen information. Options range from altitude and airspeed to aircraft heading and engine RPM. This feature improves your ability to "see" what is going on in your virtual world.
- **Viewport-** You can open up a picture-in-picture display and treat it as an independent "window on the world". You can individually adjust each of the viewport's vantage points, zoom level, and direction of view.
- **Multiplayer-** You can fly with many other RealFlight 9 owners. Participate in online competitions, or just enjoy the thrill of flying around with one another. This feature can also be used to learn new maneuvers from pilots across the street or around the world.

- **Combat Events-** Compete in Streamer Cut, Paintball, Rocket and Machine Gun combat. Or combine racing and combat in an exciting match of DeadRinger™. Plug in a headset and microphone to your computer and chat live during these contests.
- **Animated control surfaces and retracts-** Control surfaces, retracts, propellers, and rotor blades move for added realism.
- **Aircraft exhaust/smoke-** You can control the color, density, “hang time”, and other parameters related to airplane and helicopter smoke and exhaust.
- **Streamers-** Add streamers to any aircraft, to any location, in any color. Watch as they corkscrew behind the airplane during a roll, or react accordingly to the wind and the propwash.
- **Flight Failures-** RealFlight can simulate many common flight failures (radio interference, stuck servos, engine failures, etc.). Use this feature to prepare for emergencies at the field.
- **Fully editable aircraft paint/decal schemes-** Create customized trim schemes for your aircraft. (To design your own paint scheme, you must use a third-party program that edits TGA files.)
- **Launcher-** RealFlight 9’s Launcher allows for easy one-click access to program upgrades, the RealFlight 9 manual, and technical support. [DVD and Tower Hobbies Digital versions only.]
- **Extensive Help materials-** RealFlight 9 features extensive online tool tips and diagrams, a detailed manual, and technical support to enhance your enjoyment of the program.

## How to read this manual

RealFlight 9 is a menu-driven program, which allows you to make quick changes without having to reload the simulator each time. This manual will break out each main menu to its own chapter. This allows you to quickly find information on features and functions by the related menus.

Along with this manual, a large RealFlight community is available online to help and discuss any topics with each RealFlight fan. This online support, in the form of a forum, can be found at:

<http://www.knifeedge.com/forums/>

# Before You Begin

*TO GET THE MOST OUT OF REALFLIGHT 9, IT HELPS TO FIRST UNDERSTAND HOW TO GET THE MOST OUT OF YOUR COMPUTER.*

**R**ealFlight 9 is designed to work on a large variety of computer hardware. Similar to a car, if you want to go faster, you need a bigger engine. The same holds true with RealFlight. You'll be able to enjoy the simulator on most modern computers, but having the most up to date hardware for your computer will greatly increase your enjoyment.

## System Requirements

You will find the suggested system requirements for the RealFlight 9 RC Flight Simulator listed below. The minimum recommended system requirements are the bare minimum PC configuration for installing RealFlight 9. Meeting the minimum requirements will allow you to enjoy RealFlight 9. However, in order to take complete advantage of the many features and functions offered by RealFlight 9, you should have a computer that meets or exceeds the specifications as specified in the optimum system requirements.

### Minimum Recommended System-

- Some graphical features may be disabled
- Aerodynamic Calculations will still be high-quality

Windows\* 7, Windows\* 8 or Windows\* 10

\*Administrator Access Required

Intel Pentium 1.0GHz or equivalent

512 MB RAM

10 GB Hard Drive Space

DVD Drive [DVD version only]

Broadband Connection

3D Accelerated Video with:

- 32 MB Dedicated Video Memory
  - Full DirectX 9 compliant (Shader Model 2.0 or better)
- Available USB 2.0 port

### **Optimal System-**

- For best graphical performance

Dual Core 2.4GHz CPU

2 GB RAM

3D Accelerated Video with:

- 512 MB dedicated video memory

### **Multiplayer Requirements-**

Broadband connection

Computer microphone for voice chat

### **Virtual Reality Headset-**

Please refer to the system requirements necessary to support your device.

## **Video and Sound Cards**

In order to achieve optimum performance and the best flying experience in RealFlight, there are two important components of your computer that deserve special attention: the video and sound cards.

RealFlight 9 has undergone countless hours of compatibility testing and evaluation. As such, this software will adequately function with a variety of video cards—ranging from yesterday’s favorites to tomorrow’s hits.

While RealFlight works well on a wide variety of hardware configurations, it offers many features and functions that are designed to take particular advantage of the latest video technology. If you have an older computer, or a newer computer with a lower-end video card, you may want to consider purchasing a new video card to take advantage of these features and functions. This moderately priced upgrade can vastly enhance your enjoyment of RealFlight. Aside from increasing your satisfaction with RealFlight 9, a new video card will also work with many other games or simulators, improving their performance as well.

While not as important as the video card, upgrading your sound card may also improve your satisfaction with RealFlight. This is especially true if your computer uses an on-board sound card (a sound card affixed to the motherboard).

## Getting the Most out of RealFlight

We think you'll agree that RealFlight offers the finest set of instructions and practice tools of any RC simulator suited for both beginners and experienced pilots. Horizon Hobby and Knife Edge Software are committed to the continual improvement of our products. When using the software, you should keep two things in mind:

First, similar to other pursuits, what you get out of RealFlight depends upon what you put into it. Mastering radio control requires a great deal of patience and practice. If you crash an aircraft in the simulation, take it very seriously. Crashing an actual RC aircraft can cost you a lot of time and money. Try to identify what you did incorrectly, and use the experience to avoid making the same mistake again.

Secondly, while the simulator is quite realistic and will assist you in learning many of the skills necessary to become a proficient pilot, there is no substitute for actual flying time at the field. A simulation can be a wonderful practice tool. However, no simulator, no matter how realistic, can completely replace a qualified, experienced, human flight instructor. If you are new to RC, you should never attempt to fly a real aircraft without the supervision of a qualified instructor; no matter how accomplished you are on the simulator.

# Getting Started

## *A BRIEF OVERVIEW AND ASSISTANCE TO START YOU ON YOUR RC ADVENTURE.*

**T**his chapter covers the installation procedure for RealFlight 9, it describes the basics of running the program, and introduces you to some of RealFlight's frequently used features.

The first section, *Installing RealFlight 9*, offers a step-by-step approach to the installation procedure for both the program software and the controller.

The second, *Using your own RC Radio*, offers the instructions you need if you intend to use your own RC transmitter to control RealFlight 9. If you only wish to fly with the InterLink DX controller, you may choose to skip this section.

Finally, the third section, *Exploring RealFlight 9*, offers a brief tour of the RealFlight 9 program. You'll learn how to perform some basic functions, such as selecting the aircraft you wish to fly, performing simple edits to the flying field, enabling helpful gadgets, and manipulating viewports.

This chapter only touches briefly on some of RealFlight 9's features. We strongly suggest that you also read the subsequent chapters, which describe the various features in comprehensive detail.

## Installing RealFlight 9 RC Flight Simulator

Regardless of whether you plan to use the InterLink controller by itself, or your own Spektrum radio through the built-in transmitter interface, follow the instructions on Program Installation in this section.

### Program Installation-

RealFlight 9 features a very simple, installation process. After the disc installation has been completed there are further steps that must be followed prior to running the program for



the first time. This section will explain how to install the RealFlight 9 software and hardware. Upon completion of this section, you should be able to fly the aircraft on your PC.

The InterLink DX controller's built-in transmitter interface also allows you to use your own Spektrum, or other, RC transmitter to control RealFlight 9 should you opt to do so. To activate the interface adapter, you will first need to follow the instructions in the section below. This section explains how to use the transmitter interface option in the InterLink DX controller. Further, it might be necessary to purchase the optional transmitter interface cords- RFL1015- in order to utilize a Spektrum, or other such RC transmitter via the interface.

### **Update Drivers-**

As mentioned above, before you begin installation, we strongly suggest that you update the drivers for both the sound and video cards on your PC. A driver is a software program that your computer uses to control hardware devices. Each card has its own respective driver. Most problems with installing and using RealFlight, as well as many other programs that use Microsoft DirectX, arise from using outdated video and/or sound card drivers.

If you are not sure how to update your drivers, it is suggested that you visit the support site associated with the manufacturer of the video and sound cards on your PC for information on how to do so.

### **Connect the InterLink DX Controller or interface-**

The InterLink DX controller, and the Spektrum Wireless Simulator Dongle use the USB (Universal Serial Bus) port, so there is little to do in the way of setup. The Spektrum Wireless Simulator Dongle will be covered in a separate section of this manual. If this is the methodology that you have selected for use in controlling the simulation, please refer to this section accordingly.



**It is imperative that you plug in your controller or interface into the computer first, before installing the RealFlight software!**

1. With the software installation procedure complete, firmly plug into an available USB port on the PC. You do not have to shut the PC down to plug the controller in.

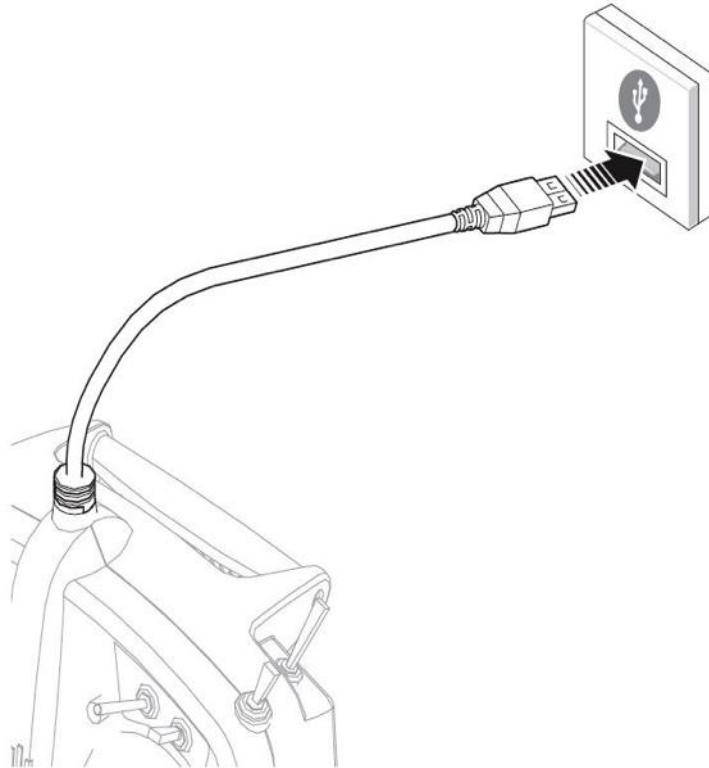

2. Shortly after plugging in, a dialog box should appear on the screen indicating that Windows has located a new device and will then automatically install the necessary drivers.

Please note: It is possible that Windows will need to install the appropriate files for the InterLink DX or interface to function properly.

### Changing the throttle stick ratchet-

The InterLink DX incorporates a smooth throttle operation by default. This is the preferred methodology for many pilots. If, however, you wish to refine the controller to incorporate a ratcheted throttle, the Spektrum InterLink DX makes it easy to do so.

The InterLink DX has all the physical transmitter adjustments located around the gimbal face of each gimbal. This arrangement allows for quick and easy adjustments without taking the back cover off or removing any plugs to access adjustment screws.

Additional information pertaining to the Spektrum InterLink DX may be found in Appendix A of this manual.

Available adjustments:

- Change the Throttle Ratchet
- Change the Throttle Tension
- Adjust Stick Tension

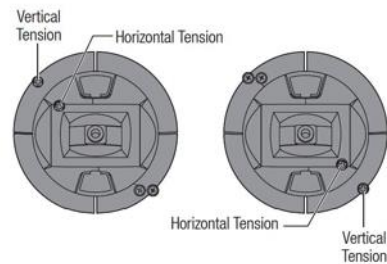

### Ratcheted Throttle- Smooth Throttle Adjustment- RATCHET:

- Locate the throttle strap adjustment screws on both gimbals. The ratchet screw engages a serrated section of the gimbal, while the tension screw engages a strap for smooth tension on the gimbal.
- To engage the throttle tension ratchet, turn the ratchet screw clockwise until the ratchet engages.
- To disengage the throttle ratchet, turn the screw counter-clockwise until the gimbal moves freely.

### SMOOTH TENSION:

- To engage the throttle tension, turn the respective screw clockwise until the tension engages.
- To disengage the throttle tension, turn the screw counter-clockwise until the gimbal moves freely.

### Adjust Stick Tension-

Using a Phillips screwdriver, turn the screws clockwise a small amount to tighten the stick tension and counter-clockwise to loosen the stick tension.

Note: We strongly suggest testing the stick tension while turning these screws to ensure that stick tension is not too loose or too tight. Tightening a screw too much can damage the spring. Loosening the screw too much could cause a spring to fall off, possibly resulting in a short-circuit in the transmitter.

### Control Stick Length Adjustment-

- Using a 2mm Allen wrench, turn the screw in the stick counter-clockwise to loosen it.
- Make the stick length shorter by turning the stick clockwise, or longer by turning it counter-clockwise.
- After refining the stick to the desired length, tighten the screw in the stick clockwise.

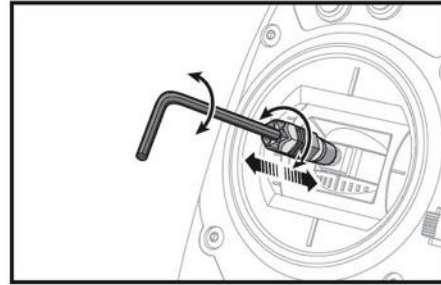

### Mode Change Slider-

The Spektrum InterLink DX Controller has a unique, patent-pending, slider located on the rear of the controller that allows for simple mode changes. This slider may also be used to change to the 'quadcopter' mode whereby the mode snaps both sticks to their centered position.

### Safety Plug

The safety plug is installed in the transmitter to ensure the mode switch cannot be accidentally moved when in the normal throttle mode (non-centered) positions.

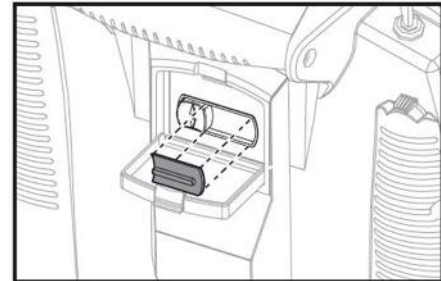

To remove the plug:

- Grasp the plug by the raised rib and pull straight out. Note: A small flat-bladed screw driver may be used to **gently** pry the plug out if necessary.
- Once the mode has been changed, reinstall the safety plug accordingly.
- Simply open the protective slider door and move the slider to the desired position. All changes happen automatically inside the transmitter.

### Changing the Stick Configuration

- With the safety plug removed, ensure that both gimbal sticks are centered.
- Gently push the slider mechanism to the desired mode configuration as shown in the images to the right.
- Once the mode has been changed, reinstall the safety plug.
- Note: it will be necessary to edit the controller's operational mode, mapping the InterLink DX's profile within the simulation. Information on how to do so is found in the Select Controller section on page 57

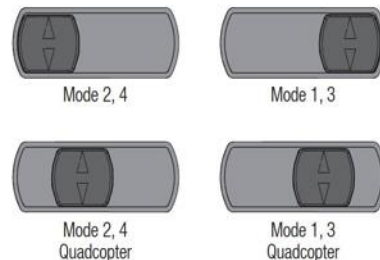

### Installing the Software\*-

[\*DVD and Digital versions only; NOT Steam iteration]

After you have completed installation of the new video and sound card drivers, you are now ready to install the RealFlight 9 RC Flight Simulator program.

**If you do not own a DVD drive, the software is available as a digital download: <https://realflight.com/dlrf9>.**

1. Before installing the program, make sure to close any applications that you are running. This includes virus scanning software and other similar background applications.
2. [DVD version only] Insert the first **RealFlight disc**, labeled Disc 1, into the appropriate DVD drive.
3. [DVD version only] If Auto-Play is active, setup will begin automatically when the DVD drive is closed. Simply click the **Install** button when prompted. If Auto-Play is not active, click Start on the task bar. Next, click **Run**. In the dialog box that appears, type '**d:\setup**' (assuming that 'd' is your DVD drive) and click **OK**.

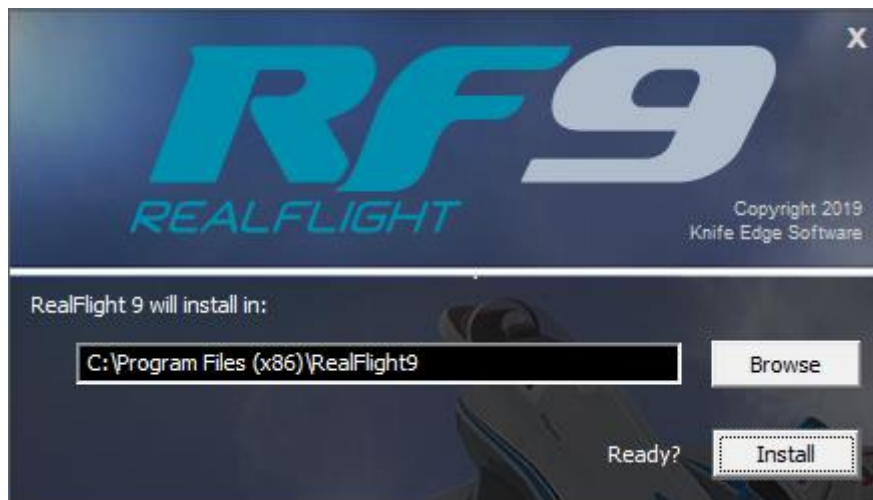

Follow the on-screen instructions to complete the setup procedure. Please make sure to insert the RealFlight Disc 2, when prompted to do so. Upon completion of the installation, click **OK**.



## Starting RealFlight 9\*-

[\*DVD and Digital versions only; NOT Steam iteration]

1. Double-click the **RealFlight 9 Launcher** located on your desktop.
2. Type the RealFlight 9 **software serial number** in the appropriate location. This is the serial number that includes the 'R9'. Please be sure to enter the serial number exactly as it appears, and in the proper on-screen fields. Failure to enter the serial number correctly will not allow you to proceed to the next step. Once the serial numbers have been entered properly, you will see that the OK button will now become active and allow you to continue.



3. Click **OK**. RealFlight 9 will attempt to activate your software. The activation process must proceed in order to run RealFlight 9. If the computer is not currently connected to the internet, this activation process will fail to connect to the activation server and the following window will appear.

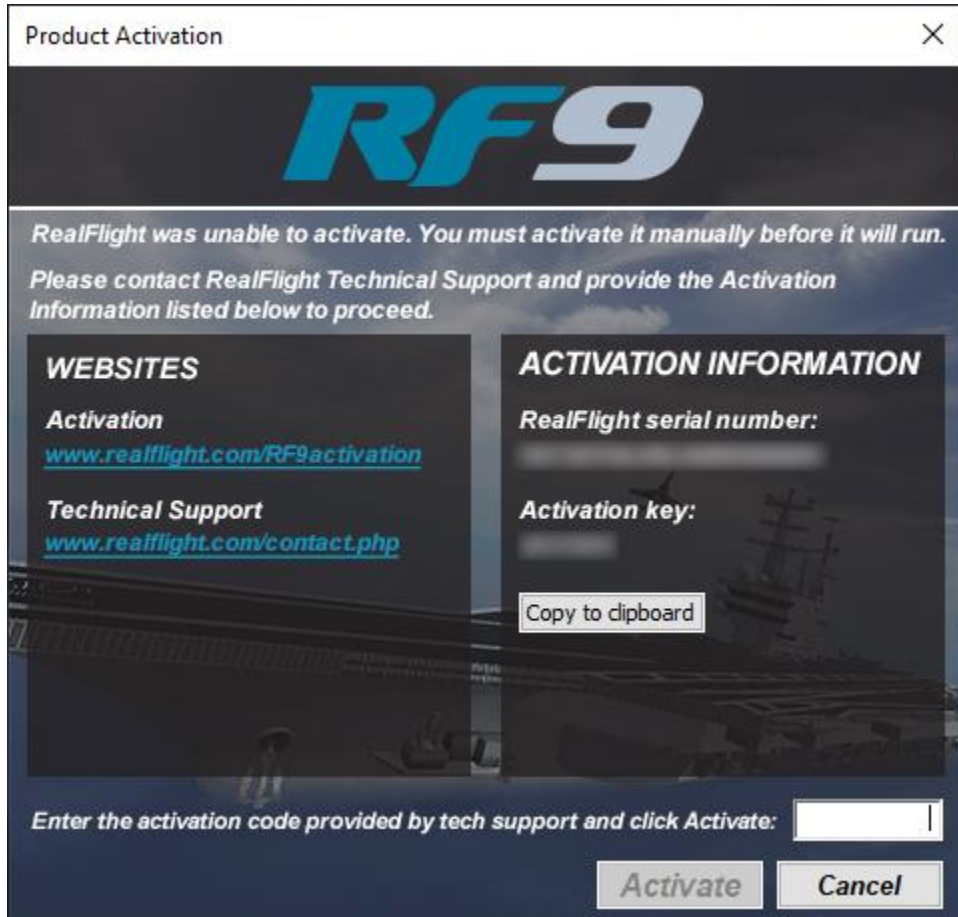

If you do not have internet access on the computer which RealFlight 9 is installed, follow the on-screen prompts. Write down the serial number and activation code that appear and log on to [www.realflight.com/RF9activation](http://www.realflight.com/RF9activation) on a different computer to activate RealFlight 9. Alternatively, you may contact Software Support via email or phone.

4. Once activated, the RealFlight 9 Launcher will appear. If the software has been updated since the creation of this DVD, most likely as Horizon Hobby is always working diligently to enhance the enjoyment of this program, the update information will appear below the Run



RealFlight button. Click the **Update to 9.XX.XXX** to access the latest build. After the updated files have been received, click **Run RealFlight**. RealFlight 9 will start with the default aircraft and default flying site.

### Starting RealFlight 9\*- [\*Steam version only]

1. Run the Steam client, select RealFlight 9 in your library, and click the Play button. Select the launch option that best fits your needs. (If you elected to create desktop and/or Start menu shortcuts when installing, those will use the most recent launch option selected in the client.)
2. RealFlight 9 will attempt to activate your software. The activation process must proceed in order to run RealFlight 9. If the computer is not currently connected to the internet, this activation process will fail to connect to the activation server and the following window will appear.

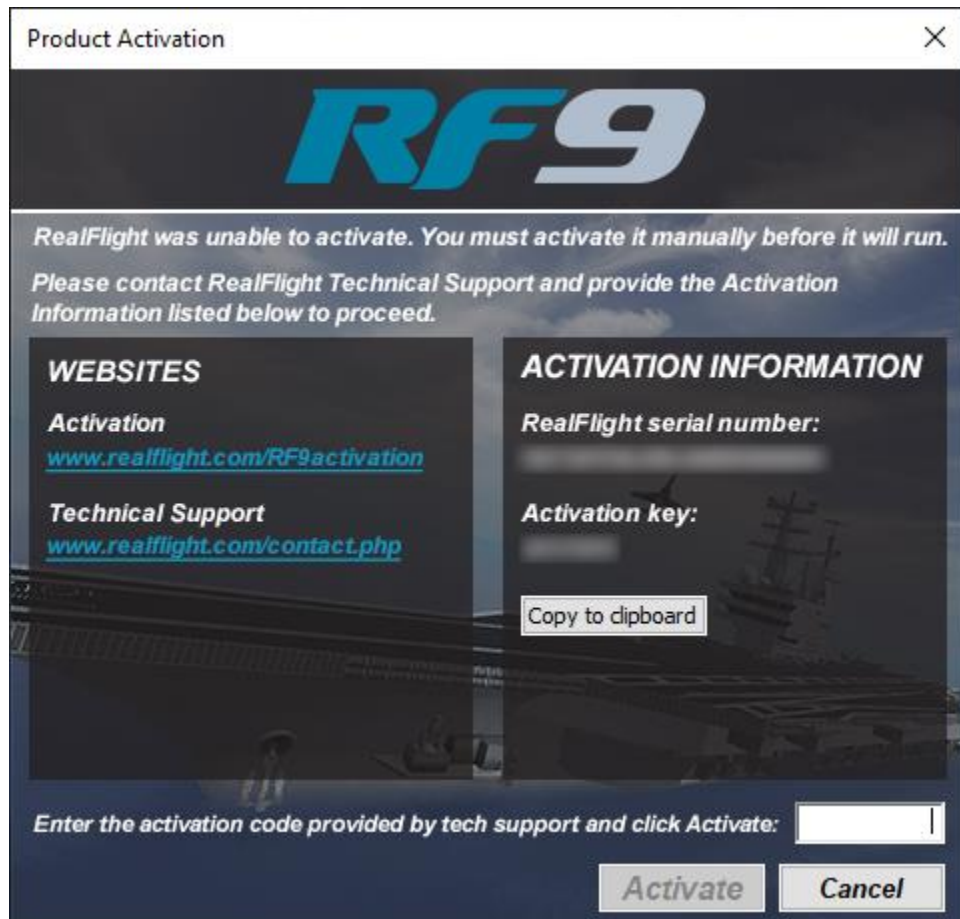

If you do not have internet access on the computer which RealFlight 9 is



installed, follow the on-screen prompts. Write down the serial number and activation code that appear and log on to [www.realflight.com/RF9activation](http://www.realflight.com/RF9activation) on a different computer to activate RealFlight 9. Alternatively, you may contact Software Support via email or phone.

3. After activating successfully, RealFlight 9 will start with the default aircraft and default flying site.

## Using Your Own RC Radio

The RealFlight interface requires you to fly in the simulator using your own RC transmitter.

Alternatively, if you purchased the RealFlight 9 InterLink DX controller, it offers several different modes of operation. By itself, it serves as a realistic 'stand alone' controller or joystick. Alternatively, it has a built-in interface that lets you use your own RC transmitter, such as a Spektrum transmitter, to control RealFlight 9.

Follow these instructions if you intend to use your own RC transmitter to control RealFlight 9. If you do not want to use your own transmitter, you may skip this section.

### Connecting Your Transmitter to the InterLink DX-

You can use your RC transmitter to control RealFlight 9 by connecting it to the InterLink DX controller, 'buddy box' style (see diagrams). If you do not already own them, we offer adapter cords to enable you to connect many popular brands (including Spektrum) to the RealFlight 9 simulation. These optional cords are offered as RFL1015 and may be found at your local retailer, or online hobby shop.

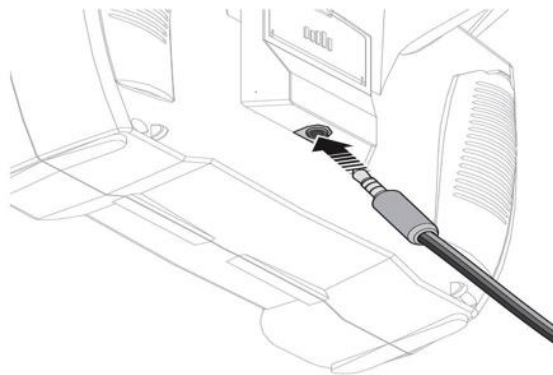

Locate the cable input port on the rear of the InterLink DX Controller. Plug one end of the interface connector cable into this port. Next, plug the other end of the adapter cable into

the buddy box port (a.k.a. trainer jack) of your transmitter. The procedure for doing so depends on your transmitter:

- If your transmitter's buddy box port directly accepts the 1/8" stereo plug, insert this end directly into the radio. This works for many Spektrum® radios.
- If your transmitter's buddy box port requires the micro (square) connector, use the square adapter cord included with the optional interface adapter cord package.

## Connecting your Transmitter to the RealFlight wired interface-

Some RealFlight users might have the previously available RealFlight wired interface offering. RealFlight 9 is backwards compatible and will function adequately with this interface if so desired. The information that follows will facilitate the use of this interface. Again, it may be necessary to purchase the optional transmitter interface adapter cords to do so.

The USB end of the interface should already be plugged into the computer. Plug the other end of the interface cable into the buddy box port (a.k.a. trainer jack) of your transmitter. The procedure for doing so depends on your transmitter:

- If your transmitter's buddy box port directly accepts the 1/8" stereo plug, insert this end directly into the radio. This works for many Spektrum® radios.
- If your transmitter's buddy box port requires the micro (square) connector, use the square adapter cord included with the interface adapter package.

After you have connected your transmitter, you will need to perform a brief setup procedure before utilizing it with the simulation.

1. If applicable, make sure that the transmitter is in FM or PPM mode rather than PCM mode. Refer to the manual for your transmitter if you are unsure how to do this. Note: with many of today's 2.4GHz spread spectrum radios this step is unnecessary and may be skipped accordingly.
2. If the transmitter did not power up when the interface cord was plugged into it, turn the power switch on at this time.
3. Next, click the **Simulation** menu and then highlight the **Select Controller...** menu item. Choose the correct **Profile** from the drop down option, or create a new one to match your radio. For more detail information about this dialog, see page 53.

## Binding your SLT Transmitter to the RealFlight wireless interface-

As noted above, we have previously offered a wireless transmitter interface compatible with equipment that offered the SLT protocol. This was created to allow the use of Tactic® branded transmitters in the simulation.

If you own this piece of equipment and will be using a Tactic-branded transmitter, the wireless interface should already be plugged into the computer. With your Tactic® transmitter turned on, following these steps to bind your radio to the RealFlight 9 RC Flight Simulator.

1. From the **Simulation** menu, click the **Select Controller...** menu item. The following window will appear:

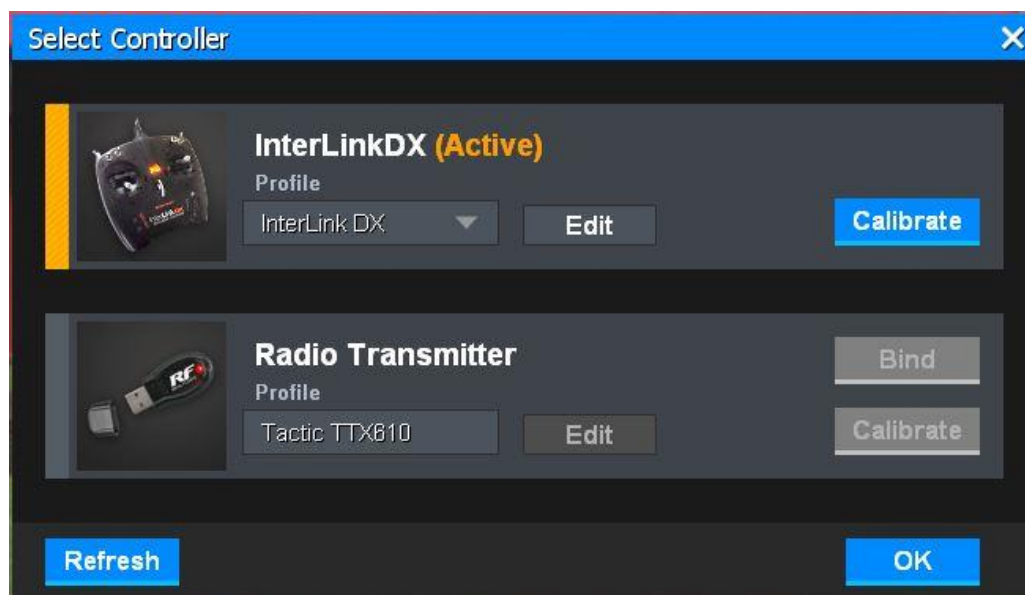

2. With your Tactic SLT radio turned on, click the **Bind** button.
3. When the red light on the wireless interface turns solid, your radio is bound to RealFlight. You should not need to go through this process again, unless you choose to use a different radio.

It is possible that you may still need to edit the radio profile to work with the channel mapping of your radio. Please see Select Controller... on page 53 for more information.

## Exploring RealFlight 9

Now that you have completed the installation of the RealFlight 9 program, it's time to begin exploring the program. The following sections will take you on a quick tour of RealFlight 9's

most popular features, such as selecting an aircraft, choosing alternate flying locations, customizing the flying sites, and using the training aids instruction. Along the way, we will show you where to go for help and how to obtain additional information.

Even if you are familiar with previous versions of the RealFlight software, you should read this section thoroughly. Some features described here are either new, or have been completely revised for RealFlight 9.

## Start the Program\*-

[\*DVD and Digital versions only; Not Steam iteration]

1. Close all open applications. This includes virus scanning software and other similar programs.
2. Double-click the **RealFlight 9 Launcher** located on your desktop.
3. To start the simulation, click the **Run RealFlight** button. As mentioned previously, if there is an update available, this update will appear beneath the Run RealFlight button. We strongly encourage you to update the software each time an update is available.

The program will start by displaying a Welcome Screen. The Welcome Screen allows you to select amongst a multitude of options which include, but are not limited to, choosing an aircraft, flying site or a scenario (a pre-selected combination of aircraft and flying site), receive a lesson, and/or earn challenge medals as desired. Additionally, at the bottom is a large button to allow you to jump directly into RealFlight and start flying immediately.

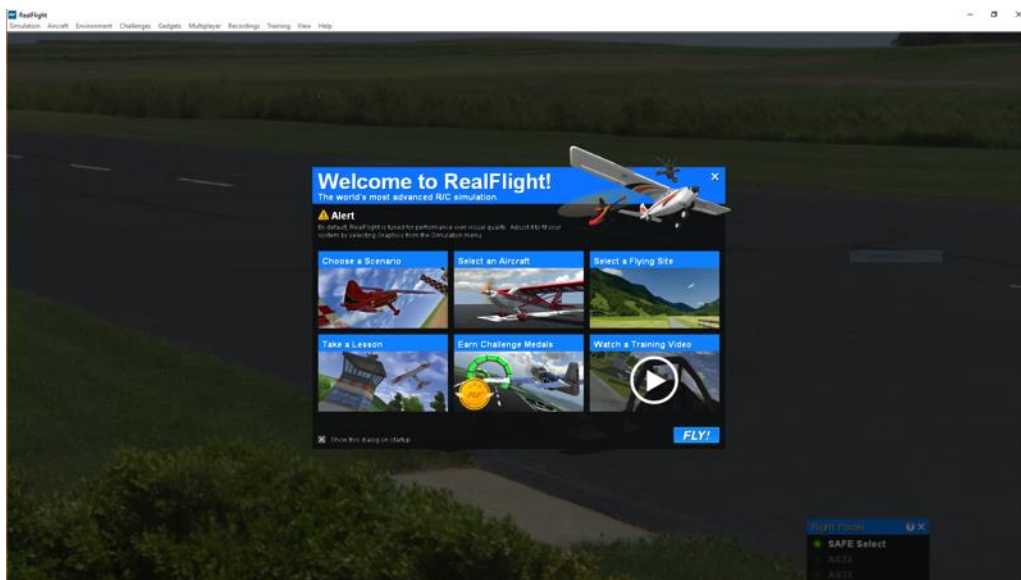

From the Welcome Screen, you can also access a number of helpful videos. The videos will walk you through some of the more popular features of RealFlight. For true beginners of RC, the training videos are a great place to start, teaching you the basic controls for flight.

If you'd like, you can disable the Welcome Screen by unchecking the box labeled *Show this dialog on startup*. You may access the Welcome Screen at any time through the Help menu.

## The Main RealFlight Display-

RealFlight 9 is a menu-driven program. As seen in the picture below, a menu bar appears across the top of the RealFlight screen. Those menus contain additional sub-menu items and pull-down lists for the related options of the respective menu. These menus allow access to the command and control functions for the RealFlight 9 simulation.

### Navigating the Menus-

To access the various menu items, simply highlight and click the mouse on the menu that you would like to view. For example, clicking on the Aircraft menu activates the sub-menu items for that menu.



This manual includes a separate chapter for each menu title. Later chapters describe in detail all of the menu items, sub-menus and options.

Please note: It is also possible to access many of the features and functions of RealFlight 9 using hotkeys. Pressing the 'H' key on the keyboard activates the Keyboard Commands dialog, which summarizes the available hotkeys.

## Aircraft Selection-

When you start RealFlight 9 for the first time, you will be piloting E-Flite's incredibly popular Timber X. This is the default aircraft for RealFlight 9.

To select a different aircraft, click the **Aircraft** menu title in the main menu bar. Next, click the **Select Aircraft...** menu item found in the drop-down menu. This activates the Select Aircraft dialog (as shown below), which displays a list of available aircraft. To make it even easier than ever to select the most popular aircraft, we've placed the popular selections in the main RealFlight 9 folder. At the default, there is also a Legacy aircraft folder. While there are many modelers that like these aircraft, these are selections that may no longer be offered for sale (such as the Great Planes P-6E Hawk), or aircraft that have been included in a number of previous iterations of the software. Additionally, if you have created a custom model, or imported another RealFlight user's model into the simulation, it will appear in a Custom Aircraft folder accordingly.

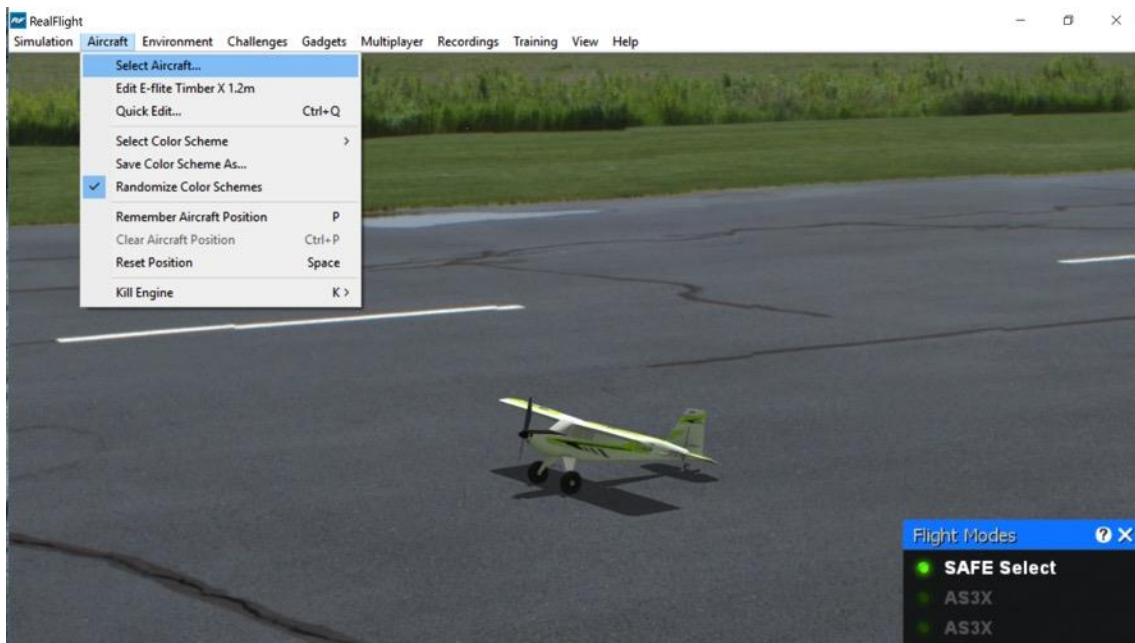

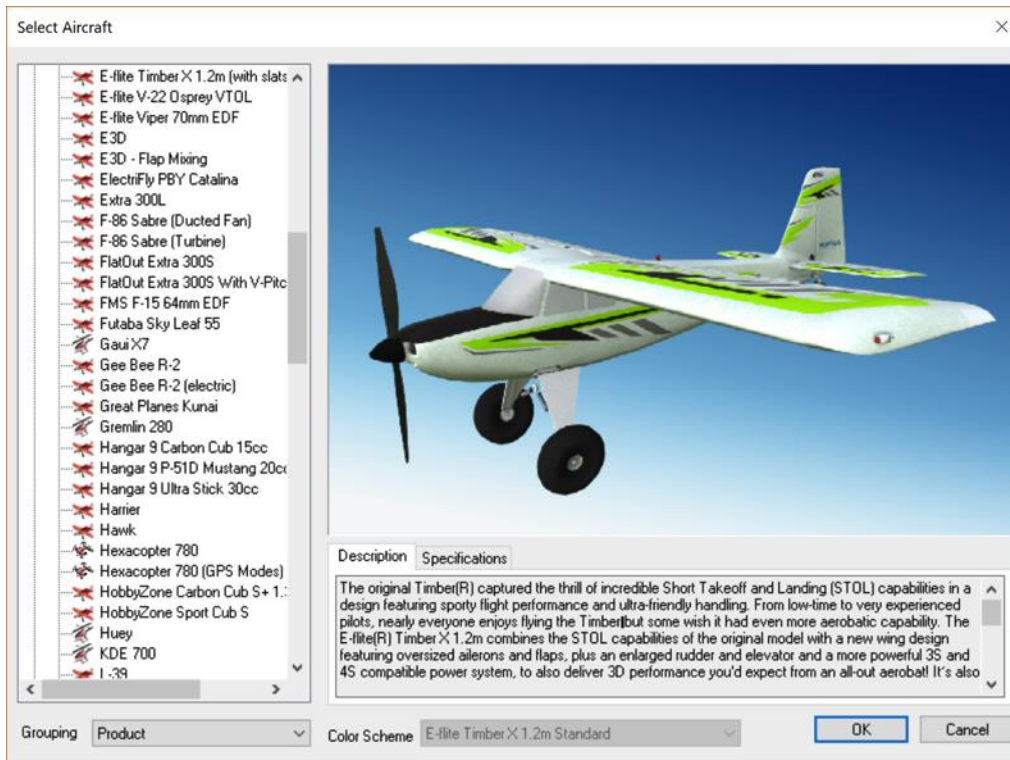

Each aircraft available is listed along the left-hand side within the selected folder. The icon next to each name differs depending on whether the model is an airplane, helicopter, or a drone. To select an aircraft from the list, click on the desired aircraft. The selected model will now appear in the ReadySelect™ preview box. Additionally, the aircraft's description and information data will appear in the aircraft information pane, which appears just below the ReadySelect preview window.

When you are satisfied with your selection, click **OK** to return to the simulator using the newly selected aircraft.

Complete information pertaining to the **Select Aircraft...** menu item is available in Chapter 6 of this manual, **The Aircraft Menu**.

Alternatively, you may use the InterLink DX controller to change aircraft selections. Simply press the **Scroll Wheel/Select** button located on the front of the InterLink DX controller. This will bring forth the QuickSelect tabs on the left side of the computer screen and the aircraft selection tab, represented as an airplane icon, should be the highlighted tab. If not, rotate the Scroll Wheel until the aircraft selection tab is highlighted. Press the **Scroll Wheel/Select** button once again to bring up the QuickSelect Aircraft Selection dialog box. Roll the Scroll Wheel left or right to view the available aircraft. To select an aircraft, simply highlight the name and press the **Scroll Wheel/Select** button once again. You will return to the simulation using the newly selected aircraft. Further instructions can be found on page 125.

If you wish to exit the Aircraft Selection screen without making any changes, simply press the **Reset** button on the left side of the InterLink DX controller.

### Aircraft Most Recently Used List (MRU)-

If you have selected any different aircraft previously, you will note that these aircraft appear on a list in the Aircraft menu; as shown below. This list is at the very bottom of the menu. This list is commonly referred to as a Most Recently Used, or MRU list. It is limited to the eight most recently used aircraft. If you wish to fly one of the aircraft from this list, simply click on the name of the aircraft in the MRU list.

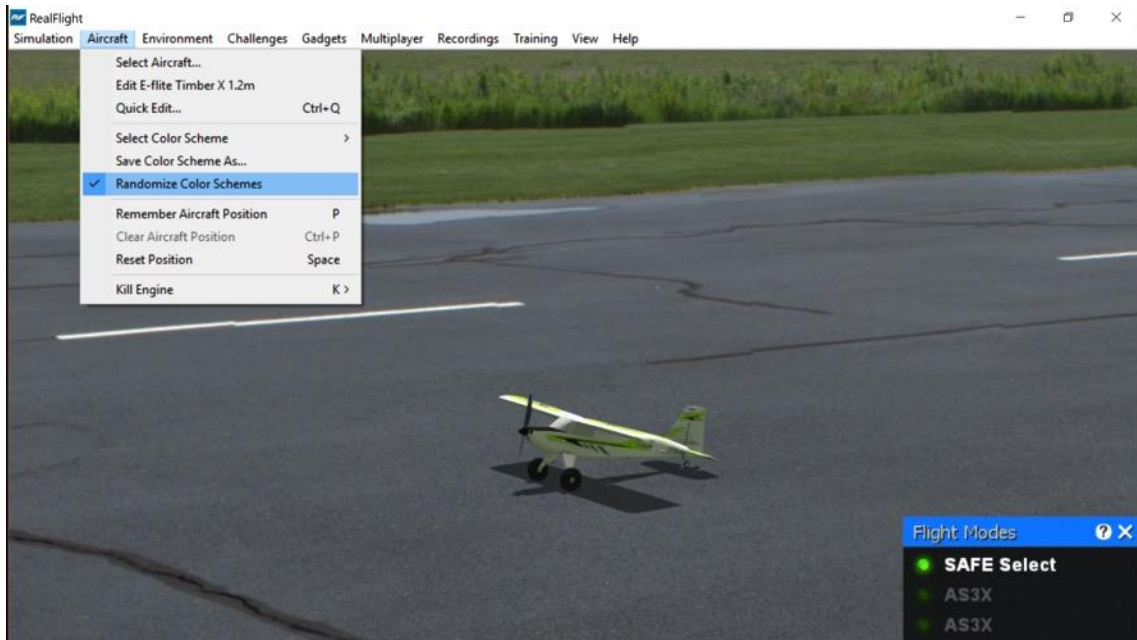



## Airport Selection-

Changing flying sites uses a process similar to selecting an aircraft. To select a new flying location, click the **Environment** menu title. Next, click the **Select Airport...** menu item found in the drop-down menu. This opens the Select Airport dialog. All the airports in RealFlight 9 are initially grouped by their respective location or scene: Archipelago, Flatlands, PhotoFields, or Sierra Nevada.

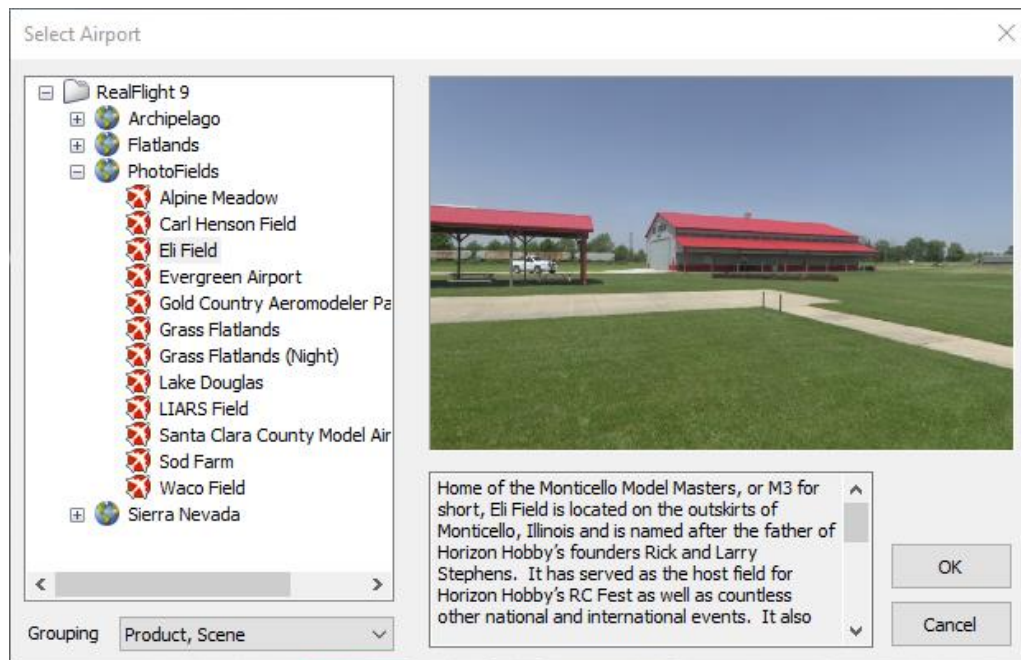

Some scenes are preceded by a [+] (plus) and an icon. The [+] (plus) indicates that another expansion level (selection) is available to you. To access the complete list of airports for a particular scene, either click the **[+] (plus)** or double-click on the name of the desired scene. For example, clicking the [+] (plus) next to the PhotoFields folder reveals all of the PhotoFields flying sites available to you.

To select an airport from the list, click on the desired airport. The selected airport will now appear in the preview box. Additionally, an airport description will appear in the information pane, which appears just below the preview window. When you are satisfied with your selection, click **OK** to return to the simulator using the new airport selection.

Navigating the Airport Selection menu using the QuickSelect feature is almost identical to the process mentioned previously for selecting aircraft. Only this time, you will select the Airport Selection menu, which is represented by a runway icon. With the QuickSelect tabs visible on the computer screen, roll the **Scroll Wheel/Select** to highlight the runway icon. Press the **Scroll Wheel/Select** button to bring forth the available flying sites. Using the same method,

as described previously for aircraft, select the new airport and press the **Scroll Wheel/Select** button to return to the simulation using this new flying site.

### Airport Most Recently Used List (MRU)-

If you have previously selected an alternative flying location, it will appear on a list in the Environment menu. This list is at the very bottom of the menu and is commonly referred to as a Most Recently Used, or MRU list. It is limited to the eight most recently selected locations. If you wish to fly at one of these locations, simply click on the respective location in the MRU list to load it into the simulation.

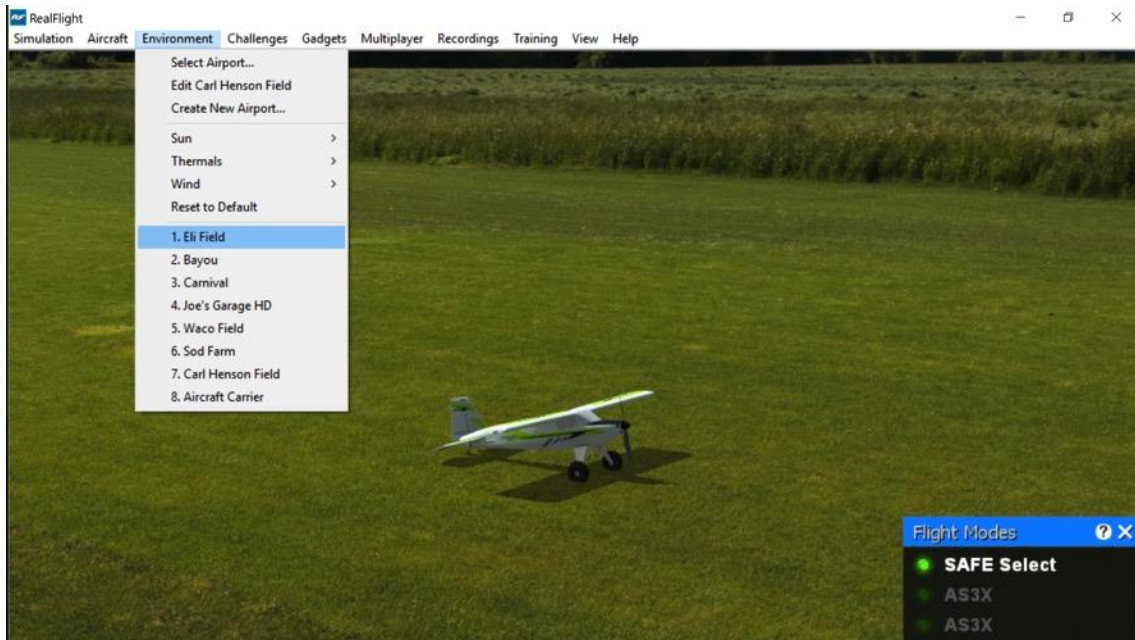

### QuickSelect Tabs-

If you have the InterLink DX controller, RealFlight 9 offers a revolutionary method for accessing many features and functions quickly and easily without ever touching the keyboard or mouse. There are seven main areas of access available through the QuickSelect tabs. They are: Scenario Selection, Aircraft Selection, Flying Site Selection, NavGuides, On-Screen Radio, Binocular view, and Viewport.

To access any of the QuickSelect tabs, press the **Scroll Wheel/Select** button on the InterLink DX controller. This will bring forth the available options on the left side of the computer screen. Roll the **Scroll Wheel/Select** left or right to cycle through the QuickSelect tabs. The highlighted tab is the item that is active. To access the active tab, press the **Scroll Wheel/Select** button.

You can also access the QuickSelect tabs with the mouse by moving the mouse cursor over to the left side of the screen. The QuickSelect tabs will appear and you may click on the desired icon.

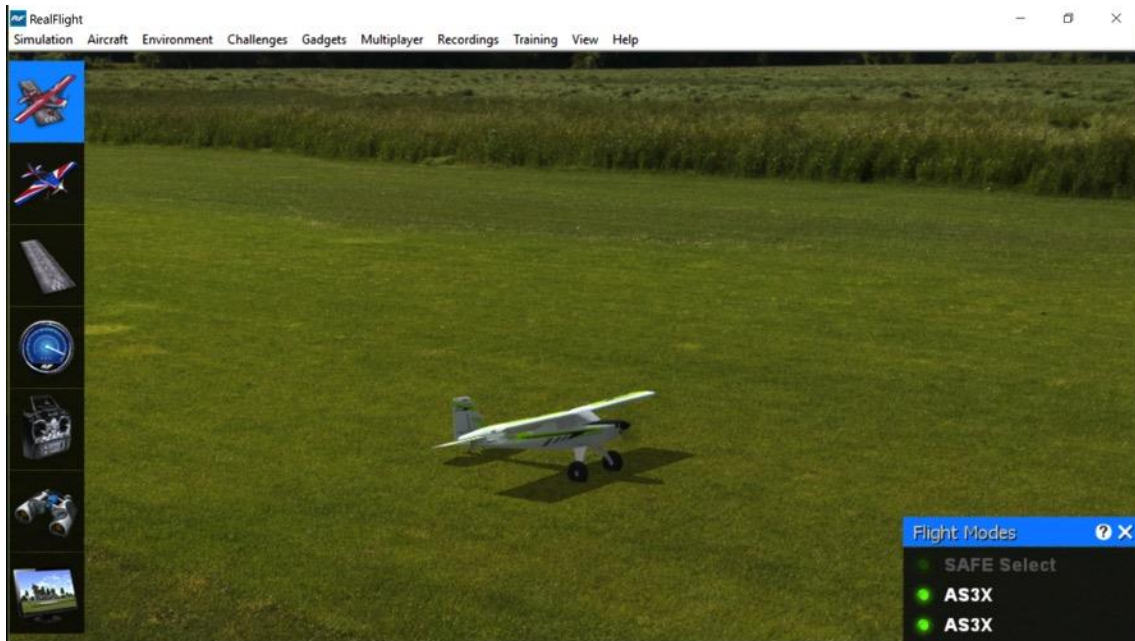

For additional information on how to use the QuickSelect tabs, please refer to the information contained in the section entitled QuickSelect- on page 46.

### Some Common Tasks-

- The easiest method of resetting your aircraft to its original takeoff position is to press the reset button located on the front of the InterLink DX controller. Alternatively, you can reset the aircraft by pressing the space bar on the keyboard, or by selecting the Reset Position menu item, which is located in the Aircraft menu.
- If your aircraft is equipped with smoke, Switch A located on the rear left corner of your InterLink DX controller will generally be utilized to activate this feature.
- To zoom in on an aircraft, press the **[+] (plus)** key on the number pad of the keyboard. Alternatively, you may use menu commands to zoom in. To do so, click on the **View** menu and then click on the **Zoom In** menu item. Each time the **[+] (plus)** key or the Zoom In menu item are pressed or selected, the view will increase incrementally.
- To zoom out of the current view, press the **[-] (minus)** key on the number pad of the keyboard. Alternatively, you may use menu commands to zoom out. To do so, click on the **View** menu and then click on the **Zoom Out** menu item. Every time you press **[-]**

(minus) key or select and press the Zoom Out menu item, the view will decrease incrementally.

- To reset the view to the default zoom level, press the **Backspace** on the keyboard.

Please Note: The Zoom keys are not always functional for all camera modes. Press **Z** or **C** on the keyboard to cycle through the different zoom and camera modes, respectively.

## Creating a Viewport-

RealFlight allows you to create an additional picture-in-picture viewport. Once you create a new viewport, you may resize or reposition it by dragging the mouse. You can also adjust all of the viewport's properties independently of the main window. The viewport may be utilized for a variety of applications, such as changing the viewing perspective of your simulation.

To create a new viewport, click the **Gadgets** menu title followed by the **Viewport** menu item. Alternatively, you may also press the '**4**' key on the keyboard to create an additional viewport.

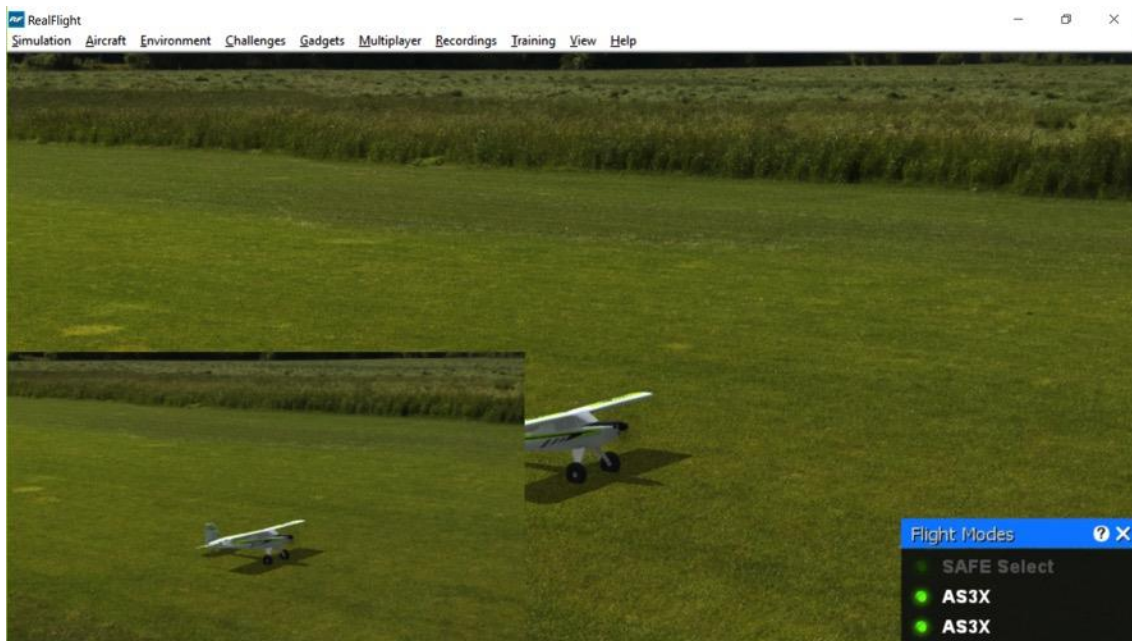

To change the vantage point within the active viewport, press the '**C**' key on the keyboard. This toggles through the various camera modes, one of which is the cockpit or pilot's perspective. Others include: chase view and a fixed viewpoint, or what you would see if you were standing at the side of the runway.

Please note: Depending upon the flying site selected, some of these viewing options may not be applicable.

Also, some aircraft include onboard cameras for additional viewing perspectives. The View chapter of this manual contains a thorough explanation of the viewport and camera options.

## Using Gadgets-

The RealFlight 9 software includes several gadgets that may be displayed in the main window when running the software. A gadget is an on-screen display that provides helpful information, or allows you to access to a variety of RealFlight features and functions.

For example, the NavGuides gadget displays continuously updated information relating to your aircraft's altitude, airspeed, directional heading, and other flight parameters. To display the NavGuides gadget, click the **Gadgets** menu title followed by the **NavGuides** gadget located in the drop-down menu. You may also access the NavGuides by pressing the numerical '1' key on your keyboard. Alternatively, you may activate the NavGuides through the QuickSelect tabs. To do so, press the **Scroll Wheel/Select** button on the InterLink DX controller. Next, roll the **Scroll Wheel/Select** to highlight the NavGuides icon. Finally, press the **Scroll Wheel/Select** button to activate the NavGuides.

When you select NavGuides, you should see the NavGuides gadget appear on your screen:

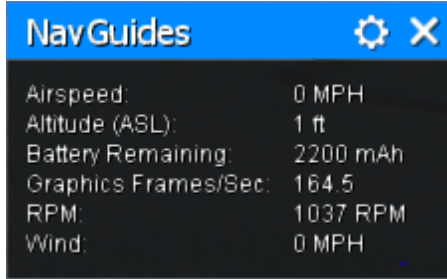

As discussed previously, you can customize the gadgets for personal preference. For complete information on how to do so, please refer to the chapter pertaining to the Gadgets menu options.

## Challenges-

RealFlight 9 offers a large number of challenges to help you test, refine and hone your flying skills. As you improve your skills and score well in the challenges, more levels become available, each progressing higher in difficulty.

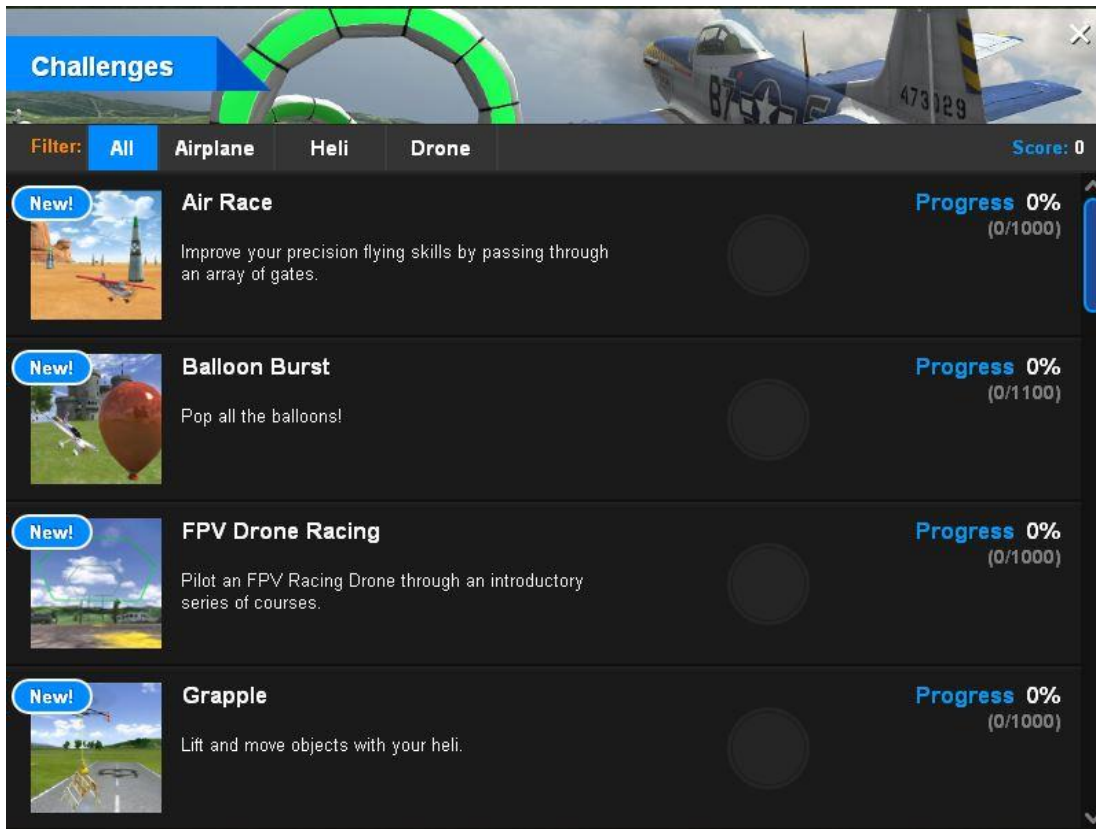

Do well in these challenges, and you may be rewarded for your efforts with new content, including new aircraft to fly.

## Airport Editing-

RealFlight 9 offers the most powerful, flexible flying site editor ever produced on an RC simulation. RealFlight 9's FlexiField editor allows you to completely customize virtually every aspect of your flying sites.



You can add, remove, change the orientation of, or resize virtually every aspect of your flying site. You can alter the position and orientation of the ground objects (such as runways) that 'snap' to the terrain—you can even have a runway running up a hill! It's even possible to control lighting, terrain, clouds, fog/haze, and much more. FlexiField provides you with almost unlimited freedom to create the flying environment you want. Moreover, when you've created an airport, you can share it with other RealFlight 9 users.

To learn more about the FlexiField flying site editor, please refer to the section titled *Edit Current Airport...* on page 156.

## Aircraft Editor-

RealFlight 9 also includes a powerful aircraft editor, allowing you full control over every aspect and parameters for an aircraft.

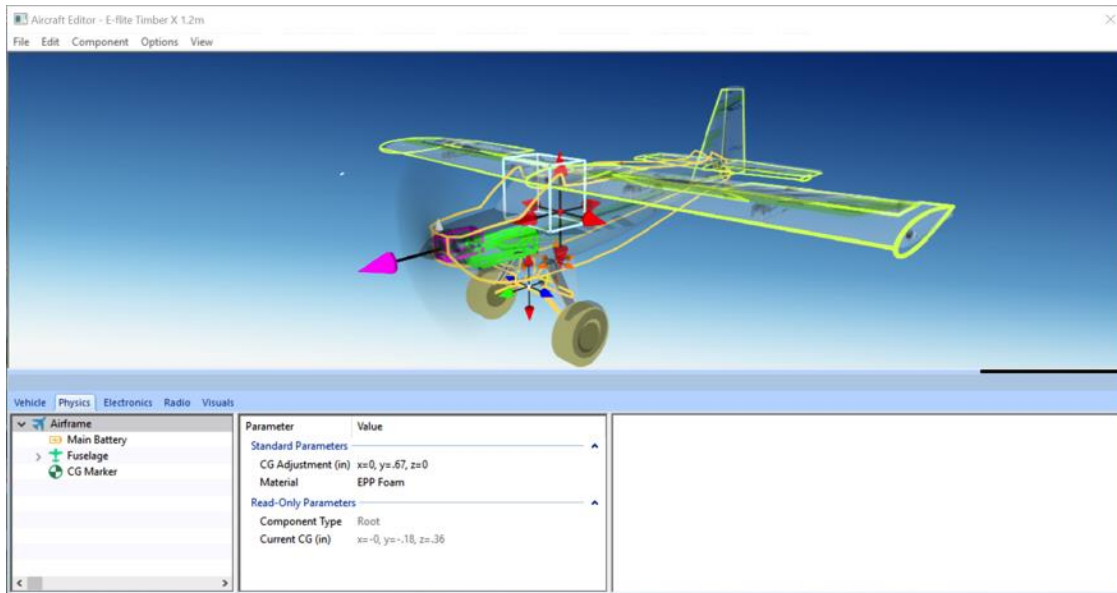

The Aircraft Editor allows you to make both simple and complex modifications to any aircraft. You could simply change the diameter of the wheel on the landing gear, or add new wings, streamers, or paintball guns. The possibilities are endless, and you can expect your modifications to accurately affect the behavior of your edited aircraft.

To learn more about the Aircraft Editor, refer to section *Edit Current Aircraft* on page 128.

To make simple refinements to the selected aircraft, we suggest utilizing RealFlight 9's Quick Edit feature. To do so, simply press '**Ctrl + Q**' on the keyboard. Make the desired changes, and then click **Save**.

For more information about the Quick Edit feature, see page 143.



## Multiplayer Contests-

RealFlight 9 offers multiplayer combat events. With an internet connection, you can challenge your neighbor next door, friends from the local RC club, or anyone, anywhere in the world.

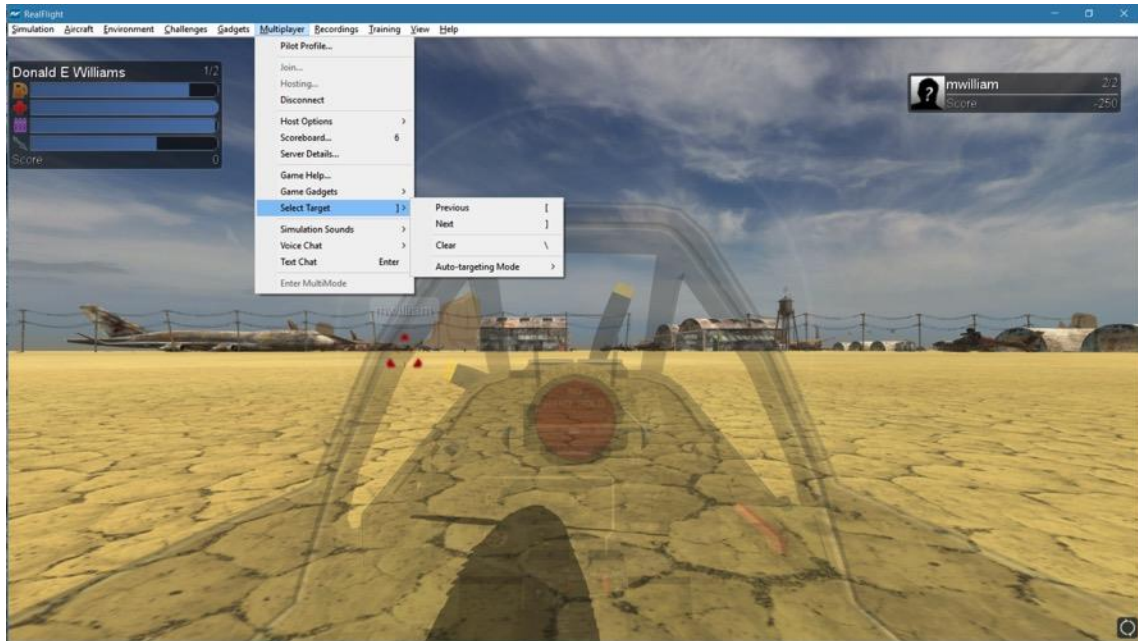

Multiplayer contests include: Fun Fly, Deadringer, Combat, Streamer Cut, Paintball, and Rocket Wars on a variety of different aircraft. Up to 32 people can participate in a multiplayer session. RealFlight also offers a way to automate contests into events, so the host can spend more time enjoying RealFlight.

To quickly join a public multiplayer session, click the **Multiplayer** menu followed by the **Join...** menu item. On the dialog window that appears, select a multiplayer session from the list and click **Connect**.

For more information about multiplayer and combat events, check out Chapter 10 on the Multiplayer Menu.

## Keyboard Commands

Many options throughout RealFlight may be activated quickly by a simple press of a key on the keyboard. Below is a list of functions and their related keys. You may also access this list in the simulator by pressing 'H' on the keyboard.

### Virtual Channels-

Channel 5	Y
Channel 6	U
Channel 7	I
Channel 8	O
Channel 9	J

### Gadget Commands -

NavGuide Gadget	1
Radio Gadget	2
Binocular Gadget	3
Viewport Gadget	4
Variometer Gadget	5
Multiplayer Gadget	6
Overhead Gadget	7
Timer Gadget	8
Heads-Up Display	9
Flight Modes Gadget	0
Console Gadget	~
Chat Gadget	Enter

### View Commands -

Reset Aircraft	Space
Zoom Reset	Backspace
Zoom In	+
Zoom Out	-
Quick Look at Windsock	Up Arrow
Quick Look at Ground	Down Arrow
Fixed Camera	F1
Nose Camera	F2
Chase Camera	F3
Onboard Cameras	F4-F10
Set Viewport Camera	Ctrl + F1-F10
Change Camera Mode	C

Follow Camera	Shift + C
Pivot Camera	E
Orbit Camera	Ctrl + E
Select Pit Position	X
Select Previous Pit Position	Shift + X
Select Default Pit Position	Ctrl + X
Change Zoom Mode	Z
Change Movement Mode	Q

### **Movement Commands –**

Move Forward	W
Move Backwards	S
Move Left	A
Move Right	D
Move Slow	Ctrl
Move Fast	Shift
Move Very Fast	Shift + Ctrl

### **Environment Commands –**

Increase Wind Direction	Home
Decrease Wind Direction	End
Increase Wind Speed	Page Up
Decrease Wind Speed	Page Down
Increase Turbulence	Insert
Decrease Turbulence	Delete
Increase Sun Azimuth	Shift + Home
Decrease Sun Azimuth	Shift + End
Increase Sun Inclination	Shift + Page Up
Decrease Sun Inclination	Shift + Page Down

### **Miscellaneous Commands –**

Take Screenshot	Tab
Toggle Microphone On/Off	V
Kill Engine	K
Start/Stop Recording	R
Look at Next Aircraft	T
Look at Previous Aircraft	Shift + T
Look at My Aircraft	Ctrl + T
Remember Aircraft Position	P

Clear Position	Ctrl + P
Flight Failures	F
Quick Load Gadget	Ctrl + F
Quick Edit Gadget	Ctrl + Q
Mute/Unmute Audio	M
Toggle Full Screen Mode	Alt + Enter
View Keyboard Commands	H
Copy Messages to Clipboard	Ctrl + C
Steam Overlay	Shift + Tab

#### **Game Commands –**

Target Previous Aircraft	[
Target Next Aircraft	]
Clear Target	\
Toggle Padlock View	/

## **Where to Go From Here**

The examples in this chapter only scratch the surface of RealFlight 9's unparalleled capabilities. We encourage you to explore RealFlight 9 using some of the methods below.

- Browse through the menus. Many of the menus are self-explanatory, providing you with a more thorough look at the software. If you're adventuresome, dive right in and start making modifications to an aircraft or a flying site! It's a great way to learn more about what makes the RealFlight 9 RC Flight Simulator tick!
- If you'd like to learn more about a particular menu or item, look it up in the table of contents.
- If you would like RealFlight 9 to perform a certain function but cannot locate the appropriate command, check the index.
- Use the Help option in RealFlight's Help menu.
- Talk to other RealFlight users at [www.knifeedge.com/forums](http://www.knifeedge.com/forums).

## Controlling RealFlight 9

*FLY WITH THE INTERLINK DX, YOUR SPEKTRUM DSM2/DSMX TRANSMITTER, THE TACTIC TTX610, OR WITH YOUR OWN RADIO.*

**T**he RC transmitter is a key component in all types of RC flying. This unique method of control is part of what separates RC from every other type of aviation. Consequently, a realistically simulated transmitter is an important key to an authentic simulation of the RC experience.

With this in mind, we at Horizon Hobby are proud to offer many choices to control the RealFlight 9 RC Flight Simulator software. Our revolutionary USB InterLink DX (U.S. Patent #6,842,804 and #7,010,628) controller, is the most popular option. The InterLink DX controller was designed from the ground up to meet the needs of the RC purist. We believe that no other RC simulator control method goes further to enrich your RC simulator experience.



### Wireless Simulator Dongle

The Spektrum WS2000 Wireless Simulator Dongle (SPMWS2000) is another popular option, enabling you to control RealFlight aircraft with your Spektrum DSM2 or DSMX-compatible transmitter.



The previously offered RealFlight wireless interface option is also functional with RealFlight 9. This allows you to fly using your own SLT transmitter, or a transmitter equipped with an AnyLink/AnyLink2 adapter.



Additionally, the previously offered, RealFlight wired interface option allows you to utilize RealFlight 9 by connecting to your transmitter's trainer port.



## Features of the InterLink DX Controller-

- USB compatibility and convenience. The InterLink DX offers the “plug and play” convenience, “hot pluggable” installation and removal, as well as the high-speed digital performance made possible by Universal Serial Bus (USB) technology.
- High quality “mockup” transmitter. Use the InterLink DX controller by itself as a pseudo RC transmitter, with the controls you expect in a standard RC radio. The mockup transmitter features two 2-position switches, five 3-position switches, a rotary knob, two sliders, a push-button, and knurled control sticks with adjustable length, tension and ratchet availability.
- Built-in transmitter interface. If you so choose, you can use your own FM or FM-compatible RC transmitter to control RealFlight, using the InterLink DX controller’s built-in interface. You can even switch back and forth between the pseudo controller and your own transmitter! Interface adapter cords are available separately that are for use with most Spektrum, Tactic, JR and Futaba transmitters.
- QuickSelect menu controls. With the InterLink DX, you’re able to make a variety of common adjustments to the simulator (such as selecting a different aircraft or airport) without having to touch the keyboard and mouse.
- Easy setup and use. Simply plug it in and go!
- Simulate sophisticated computer radios. The InterLink DX, used in conjunction with the RealFlight software, allows you to simulate the programmability (mixing, exponential, etc.) of sophisticated computer radios.

## Features of the Spektrum WS2000 Wireless Simulator Dongle-

- USB compatibility and convenience. The dongle offers the “plug and play” convenience.
- No wires to tether you to the computer. Complete freedom to sit back and enjoy the RealFlight experience with your Spektrum DSM2 or DSMX-compatible transmitter.
- Gain confidence in the programming of your applicable Spektrum transmitter.
- Become acquainted with not only the location of the respective switches, buttons, etc. found on your Spektrum transmitter but also the ‘feel’ of the transmitter in your hands.

## Features of the RealFlight wireless SLT interface-

- USB compatibility and convenience. The interface offers the “plug and play” convenience.

- No wires to tether you to the computer. Complete freedom to sit back and enjoy the RealFlight experience.
- Compatible with Tactic’s SLT protocol. Any radio that transmits using the SLT protocol will work perfectly with the wireless interface. Radios without SLT can utilize an AnyLink or AnyLink2 adapter.

### Features of the RealFlight wired interface-

- USB compatibility and convenience. The interface offers the “plug and play” convenience, “hot pluggable” installation and removal, as well as the high-speed digital performance made possible by Universal Serial Bus (USB) technology.
- Use your own FM or FM-compatible RC transmitter to control RealFlight. Interface adapter cords are included for most Spektrum, Tactic, JR and Futaba transmitters.
- Reset/Rewind – We brought the best function of the previous InterLink to the RealFlight interface with the Reset/Rewind button. With the interface near hand, there is no need to reach for the keyboard.

## Start Flying!

When you start RealFlight for the first time, the software will automatically detect the InterLink DX controller. When you close the Welcome Screen, simply add throttle and start flying right away. Note: In order to obtain the best flying experience possible, we strongly suggest that you calibrate the InterLink DX controller accordingly. Information on how to do so may be found on page 57 of this manual.

If you are flying with your own radio with the RealFlight interface, or through the InterLink DX, please refer to the Select Controller section on page 53.

### QuickSelect-

The InterLink DX also offers QuickSelect buttons located on the controller. These buttons allow you to make simple changes to the simulator without having to put the controller down and reach for the keyboard or mouse. This makes it convenient to change the current aircraft and airport, or display popular on-screen gadgets.

To access the QuickSelect tabs, press the **Scroll Wheel/Select** to display a number of tabs along the left side of the simulator. Roll the scroll wheel to rotate through these options. Pressing the **Scroll Wheel/Select** once again will select the highlighted tab. Pressing the **Cancel** button on the InterLink DX will exit out of the tabs and hide them.





Select Scenario



Select Aircraft



Select Airport



NavGuides Gadget



Radio Gadget



Binocular View



Viewport

When using the QuickSelect buttons in the Select Aircraft or Select Airport dialog screen, press the **Scroll Wheel/Select** to select the highlighted item. Pressing **Cancel** on the InterLink DX will move you up a level, so you can quickly change folders. To exit out of these dialog screens without making any changes, simply press the **Reset** button.



Look for the icon to the left throughout this manual for suggestions on when to use the QuickSelect buttons.



# The Simulation Menu

*ALLOWS ACCESS TO A VARIETY OF SIMULATION-RELATED FEATURES, FUNCTIONS AND OPTIONS.*

The Simulation menu gives you access to many simulator related features, such as adjusting physics parameters, changing simulator settings, or importing and exporting RealFlight files.

Clicking the Simulation menu will open the drop-down menu as illustrated in the following screen shot.



## Select Scenario...

Often times you'll find yourself wanting to fly a particular aircraft at just the right flying site under the perfect conditions. For example, you may wish to fly a glider along a cliff with the winds just right for soaring. RealFlight offers many of these scenarios pre-configured to save you time.

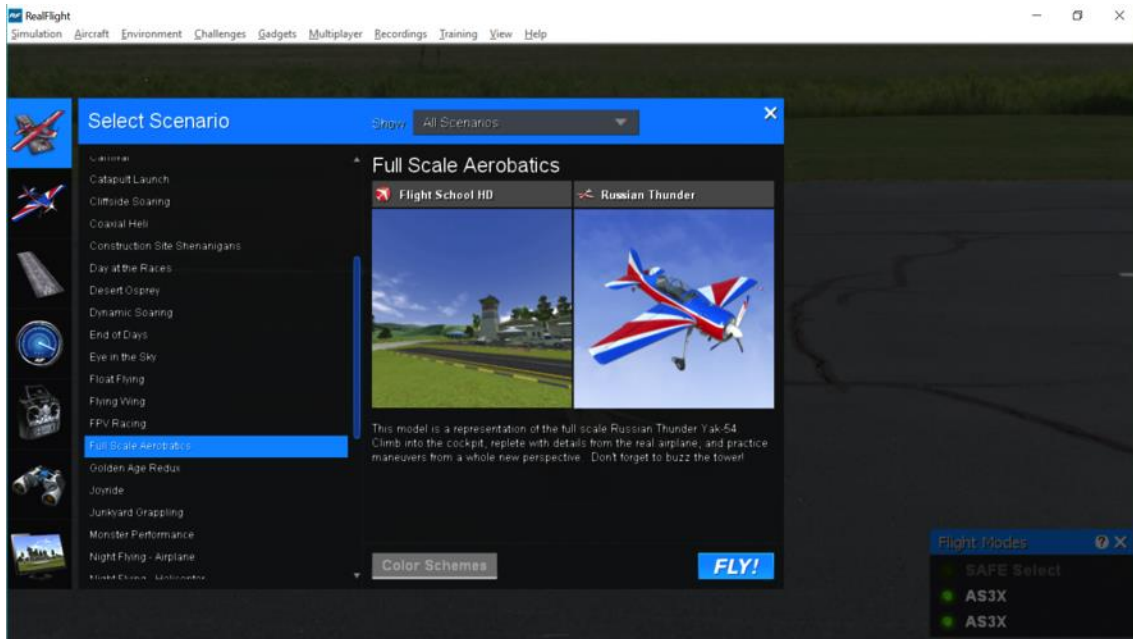

Choosing the Select Scenario... menu item from the Simulation menu will display a dialog window with many scenario options listed for your convenience. For slope soaring along the cliff, you might select Cliffsides Soaring to fly the Mistral 3m at the Sierra Nevada Cliff airport.



Change scenarios by using the InterLink DX. Press the **Scroll Wheel/Select**, then, with the scenario tab highlighted, press the **Scroll Wheel/Select** once again. This will bring up the Select Scenario QuickSelect dialog window. Roll the scroll wheel to scroll through the scenarios accordingly, use the **Scroll Wheel/Select** to choose a new scenario, or press **Reset** to resume flying without making any changes.

## Manage Scenarios...

If you wish to create and edit Scenarios to your own tastes, choose **Manage Scenarios** from the **Simulation** menu. Doing so will display the following dialog:

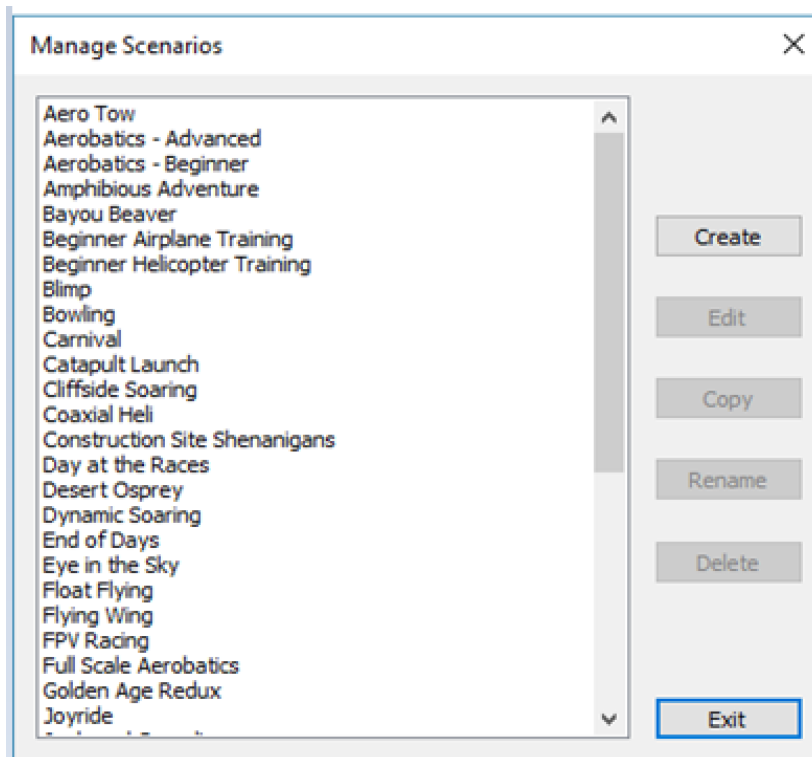

The list on the left displays all the scenarios currently accessible to you. On the right are all the actions that are available to you. They include:

- **Create** – This button allows you to create a brand new scenario.
- **Edit** – This allows you to make changes to the selected scenario from the list.
- **Copy** – If you wish to make a new scenario with the same parameters, select it from the list and then click copy. This is a quick way to make a new scenario that you like but would like to make only minor changes, instead of creating a new one.

- **Rename** – Use this to rename a selected scenario. This option is only available to scenarios that you create. You cannot rename stock scenarios.
- **Delete** – As the name implies, choose this to delete a scenario. Like rename, this is not available if a stock scenario is selected.

When you click **Create** or **Edit**, the following dialog window will appear:

This window allows you to select and change all parameters associated to a scenario. They include:

- **Airport** – Press the ... button to choose an airport.
- **Aircraft** – Press the ... button to choose an aircraft for this scenario.
- **Color Scheme** – If the aircraft you selected is available in multiple trim schemes, you may select the default for this scenario from the drop down list.
- **Description** – As the name implies, this field allows you to type up a short message that describes the scenario.

By clicking the **Advanced Options**, two more parameters will be available to you if you choose a 3D airport (not PhotoField). They include:

- Starting Position – Some 3D airports have multiple locations from which you can start your flight. Choose the location you wish to be the default for the scenario from this drop down list.
- Camera Type – When flying at 3D airports, you have the option to change your camera location. You may change the default for your scenario from this drop down list.

Finally, click **Save**, to save your changes to the current scenario. If you are editing a stock scenario, this option is unavailable. Clicking **Save As** allows you to save under a different name. If you wish to quit or return to the Manage Scenarios window without saving any changes, simply click the **Exit** button.

## Select Controller...

RealFlight 9 is offered in several different iterations, allowing you to control the aircraft in a variety of ways. This includes, but is not limited to the InterLink DX or Software Only, versions. It is also compatible with previous control methodologies such as those mentioned previously. To assist you, RealFlight includes features to help walk you through setting up your choice of controller.



After clicking **Select Controller...**, a new window appears with all the controllers available to you. For many users, you will only see one controller listed. If you happen to have a real transmitter plugged into the InterLink DX, for example, your screen may look something like the following:

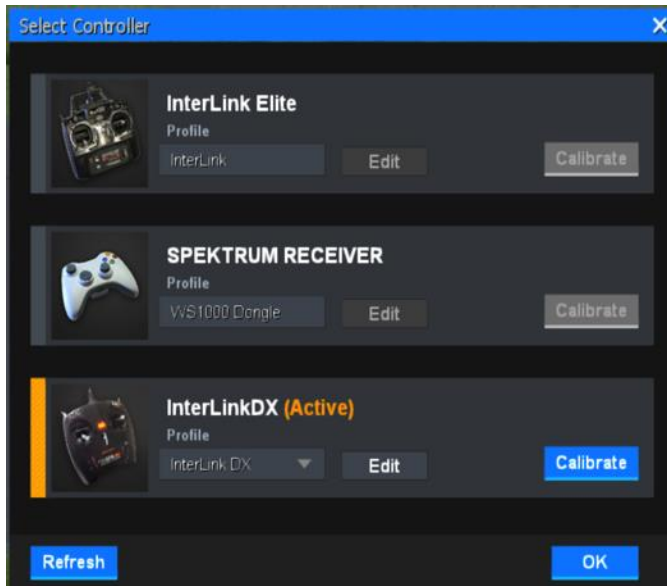

The controller that is currently in use for flight will have an orange bar next to it as well as “(Active)” next to the name. A few options are available to you from this window:

- Profile – RealFlight allows you to save profiles for the different radios you might want to fly with. Choose the profile that best matches your controller from this drop-down list.
- Edit – Clicking Edit on the Active controller will open a new screen that gives you access to modify and adjust the controller’s channels and other parameters. See below for more information.
- Bind – If you are using the RealFlight wireless interface, you will see that a Bind button is available. To bind your radio to the wireless interface, make sure the radio is switched On, then click the Bind button.
- Calibrate – To ensure that your controller is properly calibrated to fly aircraft in RealFlight, click Calibrate on the Active controller. Additional information about the calibration process is found below.
- Refresh – If, at any time, you plugged in a radio and turned it On while this screen is visible, click Refresh to update the list. Doing so should include your new controller method.



To switch the Active controller, simply click on an available controller listed. You will see the orange selection bar switch to the new controller as well as “(Active)” appear next to the name.

There are hundreds of radios that are compatible with RealFlight, but not all of them function exactly the same. Some may have a different channel order, or possibly the channel input is reversed. To assist you with making, changing and saving these settings, RealFlight offers controller Profiles.

## Edit-

If you wish to use a radio that is not listed in the Profile drop down list, pick something similar, then click **Edit**. The following screen will appear:

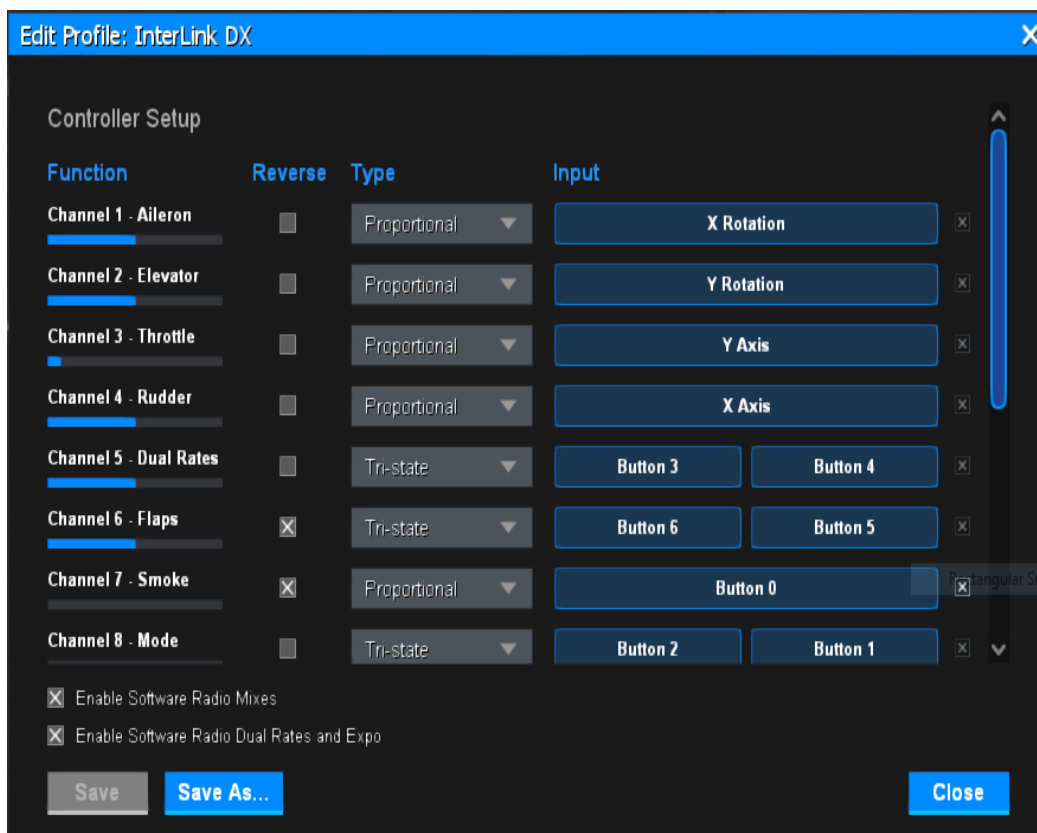

The four columns visible include:

- **Function** – This is the list of channels that RealFlight uses for its aircraft. These cannot be modified. Below each function is a bar. These bars show the current value for each input channel. For example, if you move the throttle stick on your controller, the associated bar will move.

- Reverse – Check this box to reverse the output direction of a channel.
- Type- This indicates the switch, button, etc. that is associated with a given channel. There are three options- proportional, toggle and tri-state. Proportional, as the name suggests, indicates that a given channel is proportionally controlled in the movement. Similarly, Channel 8, in an aircraft equipped with SAFE/AS3X, offers a tri-state functionality- switching amongst SAFE/AS3X offerings accordingly.
- Value – The bars that appear in this column show the current value for each input channel. For example, if you move the throttle stick on your controller, the associated bar will move.
- Input Channel – This is the channel on your radio that is assigned to the Function column.

Using the information from these columns, you can edit the channel lineup to match your radio. For example, if your radio outputs the throttle on channel 1, you will follow these steps to correctly assign it to RealFlight’s throttle:

1. Find “3 Throttle” from the Function column.
2. Click the corresponding Input button.
3. Move the throttle stick to connect your radio’s Input to the Function.

Repeat for all other channels you wish to reassign.

#### *Enable Software Radio Mixes-*

By default, RealFlight will handle all channel mixing in each aircraft. This is the simplest method to fly in RealFlight. In this mode, you should not have any mixing programmed into your radio, otherwise channels will be mixed twice; once by your radio and then by RealFlight. If you wish to use the mixing programmed in your radio, uncheck the box **Enable Software Radio Mixes**.

#### *Enable Software Radio Dual Rates and Expo-*

Some radios allow you to program the expos and dual rates on your transmitter. If you prefer this method, make sure **Enable Software Radio Dual Rates and Expo** is unchecked.

If you are flying with the InterLink DX, or with a radio that does not offer this functionality, you will want to enable this feature. Then, make sure you assign a channel to “5 Dual Rates” in the channel assignments above. RealFlight will then handle all rates and expos for you.

#### *Save and Save As-*

After making changes to your controller profile, you will want to save all modifications. Note that you cannot make changes to stock profiles that are included with RealFlight. If you made changes to a stock profile, the **Save** button will be disabled. Click the **Save As** button to save the profile under a different name.

#### **Calibrate-**

Clicking the **Calibrate** button on the Active controller allows you to adjust and fine-tune the controller input for the simulation, so that you will achieve the desired responses. Once clicked, the following screen appears:

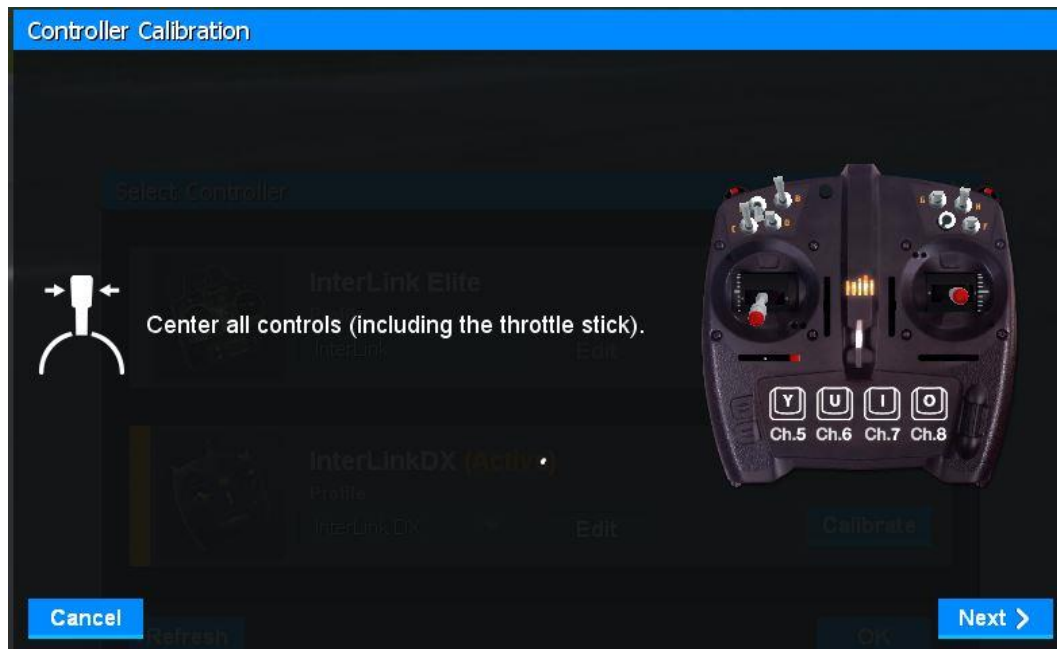

As directed, place all sticks to their center positions. Click **Next** when finished.

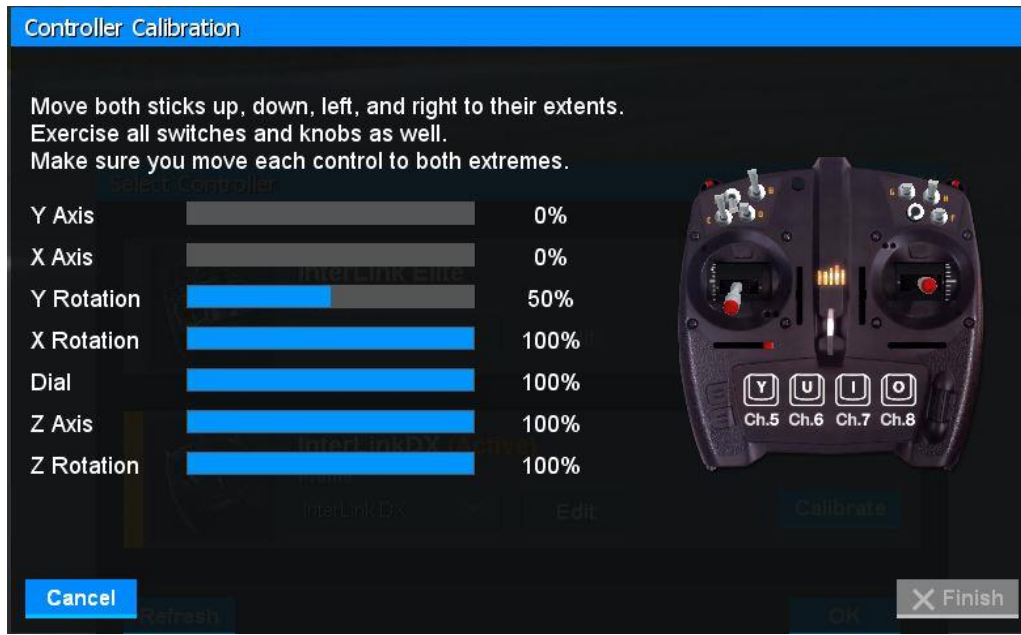

It is imperative to move all of the sticks, knobs, sliders and switches through their complete range of motion several times. This is the key to a properly calibrated controller- and thus, precision flight. When completed, click **Finish**. You will now be returned to the Select Controller screen with a calibrated controller.

#### *Virtual Channels-*

Many aircraft that are included with RealFlight, as well as user created aircraft, require 5, 6, 7 or even 8 channels to completely operate them effectively. Some radios have fewer channels. If you are flying with a radio that has fewer channels than the currently selected aircraft requires, you can use the keyboard.

Channel 5 Key: Y

Pressing **Y** will act like a two-position switch. Press the key to flip the switch to its opposite position.

Channel 6 Key: U

Pressing **U** will activate the knob to one extreme or the other, while holding the key down will slowly rotate the knob.

Channel 7 Key: I

Pressing **I** will act like a two-position switch. Press the key to flip the switch to its opposite position.

Channel 8 Key: O

Pressing **O** will act like a three-position switch. A quick press of the key will flip the switch to one extreme or the other, while holding the key down will place the switch to its center position.

Channel 9 Key: J

Pressing **J** will act like a two-position switch. Press the key to flip the switch to its opposite position.

It might help to display the Radio Gadget to view these channels in action and to assist you in learning how they function.

## Physics...

One of the great benefits of RealFlight 9 is the ability to adjust features and settings that you would not be able to do at a real flying field. The Physics setting is one of these great features. It allows you to adjust how realistic the flight physics are in the simulator on a global scale, meaning that all of the simulator's characteristics reflect this modification. The options that are available are as follows:



### Beginner-

This setting is perfect for the first time pilot. It reduces the speed of the physics to allow a beginner time to react and learn how an aircraft is controlled. At this level, you cannot run out of fuel, and crashes are more forgiving.

### Intermediate-

Crashes are not as forgiving, and aircraft will run out of fuel just as they would at the field.

### Realistic-

By default, RealFlight 9 is set to Realistic. As the name implies, this setting accurately reflects the flight performance of their real-world RC counterparts. The flight physics level for Realistic is very similar to Intermediate. However, you will notice that the severity of the stalls has also increased; forcing the pilot to react faster to stalls and other similar flight characteristics.

### Custom-

Custom will be selected if you made changes to the default settings for physics speed, flight model, autopilot assist or fuel consumption. If you wish to adjust the physics parameters to fit your skill level, click the Custom Tab at the top of the Physics gadget. The following options are available.



- **Physics Speed** – Expressed as a percentage, this value controls the time scale of the simulation. Reducing the value allows you to create a slow-motion effect. This is useful when learning new skills or practicing difficult maneuvers; slowing the aircraft’s reaction time.
- **Flight Model** – This setting can range from “Easy” to “Realistic”. At an Easy setting, the aircraft are easier to fly than in real life. This is especially true at slow speeds. If set to Realistic, RealFlight 9 simulates real life aerodynamics in every way, including abrupt loss of lift during an aerodynamic stall. Setting the Flight Model to something in between will provide a compromise.
- **Autopilot Assist** – This setting improves overall stability of the aircraft. Much like the Active Flight Stabilization found on Hobbico’s NexSTAR, the Autopilot Assist will attempt basic wing leveling when you release the control sticks. For helis, the Autopilot Assist manages the collective to resist crashes. The strength of the assistance is inversely proportional to the aircraft’s height above the terrain, meaning that it will let you mess up a bit but will try to keep you from actually colliding with the ground.
- **Unlimited Fuel** – This option determines whether or not your aircraft will run out of fuel. If selected, the engine will run indefinitely – assuming, of course, that you do not crash. If disabled, the aircraft will indeed run out of fuel. The length of time required to do so is based upon a number of factors including the engine utilized and throttle management, just as it would be at the flying field.

## Graphics...

Not all computers are created equal. You might find that RealFlight will perform better if you reduce the graphics quality of the simulator. Alternatively, if you have a high-end computer, you might enjoy the visualizations better by increasing the graphics quality.



At the bottom of the Graphics Quality Settings dialog, you will notice a slider. Moving this from Low to Highest will alter the screen shot displayed above the slider, depicting the current selection. If you find RealFlight is not performing at its peak, try reducing these settings.

The slider will be set at Custom if you decide to alter individual graphics parameters in the Settings dialog. See Settings on page 81 for more information.



## Flight Failures

RealFlight 9 offers the ability to simulate common failures for your aircraft. Flight Failures aid in teaching you how to remain calm and react appropriately when an actual failure occurs during flight. RealFlight 9 allows you to determine the types of flight failures that you will face, as well as how often these failures will occur.

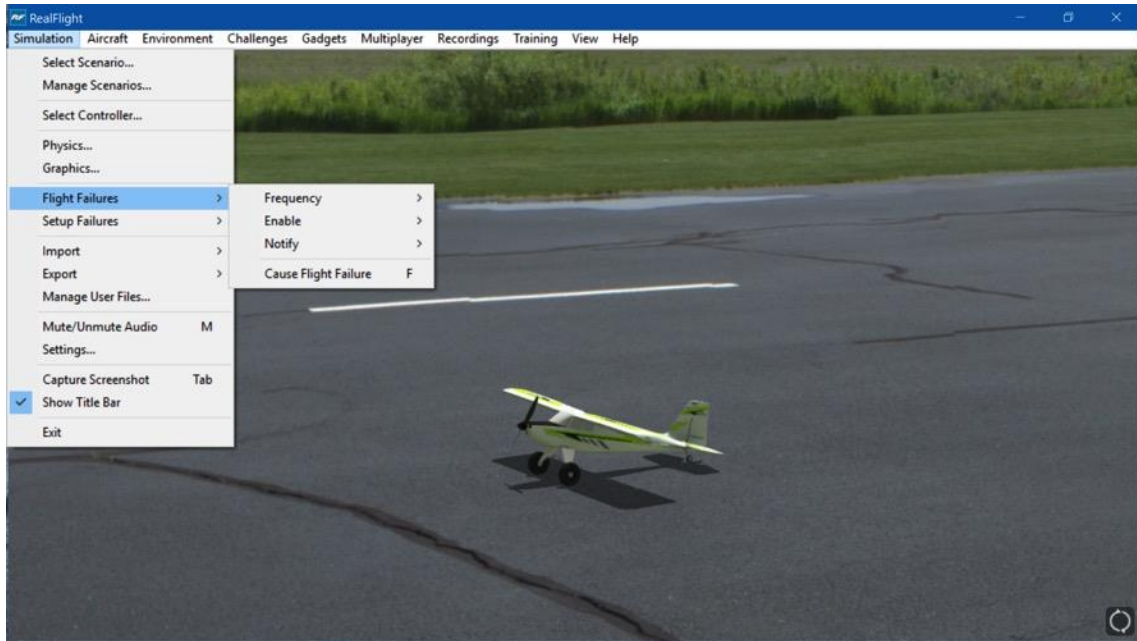

### Adjust the Rate of Occurrence-

To reduce the frequency of flight failures, click on the **Simulation** menu followed by the **Flight Failures** menu item, and then the **Frequency** menu item. This brings up a sub-menu as shown in the screen below. Once the sub-menu is visible, simply mouse click on one of the options in the pull-down menu.

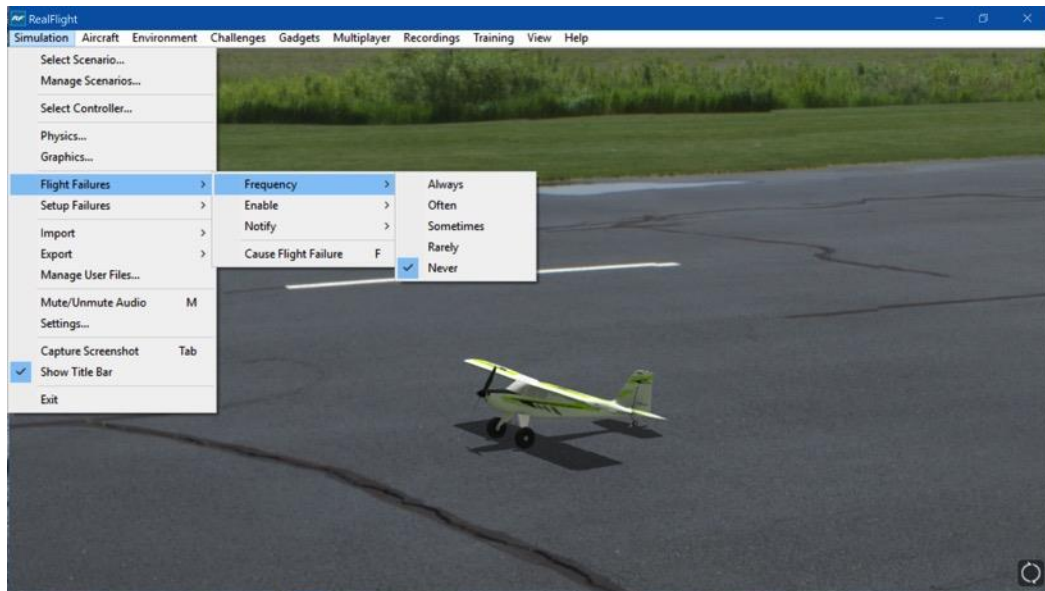

If you do not wish to experience any flight failures, click the **Never** option in the drop-down menu or, if you wish to gain a great deal of experience at handling emergencies, click the **Always** option.

### Selecting the Type of Flight Failures-

RealFlight allows you to determine the type of flight failures that you will experience within the simulation. To do so, click the **Simulation** menu followed by the **Flight Failures** menu item. Next, select **Enable** to bring forth the list of available flight failures. If an item has a check mark next to it, then that flight failure is enabled. To toggle the flight failure, click on it with the mouse.

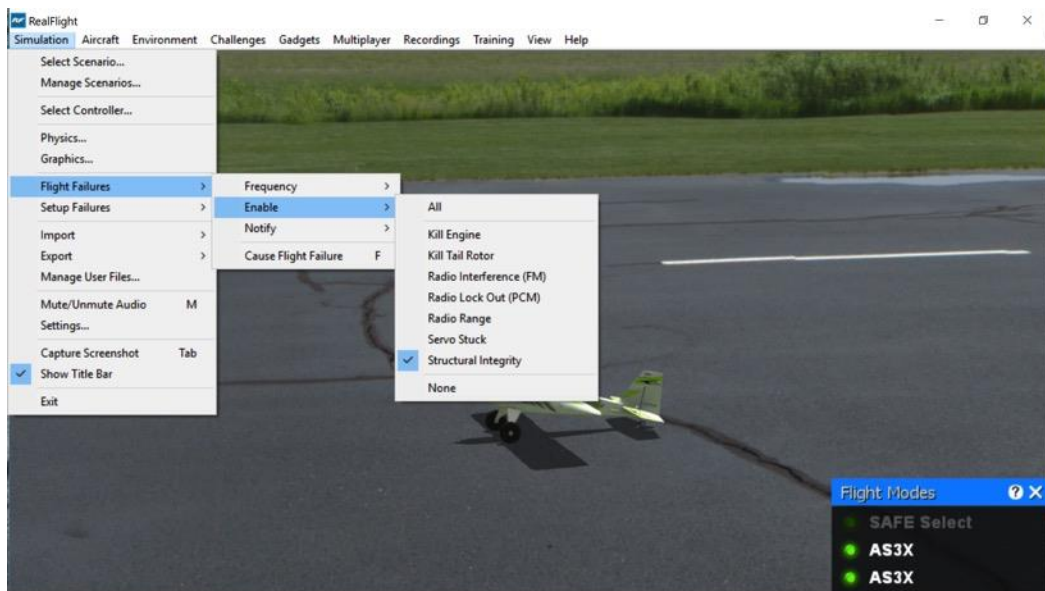

The options for Flight Failures consist of:

- All- The simulation will utilize all applicable flight failures. This means that the engine might die, the aircraft could experience a structural failure, and so on.
- Kill Engine - The engine will fail or quit in flight, which means that you will have to perform a deadstick landing or autorotation.
- Kill Tail Rotor (heli only) – This failure will cause the tail rotor of the heli to stop functioning during flight.
- Radio Interference (FM) - The receiver will experience intermittent radio interference during which the servos will behave erratically.
- Radio Lockout (PCM) - The receiver will experience intermittent radio dropouts during which the aircraft will fail to respond to control inputs.
- Radio Range - The receiver will experience interference proportional to the distance between the pilot and the aircraft. If the aircraft is close to the pilot's position, the range problems will be minimal, increasing as the aircraft gets farther away.
- Servo Stuck - A servo will become fixed, or stuck, in a certain position.
- Structural Integrity – This failure determines how strong the aircraft is and if parts could break off during flight.

#### **Notify -**

This setting allows you to determine if, or when, RealFlight notifies you as to the flight failure experienced.

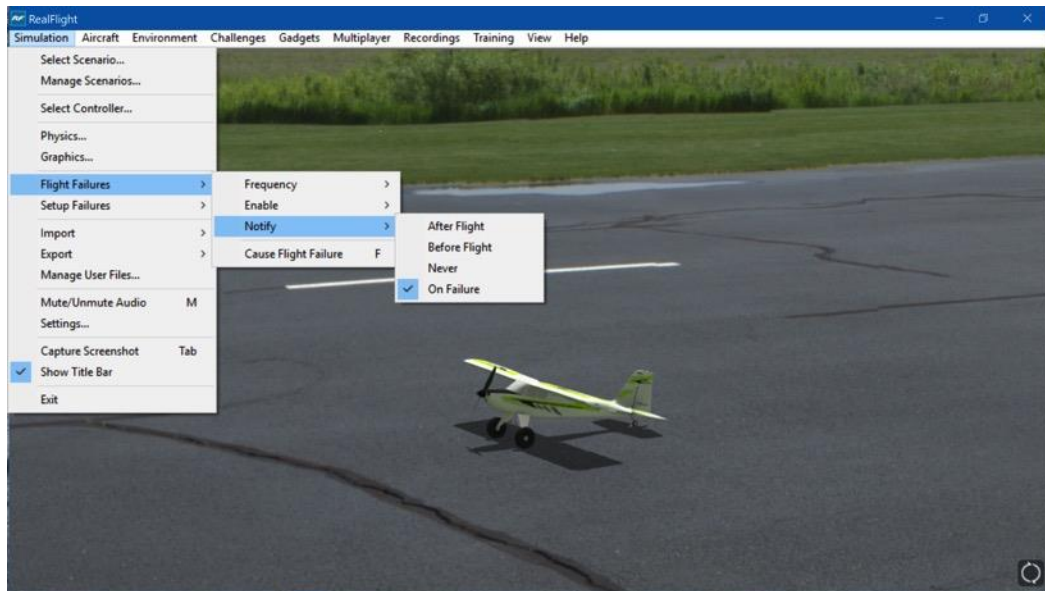

To adjust the settings of this feature, click on the value as indicated in the column to the right of the Notify indicator. Your options are:

- After Flight - RealFlight will advise you as to the flight failure experienced upon the completion of the flight.
- Before Flight - RealFlight will inform you which flight failure you are about to experience before the flight begins.
- Never - RealFlight 9 will never advise you as to the flight failure that you have experienced, or are about to experience. A little mystery is a good thing.
- On Failure - RealFlight will inform you of the flight failure just as it occurs.



## Cause Flight Failure-

This feature causes a flight failure to occur on command. To access this menu item, click on the **Simulation** menu, and then click on the **Cause Flight Failure** menu item.

Alternatively, pressing the 'F' key on the keyboard will also initiate a flight failure.

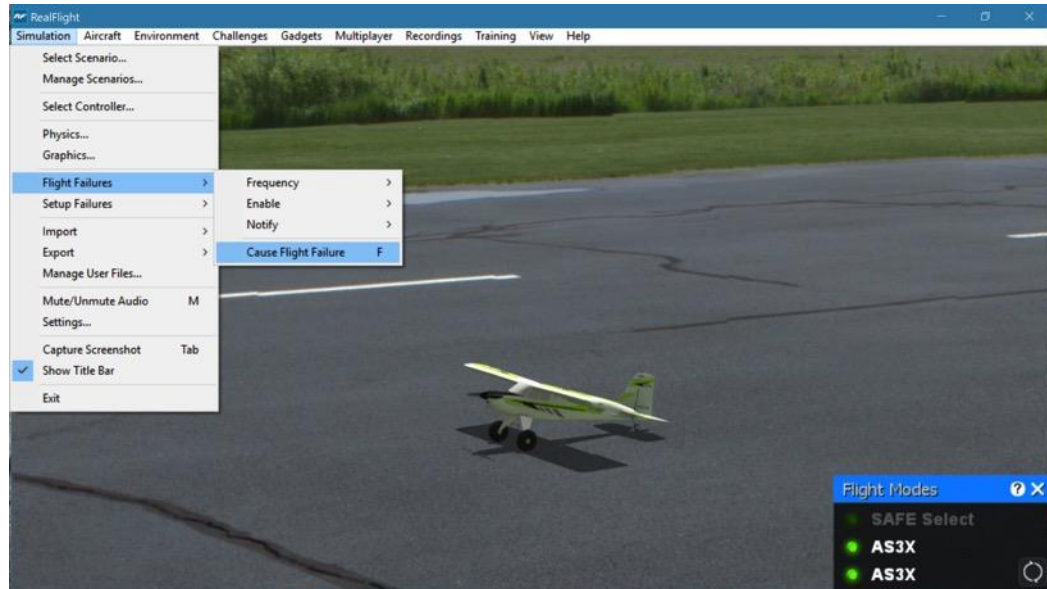

## Setup Failures

Setup Failures are basic difficulties that, generally speaking, should be detected before you ever leave the ground. However, they are often overlooked and occur as a result of a hurried modeler. RealFlight 9 allows you to familiarize yourself with, and determine the types of, setup failures that you will face, as well as how often these failures will occur.

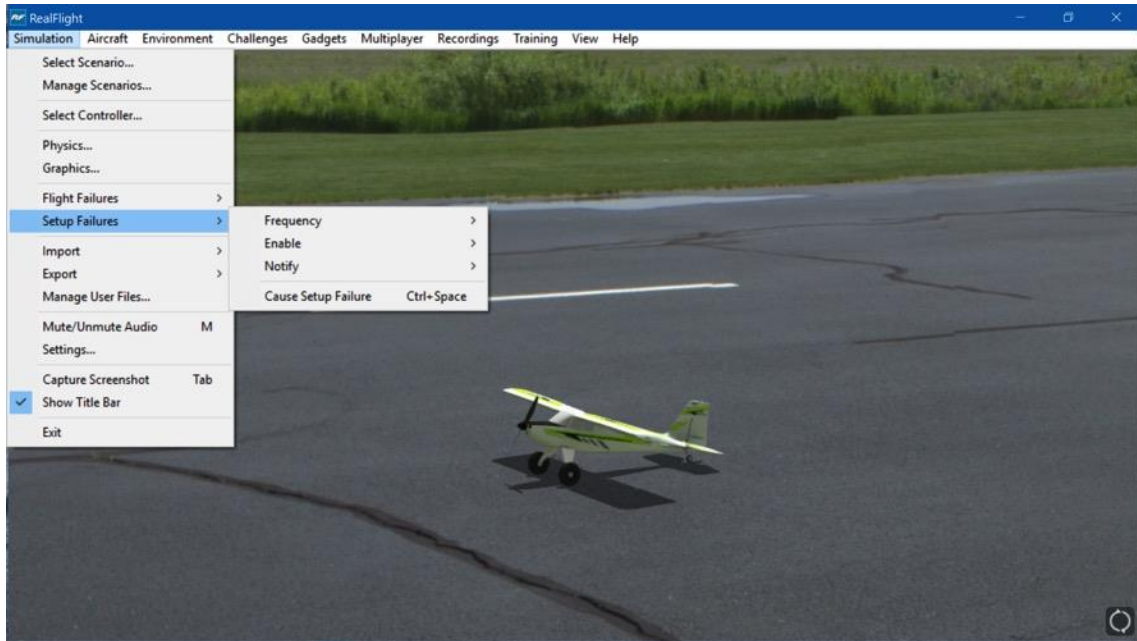

## Adjust the Rate of Occurrence-

To reduce the frequency of flight failures, click on the **Simulation** menu followed by the **Setup Failures** menu item, and then the **Frequency** menu item. This brings up a sub-menu as shown in the screen below. Once the sub-menu is visible, simply mouse click on one of the options in the pull-down menu.

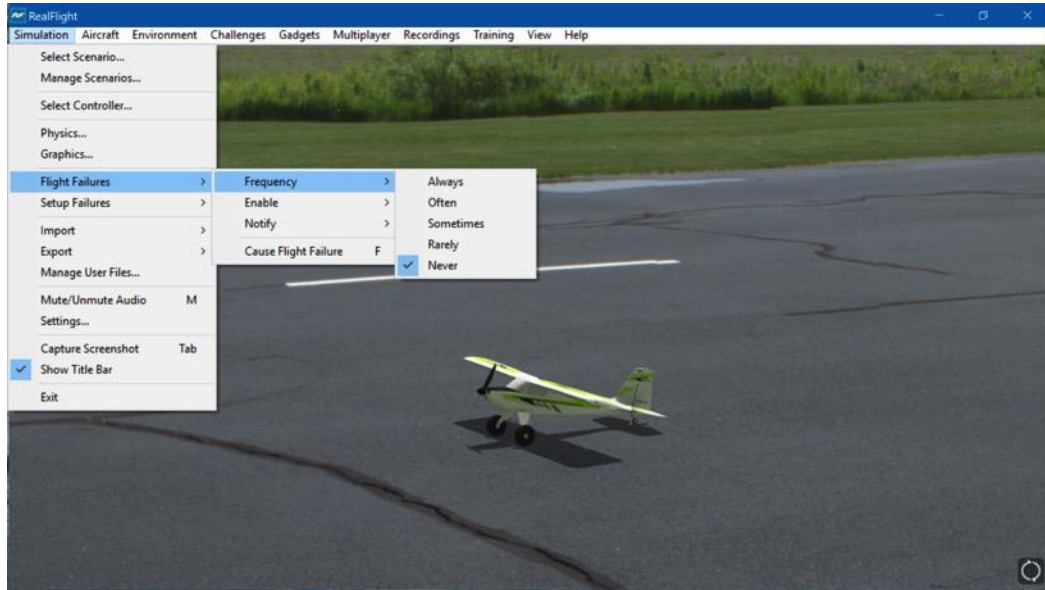

If you do not wish to experience any setup failures, click the **Never** option in the drop-down menu or, if you wish to gain a great deal of experience at handling emergencies, click the **Always** option.

## Selecting the Type of Flight Failures-

RealFlight allows you to determine the type of setup failures that you will experience within the simulation. To do so, click the **Simulation** menu followed by the **Setup Failures** menu item. Next, select **Enable** to bring forth the list of available setup failures. If an item has a check mark next to it, then that failure is enabled. To toggle the flight failure, click on it with the mouse.

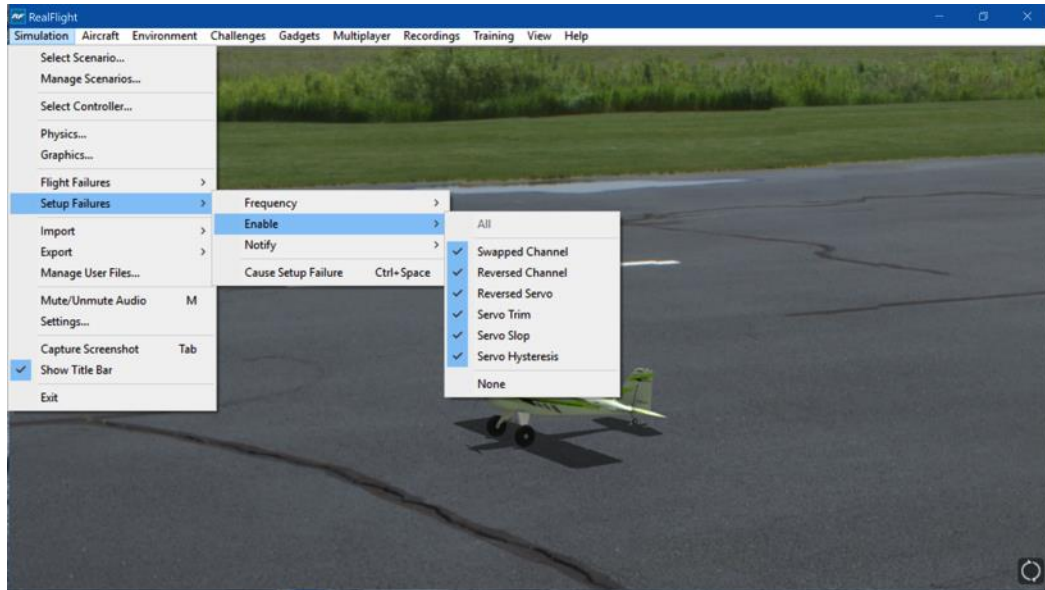

The options for Flight Failures consist of:

- All- Selecting this option will engage all of the setup failures on the list meaning that you could experience all of these possibilities accordingly.
- Swapped Channel - This failure simulates the effect of inadvertently swapping two channels. For example, you may find that your rudder controls the throttle, and vice versa.
- Reversed Channel - One of the channels, selected at random, will operate in a reversed direction.
- Reversed Servo - The travel direction of one of your servos is reversed.
- Servo Trim - A servo alters the trim settings, modifying the flight control position. For example, the elevator servo trim might be slightly off causing the airplane to ascend or descend when it should be flying level.
- Servo Slop - Servo slop may be the result of improper geometry of the linkages or the looseness of the servo gears.



- Servo Hysteresis - The time or gap between a servo input from the pilot and the movement of the servo on the aircraft.

### Notify -

This setting allows you to determine if, or when, RealFlight notifies you as to the setup failure experienced.

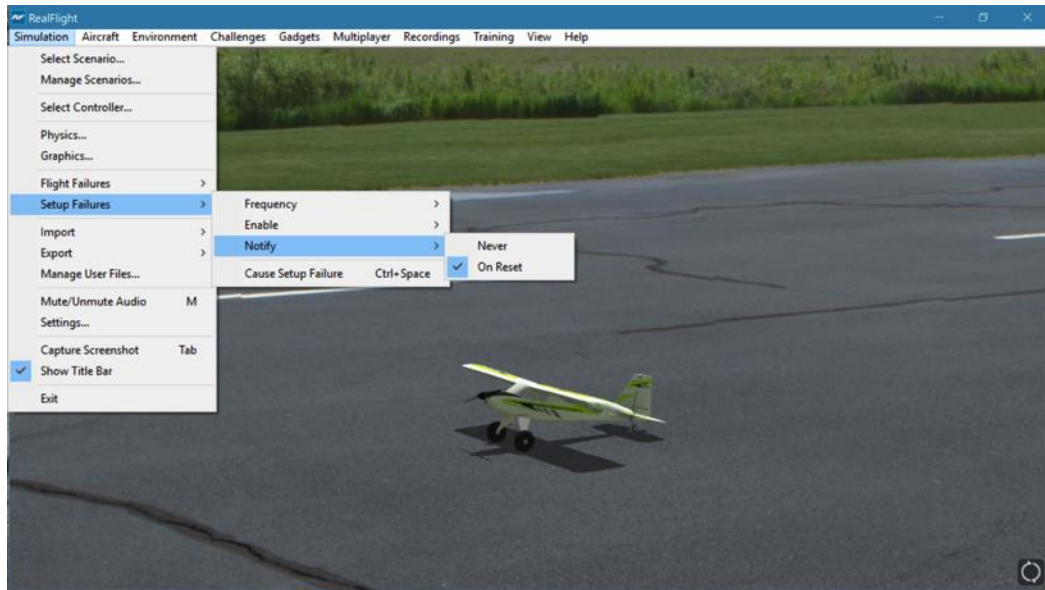

To adjust the settings of this feature, click on the value as indicated in the column to the right of the Notify When indicator. Your options are:

- Never - RealFlight will never advise you as to the flight failure that you have experienced, or are about to experience. A little mystery is a good thing.
- On Reset - RealFlight will inform you of the failure when you reset the flight (hitting the spacebar or Reset button on the controller).

Ctrl

## Cause Setup Failure-

This feature causes a setup failure to occur on command. To access this menu item, click on the **Simulation** menu, and then click on the **Cause Setup Failure** menu item.

Alternatively, you may also simultaneously press the Control and Spacebar keys accordingly.

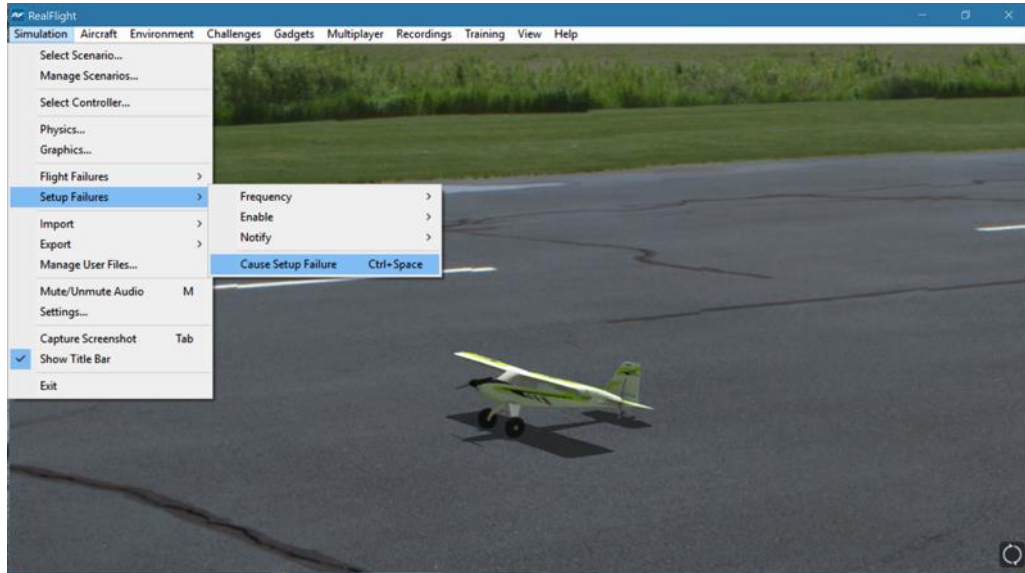

# Import

The Import menu item allows you to import content created by other users. There are several types of files that are associated with RealFlight. Each of these file types will be covered in the section that follows.

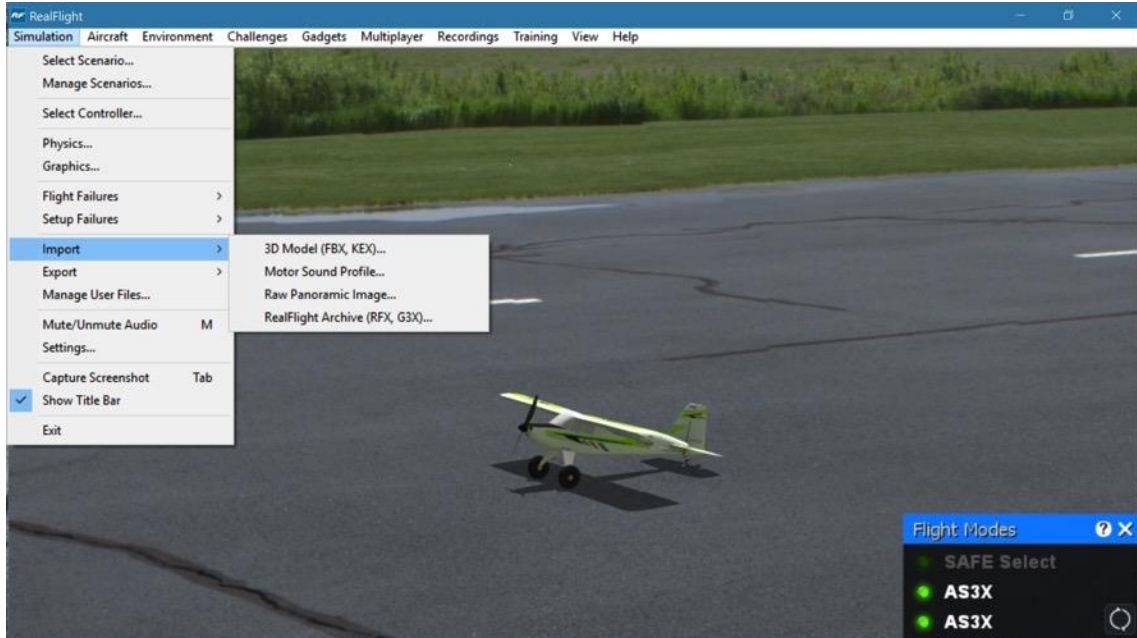

## KEX-

Knife Edge Software has created a plug-in, or software module, that functions with popular 3D modeling tools to create subject matter for the RealFlight software.

The KEX importer is used to bring the model from the plug-in into the simulation itself.

For more information, see: [www.knifeedge.com/KEmax/](http://www.knifeedge.com/KEmax/)

## Motor Sound Profile-

RealFlight allows you to import your own unique sounds for motors that might not already exist in the simulator. By recording the sound of the motor at different RPMs and importing these recordings into RealFlight, the simulator is able to blend these sound files throughout the entire operating range of the motor.

## Raw Panoramic Image-

This file type refers to the panoramic image that helps generate the PhotoField flying sites. This option allows you to create a PhotoField using a panoramic image that you may have downloaded or created yourself. It works best with large images

(8000x4000 or larger) that are equirectangular, spanning 360 degrees horizontal by 180 degrees vertical. Click on the **Raw Panoramic Image...** selection to import an image into the simulation. Browse to the location of the image you would like to import. The image may be in any of the bitmap (.bmp), targa (.tga) or a JPEG (.jpg) file formats.

Once you have located the desired image, double-click the image. Select this image and click **Open**. The conversion process can take several minutes for large images. When the process is complete, RealFlight 9 will automatically create a new PhotoField airport that uses your newly imported image.

To edit the new PhotoField airport (for image alignment, object placement, etc.), access the Airport Editor by clicking the **Environment** menu, followed by the **Create New Airport...** menu item. To see the image from the pilot's perspective, refer to the Pilot Spawn window. Doing so will make it easier to place objects and adjust the image correctly as this will be the location for which most flights will be viewed accordingly. If necessary, adjust the image using the Panoramic Image Y Alignment, Panoramic Image X Alignment and/or the Panoramic Image Facing options located in the Properties window.

### **RealFlight Archive (RFX, G3X)-**

RFX is the file extension that is used for all files exported from RealFlight G4 or later versions. This menu option allows you to import an RFX file. You will use this for all files that you have downloaded. There is nothing special you need to know about the file beforehand; the RFX importer handles all types of content, including: planes, aircraft, color schemes, airports, PhotoFields, and recordings.

This menu item also allows you to import the G3X files that were used in the RealFlight G3 and G3.5 software iterations.

After choosing the Import menu item, followed by the RealFlight Archive (RFX, G3X), you will be presented with an Open file dialog. Use this dialog to find the file that you want to import. Double-click the file or click the file and click **Open**. The import process will start immediately and once it's finished you will see a message confirming its success.

## Export

The Export menu item allows you to share user-created content. It is provided in the Simulation menu as a shortcut to using the Manage User Files dialog.

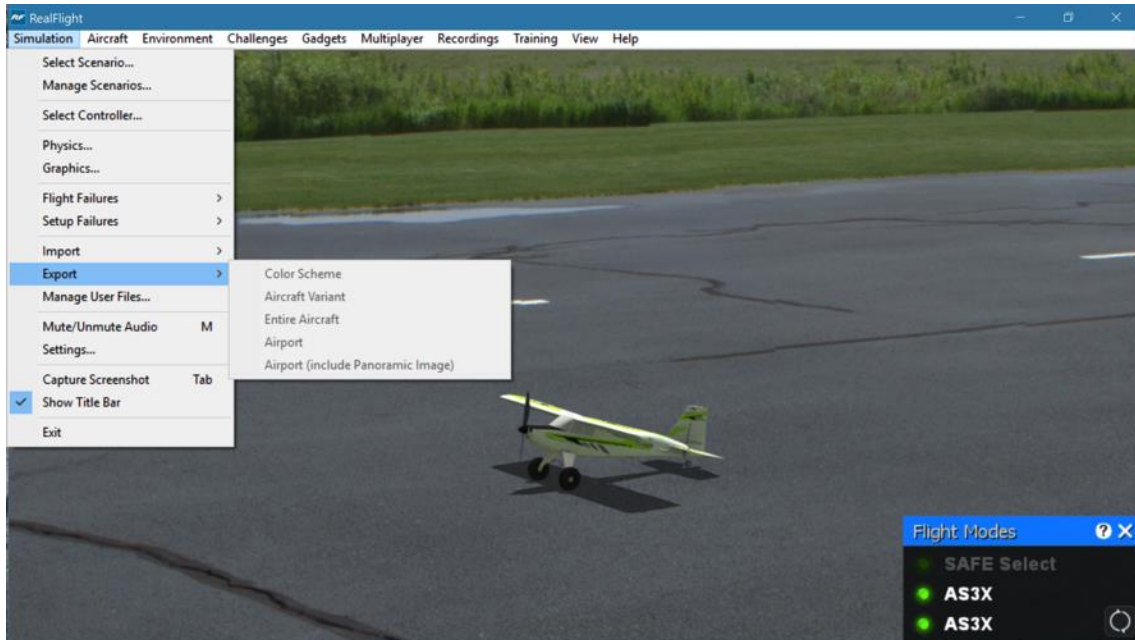

RealFlight users may share the following items: Color Scheme, Aircraft Variant, Entire Aircraft, Airport and Panoramic Images. If one or more of these options on the list is grayed out, it is because the currently loaded color scheme, aircraft, or airport is part of the simulation by default and not available for export. That is, only custom content creations may be exported accordingly.

Once any of these items are exported, you can then share them with friends or the rest of the RealFlight community. The best choice is to upload the files to the RealFlight swap site found at:

<http://swappages.knifeedge.com/>

### Color Scheme-

This option allows you to share the current aircraft color scheme (a.k.a. trim scheme) with other RealFlight users.

To export a Color Scheme, select the **Export** menu item followed by the **Color Scheme** option. A save dialog will appear so that you can choose where you would like to save the exported color scheme and determine the filename. After saving, a message will appear on-screen advising you whether or not the export was

successful. This message will also list the location and name of the file that was exported.

### **Aircraft Variant-**

This option enables you to export an aircraft that has undergone structural modifications such as lengthened wing span, more prop thrust, different airfoils, etc. It is important to note in addition to any wire frame modifications, the Aircraft Variant file option also includes any modifications to the aircraft powerplant, batteries, etc.

To export an aircraft variant, select the **Export** menu item, followed by the **Aircraft Variant** option. A save dialog will appear so that you can choose where you would like to save the exported aircraft variant and determine the filename. A verification message will appear on-screen advising you whether or not the export was successful. This message will also list the location and name of the file that was exported.

### **Entire Aircraft-**

This option enables you to export the entire contents of an aircraft such as trim scheme, structural changes, etc.

To do so, select the **Export** menu item followed by the **Entire Aircraft** option. A save dialog will appear so that you can choose where you would like to save the exported aircraft and determine the filename. A verification message will appear on-screen advising you whether or not the export was successful. This message will also list the location and name of the file that was exported.

### **Airport-**

This option enables you to export a modified airport. Note that any custom panoramic image you may be using with this airport will not be exported. To export an airport with a custom panoramic image, use the “Airport (include Panoramic Image)” option.

To export an airport, select the **Export** menu item followed by the **Airport** option. A save dialog will appear so that you can choose where you would like to save the exported airport and determine the filename. After saving, a verification message will appear on-screen advising you whether or not the export was successful. This message will also list the location and name of the file that was exported.

## Airport (include Panoramic Image)-

This option enables you to export an airport along with its custom panoramic image. To do so, select the **Export** menu item followed by the **Airport (include Panoramic Image)** option. A save dialog will appear which allows you to choose where you want to export the airport and what you want to name the file. A verification message will appear on-screen advising you whether or not the export was successful. This message will also list the location and name of the file that was exported.

## Manage User Files

The Manage User Files menu item allows you to modify the new user content that you have added to the simulation. You will find that the Manage User Files menu item is a handy tool; it maintains all such files in one, easy to find location.

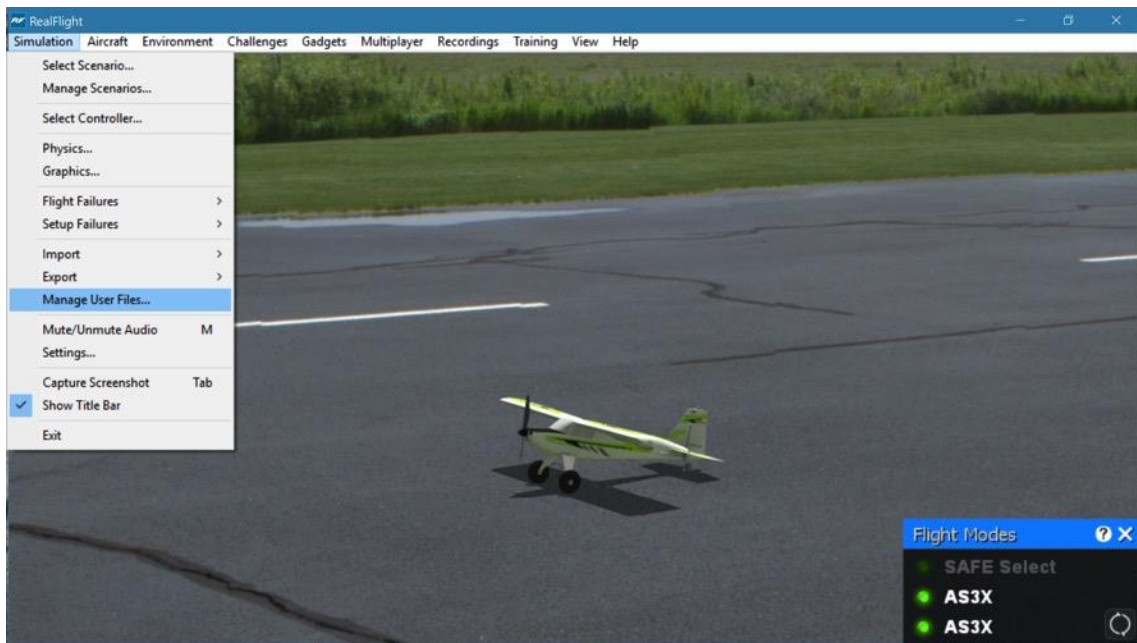

The Manage User Files dialog allows you to copy, rename, delete, or export any custom resource that exists in the simulation. It is important to note that the various Manage User Files buttons will be inactive until a modification to one of the files exists. That is, this menu item is only utilized to modify user-created items. It will not allow you to modify any of the default airports or vehicles included in the RealFlight 9 software.

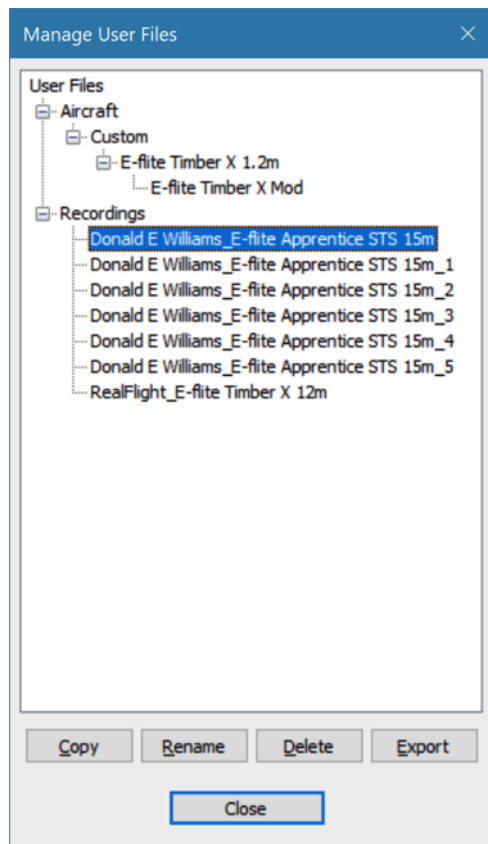

### Copy-

This option duplicates the information and data pertaining to the currently selected item. For example, if you wish to duplicate a flying site located in the User Files, click the **Copy** button. Once you have copied the file, enter a name for the new item.

### Rename-

This option is utilized to rename an existing user-created item.

To do so, highlight the desired item (flying site, etc.) and click **Rename**. Enter the desired name for the item in the dialog provided. The item will now appear in its respective list of offerings with the new name. Please note that this new name replaces the previously existing named item. That is, only the newly named item will appear on the list.



### Delete-

This option is utilized to delete an item entirely. All files associated with the item will be removed from your computer.

It's important to note that users are only allowed to delete items which they, or other users, have created. You cannot delete default items that are included in the software.

To delete a user-created item, select the item in the User File menu and click **Delete**. If you wish to delete this item, click **OK** in the verification dialog. Please note: once deleted, this resource will no longer be available in the simulation.

### Export-

This button is used to export the custom content to a file that can be shared with others. If you have created interesting or unusual content, we encourage you to share your designs with other RealFlight users. The more content that is shared, the more enjoyment everyone will experience.

To export a user-created item, select the respective item in the User File menus and click **Export**. A verification dialog will appear on-screen advising you whether or not the export was successful, and the location and name of the file that was exported. You may then publish the exported file to a web site, move it to another computer, or email it for others to enjoy.



## Mute/Unmute Audio

At times, you may want to fly without any sound. Choose this menu item to mute the audio. Select it again to activate the sounds. Alternatively, pressing the 'M' key on the keyboard will also toggle between the mute/unmute audio selections.

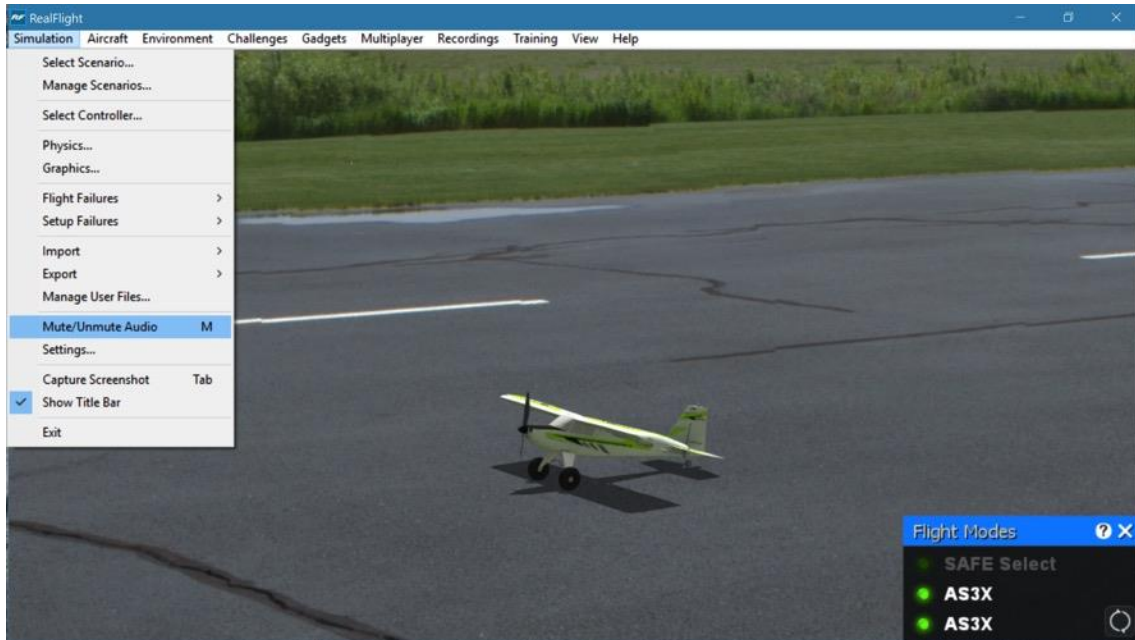

# Settings

The Settings option is an integral part of the RealFlight 9 software. This menu item allows you to adjust a multitude of features and functions within the simulation.

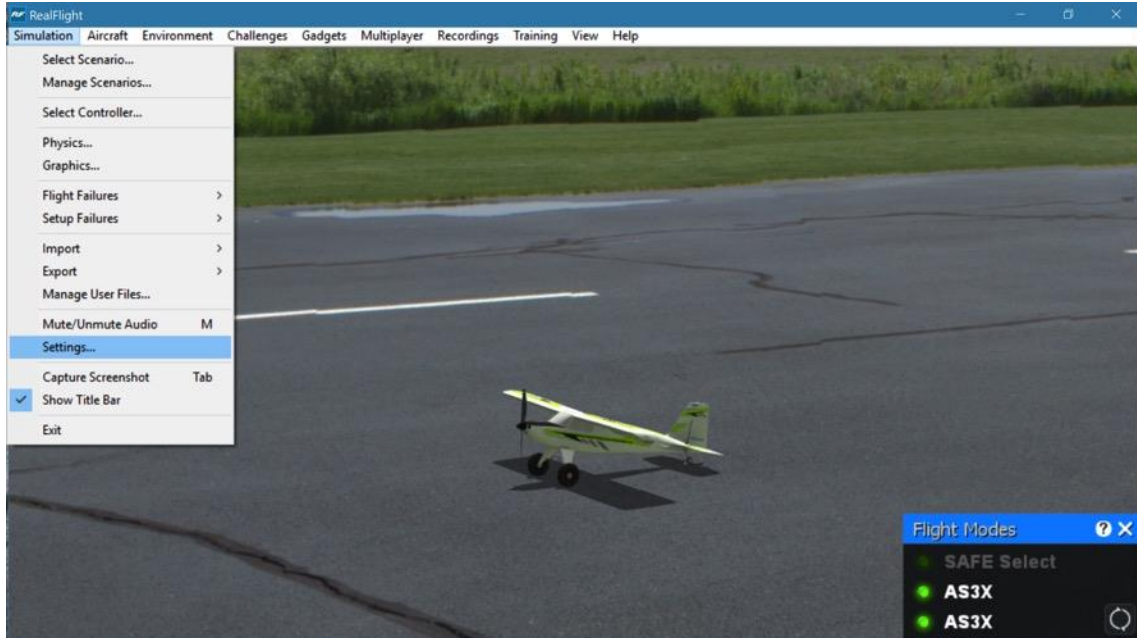

To access this menu item, click on the **Simulation** menu followed by the **Settings...** menu item. The Settings dialog will appear, showing the available options.

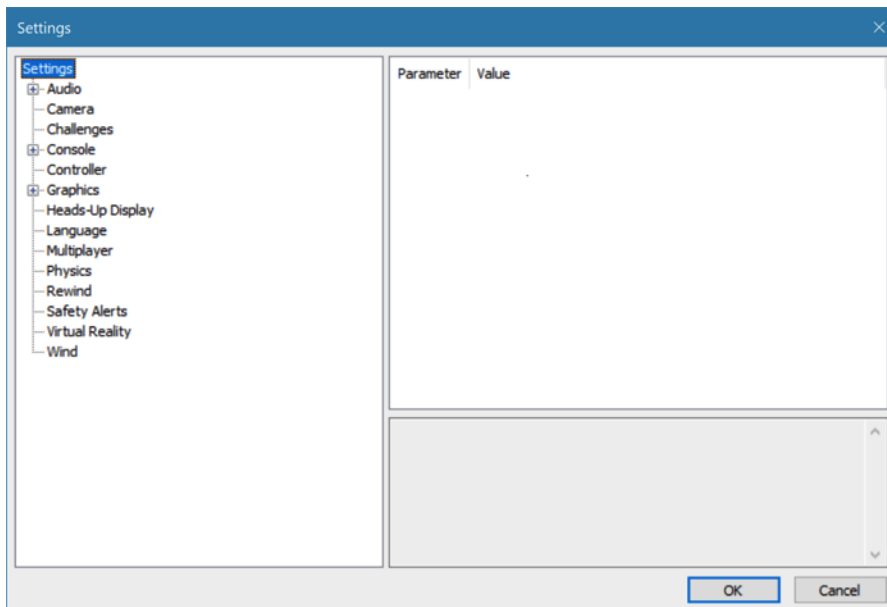

## Audio-

The Audio settings allow you to adjust the volume levels for the aircraft and various options in the simulation. For each type of sound that is adjustable, there are two parameters that can be changed. First is the Volume, which is a percentage of the Overall Volume. The second is whether the sound should be enabled or muted. Double-click on the **Audio** name, or click on the **[+] (plus)** to expand the list and show the Audio options.

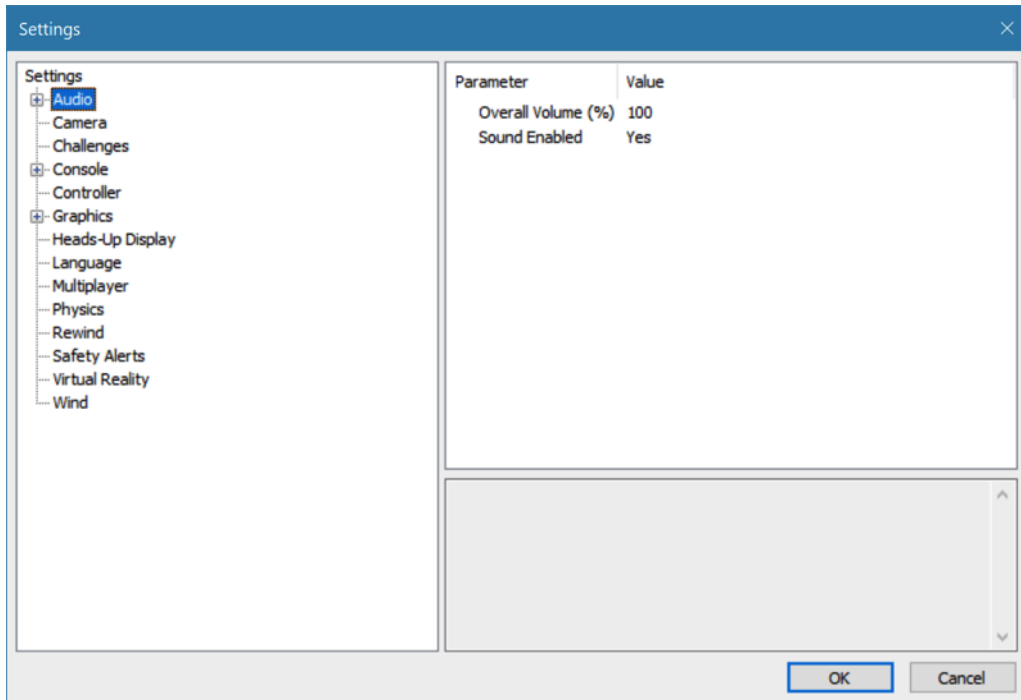

### Overall Volume (%)-

This parameter, found when the Audio setting is selected, controls the volume for all sounds in RealFlight.

### Sound Enabled-

This will mute or unmute all sounds in RealFlight. Alternatively, you may select the **Mute/Unmute Audio** menu item from the Simulation menu, or simply press **M** on the keyboard to toggle this setting on or off.

## Application Sounds-

The Application Sounds section controls the effects and voiceover sounds in the simulation.

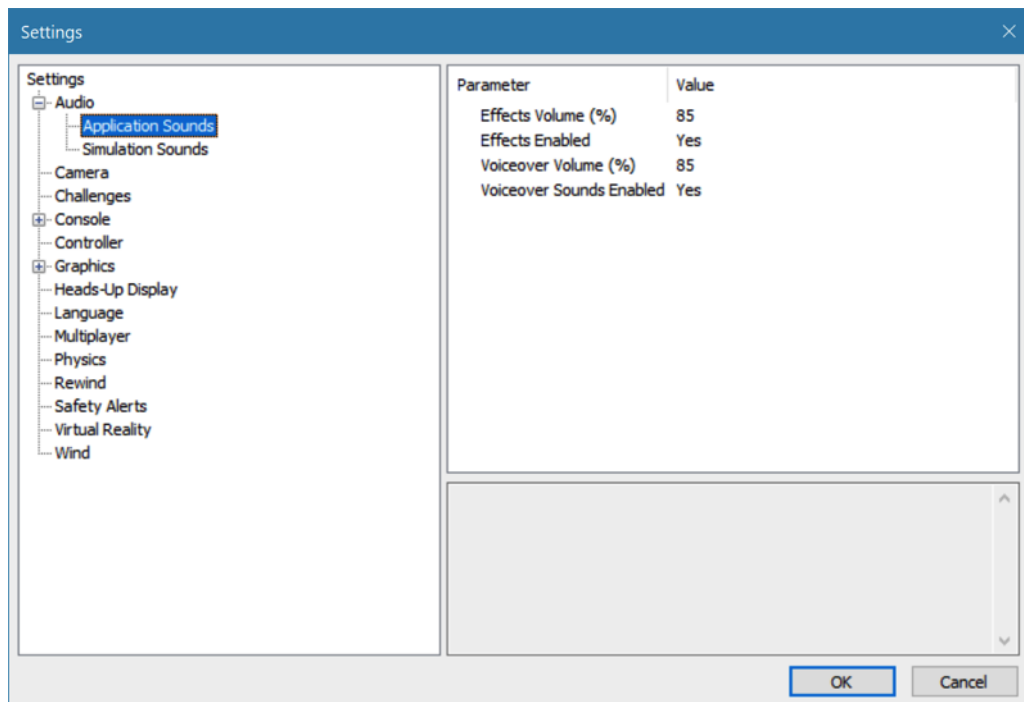

- Effects Volume (%) - This setting adjusts the master volume level for sounds, except all voiceovers.
- Effects Enabled - Choosing No for this option will mute all sounds for the simulator except for the voiceovers.
- Voiceover Volume (%) – This setting adjusts the volume level for the voice chat during multiplayer sessions.
- Voiceover Sounds Enabled - Choosing No for this option will mute all sounds for the voiceovers, etc. in the simulator.

## Simulation Sounds-

The Simulation Sounds section controls the various options related to the miscellaneous sounds in the simulation. RealFlight allows you to make modifications to the various sounds based upon your preferences.

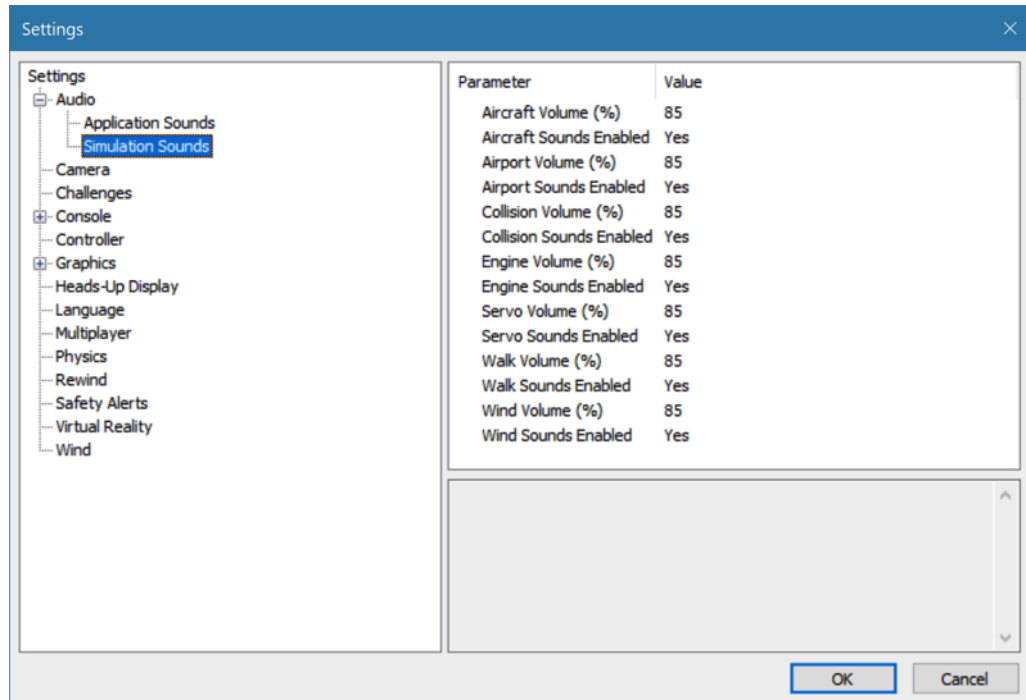

For each type of sound that is adjustable, there are two parameters that can be changed. First is the Volume, which is a percentage of the overall volume. The second is whether the sound should be enabled or muted.

The different sound types are:

- Aircraft – aircraft-related sounds, such as servos.
- Airport – the ambient sounds around the airport.
- Collision – the crashing sounds associated with collisions.
- Engine – the motor and engine sounds.
- Servo – controls the sounds of all the servo motors.
- Walk – the walking sound when moving the camera position.
- Wind – the sound produced by the wind.

## Camera-

The camera options are designed to enhance the field of view when utilizing the Keep Ground in View zoom mode. For additional information on this option, please refer to the View menu chapter of this manual.

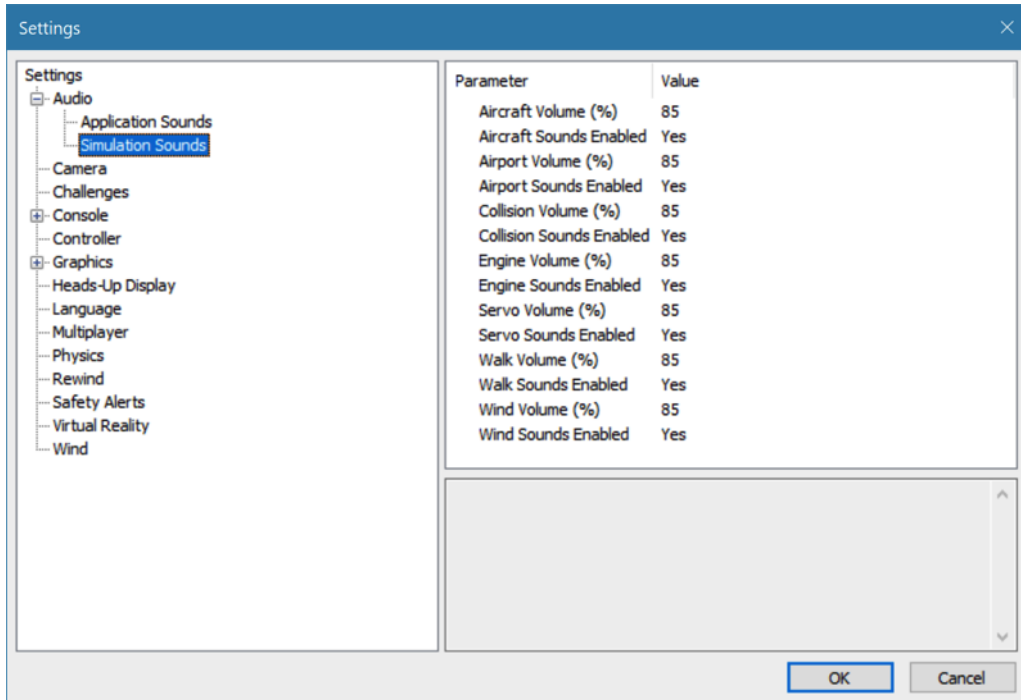

### Minimum Field of View (deg)-

This setting determines the absolute minimum field of view when utilizing the Keep Ground in View zoom option.

To adjust the minimum field of view, click the existing value. Next, enter the desired value either directly from the keyboard or via the mouse wheel.

### Padlock View-

With Padlock View enabled, the cockpit camera position will swivel and follow the targeted aircraft during multiplayer combat events.

### Camera Lag (%)-

This controls how quickly the camera reacts to the aircraft's movements. If the lag is set to zero, the camera always looks directly at the aircraft. At all other values, the camera will have a spring-like reaction to the aircraft during flight.

At very high values, the camera hardly ever looks directly at the aircraft, and often the aircraft will fly off the screen as the camera tries to catch up. At lower values, the

effect is very subtle and yet still softens the camera movement enough so that minor changes in the aircraft's speed/position are more noticeable.

Please note: these settings apply to the "Fixed View" camera mode only. They are not applicable to the cockpit, chase, or onboard views.

### Invert Mouse-

Setting this parameter to **Yes** will invert the vertical, or up/down movement of the mouse when you are in walk mode.

### Chase Camera Distance (ft)-

This parameter allows you to adjust the distance which the Chase Camera will follow the aircraft from behind. Adjusting this value may assist you in Challenges like Balloon Burst.

## Console-

The Console option has a number of sub-categories that allow you to perform modifications to the messages that appear on-screen while running the simulator. It also offers two parameters that affect all of the sub-categories.

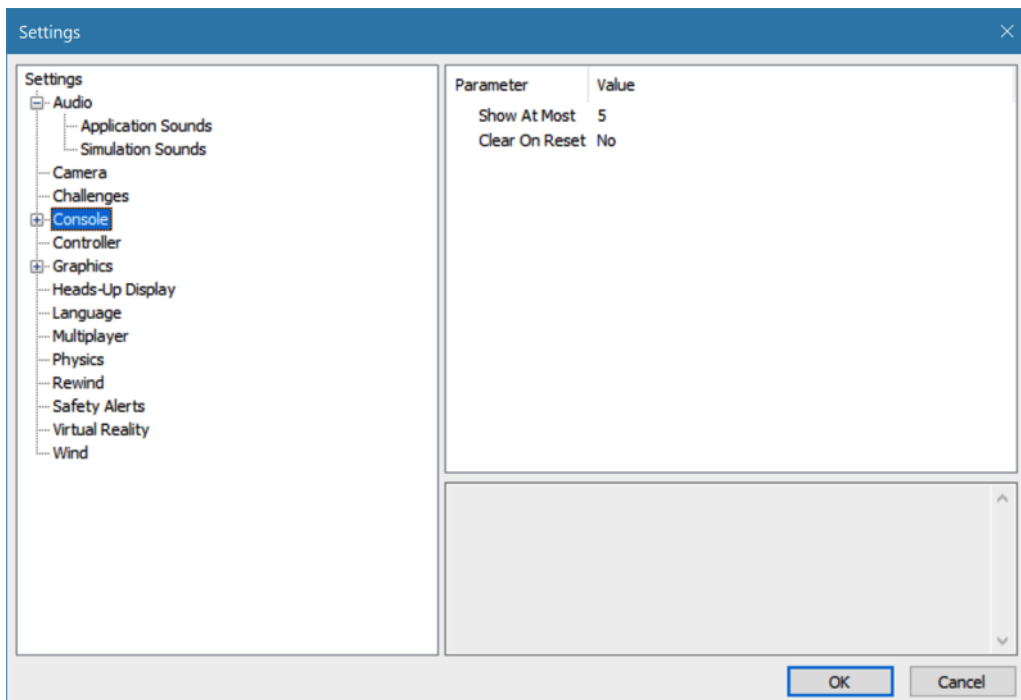

### Show At Most-

This numerical value indicates the maximum number of messages that will appear on your screen at any given time. When the maximum number is surpassed, an older



message will be removed and the most recent message will take its place on-screen. RealFlight defaults to five as the maximum number. Our testing indicates that this number of messages will not detract users from their flight. It is possible to increase this number to 100, although the screen becomes very busy.

### Clear on Reset-

This setting controls whether all of the on-screen messages are cleared when the aircraft resets. This prevents the screen from becoming cluttered with messages and information.

Using either the mouse or the up/down arrow keys on the keyboard, select **Yes** (messages automatically clear) or **No** (messages remain on-screen after a reset) from the pull-down listings. If using the up/down arrow keys, press **Enter** to finalize your selection.

Double-clicking on the **Console** name or clicking on the **[+] (plus)** will bring forth the following options:

- Instructions
- Notifications
- Warnings
- Errors
- Chat Messages (Sent)
- Chat messages (Received)
- Commands

Each of the System Messages screens is independently adjustable and may be tailored to suit your personal preferences. For information on how to do so, please read the following section.

## Instructions-

This option determines the settings for the system Instructions messages. To select the Instructions options, click on the Instructions name.

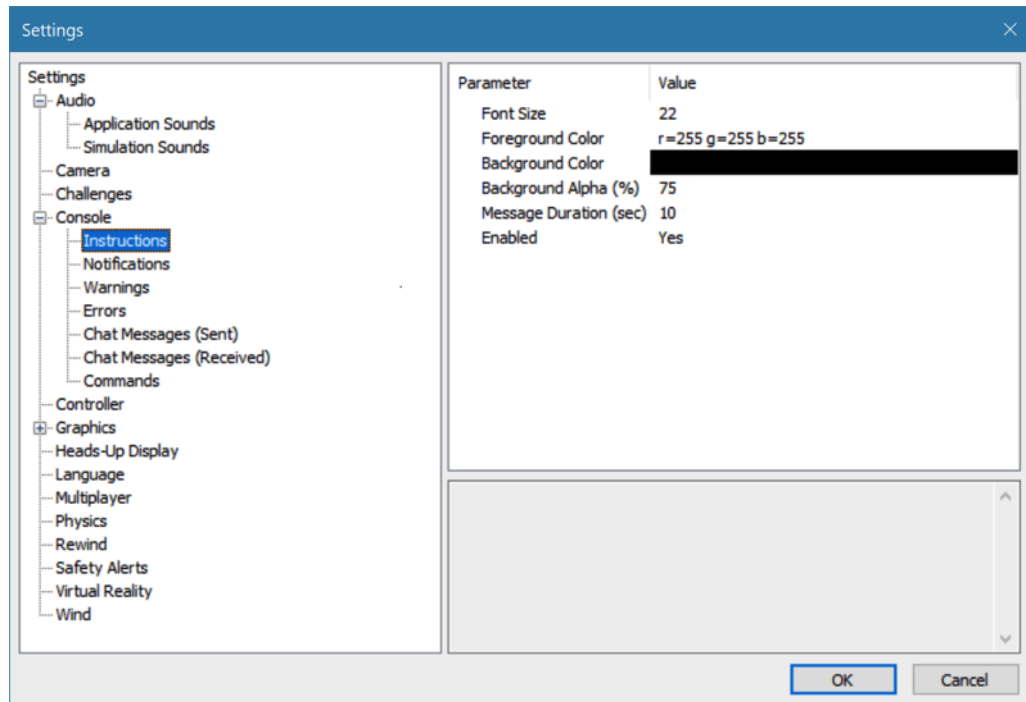

## Font Size-

This option allows you to adjust the font size for the messages pertaining to the instructions. Please note: this only affects the Instructions. It does not affect any other system messages.

To access the Font Size options, click on the value shown in the respective column. The desired values may be input directly from the keyboard or modified using the mouse wheel. The default value of the font size is 22. The simulation allows a minimum font size of 8 and a maximum size of 80.

### Foreground Color-

This option allows the user to adjust the color of the foreground for the Instructions messages.

To access the color palette options for the foreground color, click on the **current value**, then click the **more options** button that appears to the right (the gray button with the ellipsis). This will reveal a screen that appears as follows:



To select a color, click the desired color on the palette. If you wish to make a custom color, click the **Define Custom Colors** button and create the color or colors to suit your tastes. Click **OK** to finalize the selection. The selected color will be reflected immediately in the value column.

### Background Color-

This setting allows you to adjust the color of the background for the Instructions messages.

To access the options pertaining to the background color, click on the **current displayed color**.

To access the color palette for the background color, click on the **current displayed color**, then click the **more options** button that appears to the right (the gray button with the ellipsis). To select a color, click the **desired color** on

the palette. If you wish to make a custom color, click the **Define Custom Colors** button and create the color or colors to suit your tastes. Click **OK** to finalize the selection. The selected color will be reflected immediately in the value column.

#### **Background Alpha (%)**-

This option adjusts the transparency of the text background for the message.

The desired values may be input directly from the keyboard or modified using the mouse wheel. The higher the value, the more transparent the text background will become.

#### **Message Duration (sec)**-

This option adjusts the length of time that a message remains on-screen before it disappears.

You may input desired values directly from the keyboard or modify them using the mouse wheel. The higher the value, the longer the message remains on-screen. The default setting is 10 seconds, however, the value may be refined to allow the message to disappear immediately after it is displayed. Additionally, the setting may be adjusted to 600 seconds (10 minutes), if so desired.

#### **Enabled**-

This option determines whether Instructions messages are displayed or not.

To determine whether this is enabled, click on the respective value indicator. Using either the up/down arrow keys on the keyboard, or the mouse, select either **Yes** (Instructions messages are enabled) or **No** (Instructions messages are disabled) from the pull-down listings. If using the up/down arrow keys, press **Enter** to finalize your selection.

## Notifications-

This option determines the settings for the system Notifications messages.

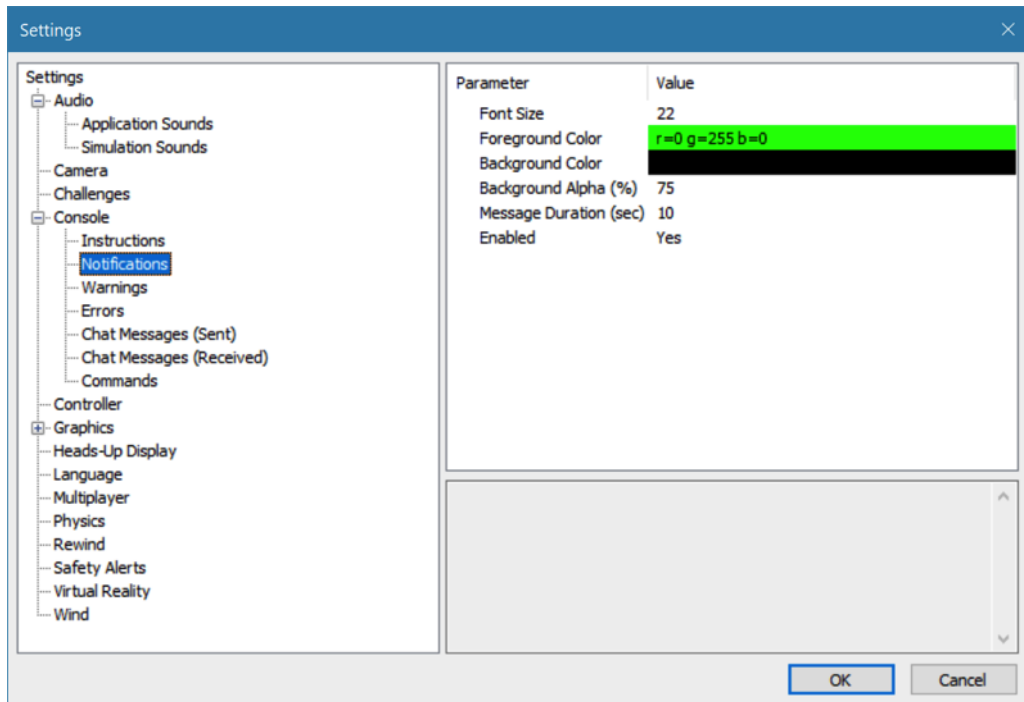

These options function in the same manner as the options for the Instructions messages, except that they only affect the Notification messages.

## Warnings-

This option determines the settings for the system Warning messages.

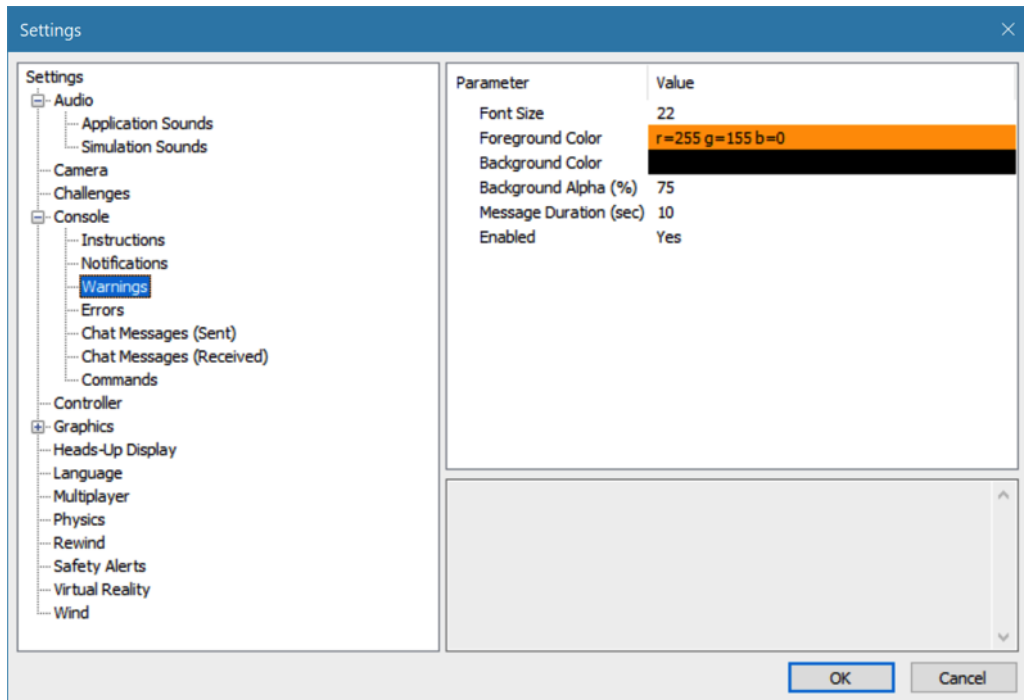

These options function in the same manner as the options for the Instructions messages, except that they only affect Warning messages.

## Errors-

This option allows you to modify the behavior of the system error messages.

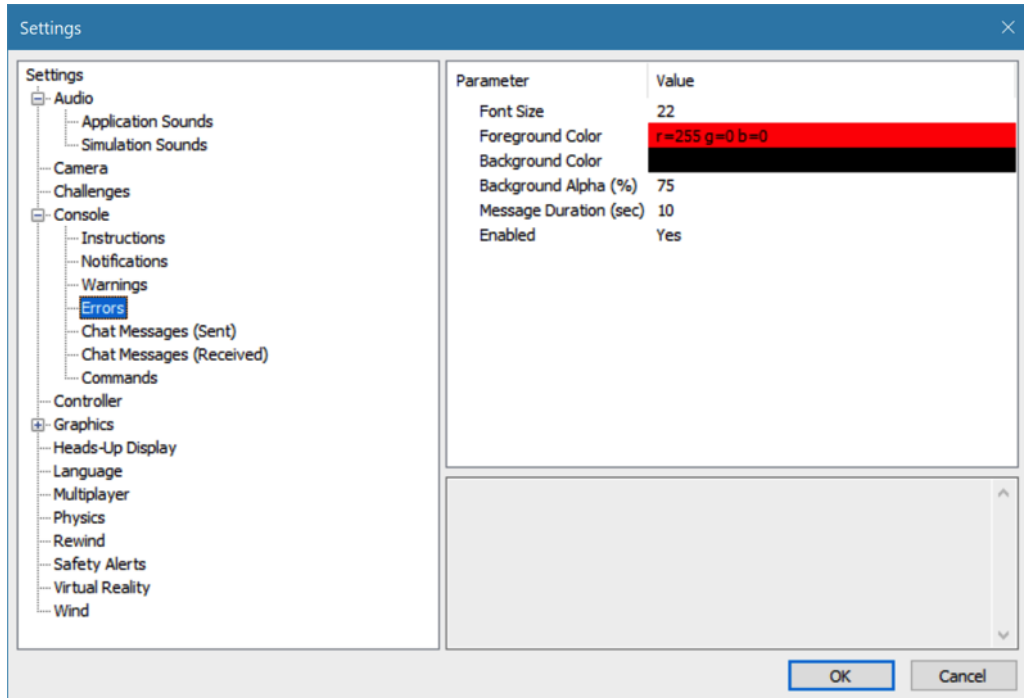

These options function in the same manner as the options for the Instructions messages, except that they only affect Error messages.

## Chat Messages (Sent)-

This option allows you to modify the appearance of text that you type for chat messages during multiplayer sessions.

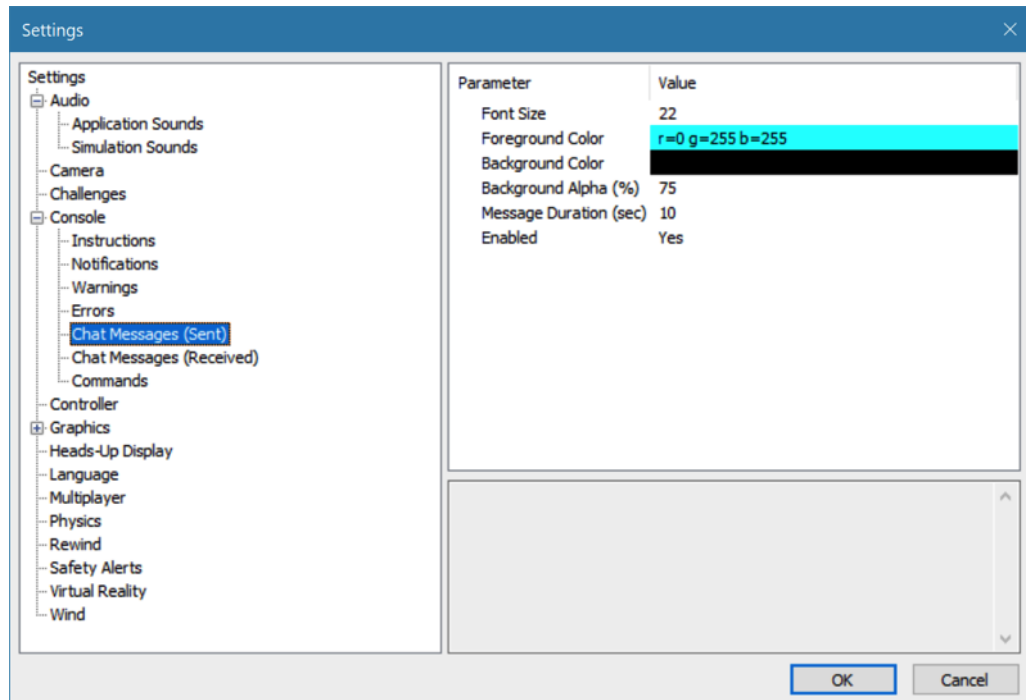

These options function in the same manner as the options for the Instructions messages, except that they only affect Chat Messages (Sent) messages.



## Chat Messages (Received)-

This option allows you to modify the appearance of text you receive from other players during multiplayer sessions.

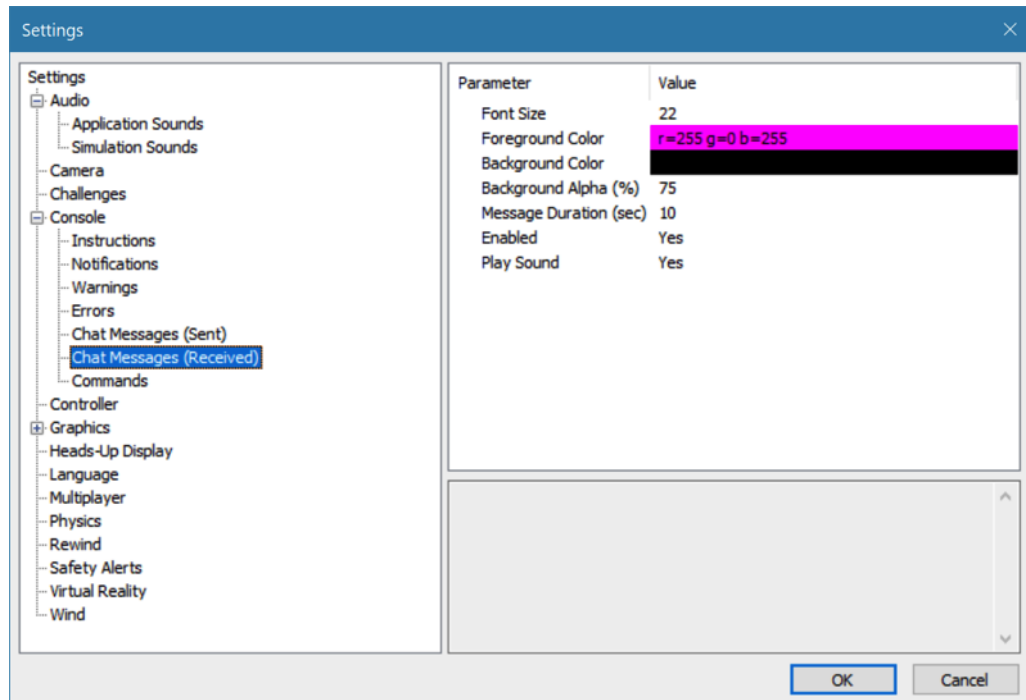

These options function in the same way as the options for the Instructions messages, except that they only affect Chat Messages (Received) messages.

There is one additional parameter available for this option called Play Sound. This allows you to set whether or not a sound is heard when an incoming chat message arrives.

To determine whether this is enabled, click on the respective value indicator. Using either the up/down arrows on the keyboard, or the mouse, select either **Yes** (audio indication is played when a chat message is received), or **No** (no audio indication is played when a chat message is received). If using the up/down arrow keys, press **Enter** to finalize the selection.

## Commands-

This option allows you to modify the appearance of commands typed in the console screen.

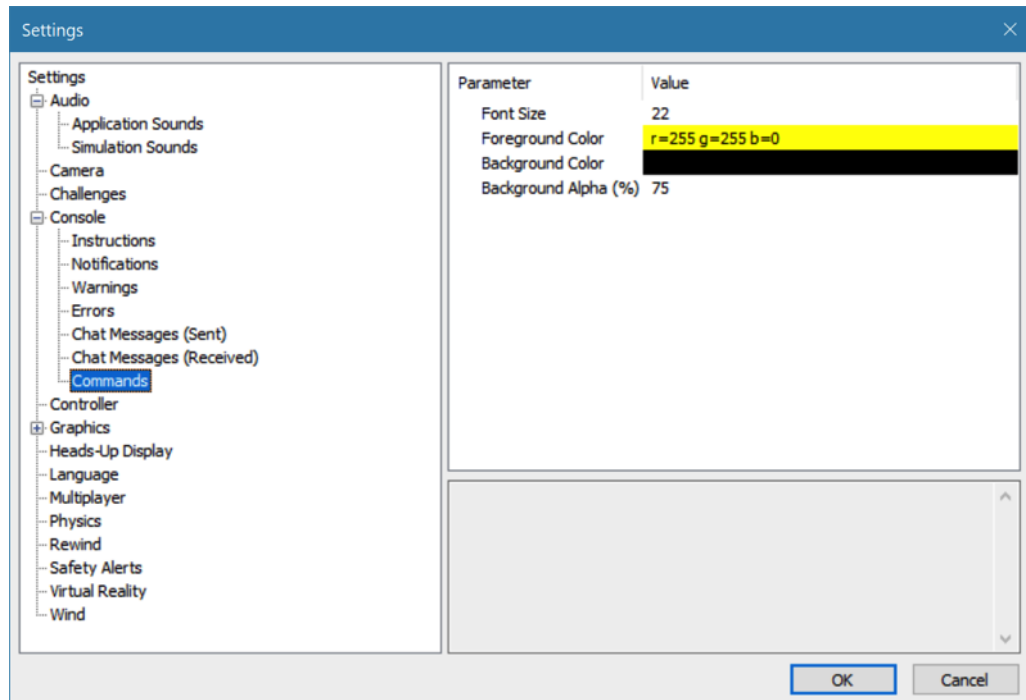

These options function in the same manner as the options for the Instructions messages, except that they only affect Commands messages.

## Controller-

This option allows you to modify/determine the deadband percentage of the controller inputs. This is important and applicable for anyone that is not using a RealFlight controller (InterLink, Spektrum WS2000 Wireless Simulator Dongle, Wired Interface or SLT Wireless Interface).

Pilots using one of the aforementioned control methodologies will most likely want to retain the default value (0).

Allowing refinements to the deadband on the stick inputs is helpful for pilots using a gamepad controller or joystick to pilot RealFlight. We encourage these users to experiment with different percentages until the aircraft responds as desired when a control input is given.

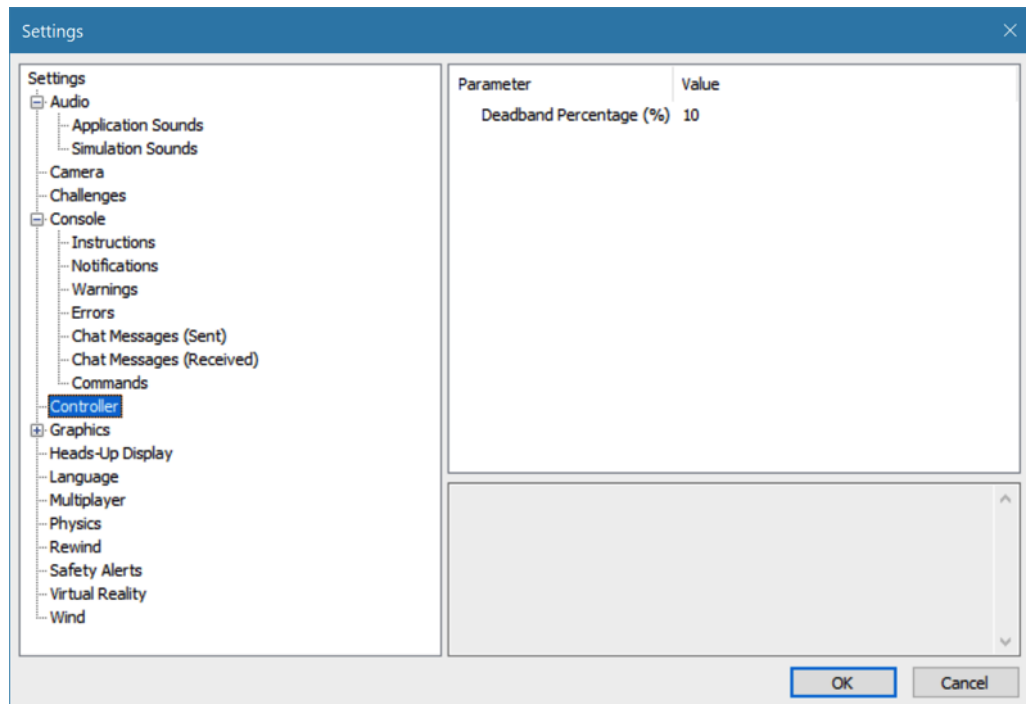

## Graphics-

Double-click on the **Graphics** name or click on the **[+] (plus)** to expand the menu and display the various Graphics options.

### Quality-

The Quality options are quite useful in fine-tuning your simulator, to ensure that it runs as efficiently and realistically as possible on your PC. Use the settings in the Graphics options to obtain the perfect blend of optimal visuals and performance from your PC. If you are experiencing slow frame rates or other performance issues, it may be prudent to turn down some graphics quality options.

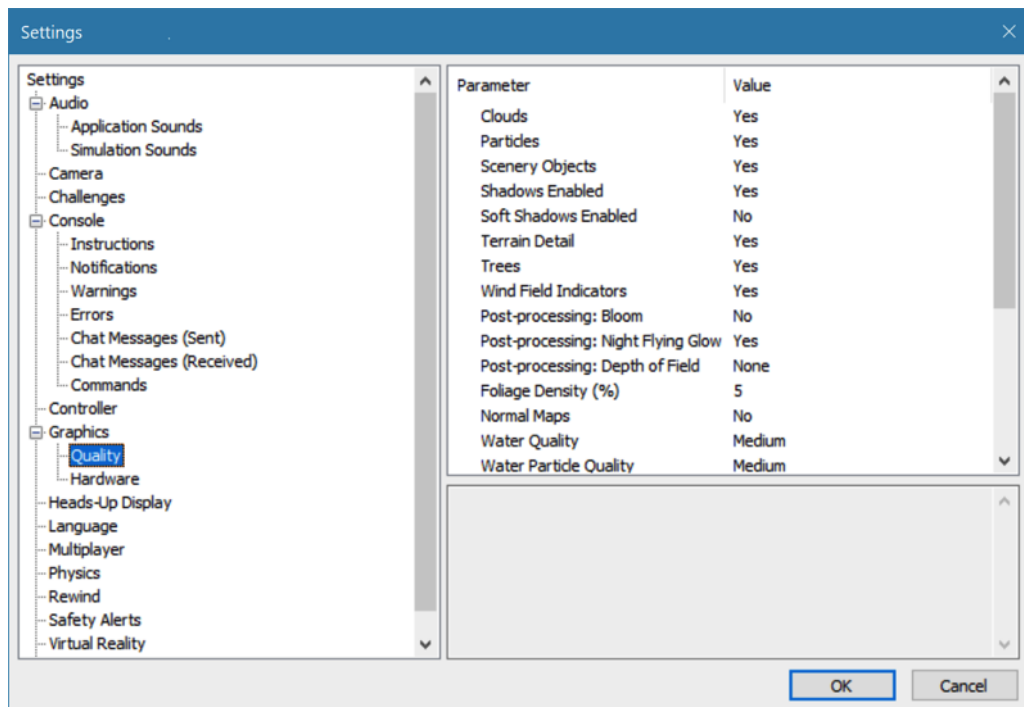

Please note: Many of the adjustments will not take place immediately. In many cases, you will need to restart the simulator in order for the selection(s) to take effect.

### Clouds-

This option determines whether your flying sites will include clouds in the skyline.

Click on the respective value indicator. From the pull-down options select either **Yes** (clouds will be present) or **No** (clouds will not be present).

Please note: This setting will not affect the presence of clouds in the PhotoField airports.

### Particles-

This option determines whether RealFlight will utilize particles such as engine smoke.

Click on the respective value indicator. From the pull-down options select either **Yes** (RealFlight will display smoke), or **No** (RealFlight will not display smoke).

### Scenery Objects-

This option determines whether the simulation displays background objects such as buildings, rocks, benches, etc. If Yes is selected, the background objects will be present. If No, the background objects will not appear in the simulation.

To change this setting, first click on the respective value indicator. From the pull-down options select either **Yes** or **No**.

Please note: This setting will not affect the presence of scenery objects that are part of the high-resolution digital image in the PhotoField airports.

### Shadows Enabled-

The Shadows option determines whether the simulation displays shadows.

To change the Shadows setting, click the value located to the right of the Shadows name. Next, click **Yes** to display the shadows, or **No** to hide the shadows.

### Soft Shadows Enabled-

This option determines whether or not RealFlight displays softer, more realistic appearing shadows.

Enabling this option offers a more realistic appearance within the simulation but may adversely impact performance. If you notice a poor frame rate while running RealFlight, try turning off this option by selecting **No**.

### Terrain Detail-

This option determines whether or not RealFlight displays the details found in the textures associated with the terrain.

Modify the Terrain Detail setting by clicking on the value located to the right of the Terrain Detail name. Click **Yes** to display the terrain detail texture or **No**, to eliminate the terrain details.

Please note: This setting will not affect the terrain detail in the PhotoField airports.

### **Trees-**

The Trees setting determines whether or not RealFlight will display trees.

To change the Trees setting, click the value located to the right of the Trees. Select **No**, if you do not wish to display the trees in your simulation. If you wish to view the trees during flight, select **Yes**.

Please note: This setting will not affect the presence of trees that are part of the high-resolution digital image in the PhotoField airports.

### **Wind Field Indicators-**

This parameter determines whether or not RealFlight displays the wind field indicators that are present at select airports.

### **Post-processing: Bloom-**

The Bloom effect will cause lighter colors or lights to bleed into neighboring parts, enhancing their perceived brightness.

Please note: Enabling the Post-Processing: Bloom effect may adversely impact performance. If you notice a poor frame rate while running RealFlight, try turning this option to **No**.

### **Post-processing: Night Flying Glow-**

This option affects whether lights for night flying glow, causing the objects to appear brighter.

Please note: Enabling the Post-Processing: Night Flying Glow effect may adversely impact performance. If you notice a poor frame rate while running RealFlight, try turning this option to **No**.

### **Post-processing: Depth of Field-**

This option affects the strength of the depth-of-field effect. A stronger effect will cause out of focus objects to appear more blurry – great for screen shots. Some pilots will prefer to turn this setting lower for actual flight.

The RealFlight 9 program defaults to None, indicating that the objects in the background will not be as blurry. We suggest experimenting with the settings to achieve the desired impact.

### Foliage Density (%)

This setting determines the density and drawing time of the trees and the grass. Lowering the percentage will ensure that the scenery is drawn faster. Again, if you are experiencing low frame rates, lowering this value will speed up the simulation.

To adjust the percentage, click on the value located to the right of the Foliage Density (%) name. Enter the desired input directly from your keyboard, or use the mouse wheel to adjust accordingly.

### Normal Maps

Normal Maps add increased details to aircraft and objects without a large increase in video card processing. Normal Maps are part of the Real Rendering feature in RealFlight.

RealFlight 9 defaults to **No**, however, to ensure that the simulation renders rapidly. If your frame rate is fast, we suggest refining this value to **Yes**, to add increased detail within the simulation.

### Water Quality

This setting specifies the quality of the water in the simulation. To modify the quality of the water, click on the value indicated in the column to the right of the Water name. Select the desired level for your simulation from the pull-down list.

The Highest setting will render the best water, but it requires additional processing power. If your frame rate is low, we suggest reducing the water quality until optimal frame rate is achieved.

### Water Particle Quality

This setting controls the different type of graphical particles related to water. A **Low** setting turns off all water particle effects while a **High** setting will show wakes, splashes, and ripple effects.

### Water Shadow Quality

Turning this setting **On**, will show shadows on the surface of the water as well as on the surface beneath the water for a more realistic appearance. It does increase the demands on the video card though. As such, the setting is defaulted to **Off**.

### Shadow Quality

This setting specifies the quality of the shadows in the simulation as well as how often the shadows are updated. To modify the quality of the shadows,

click on the value indicated in the column to the right of the Shadows name. Select the desired level for your simulation from the pull-down list. The Highest setting will render the best shadows, but it requires additional processing power. If your frame rate is low, we suggest you reduce the shadow quality accordingly.

#### **Shadow Map Quality-**

Shadow Map Quality setting controls the size of the shadow texture. A larger size texture will show more detail for a more realistic appearance. A higher setting improves the look of the shadows as well as the drawing distance for shadows, but requires additional processing power. If your frame rate is low, try reducing the shadow map quality.

#### **Particle Quality-**

This setting adjusts the quality of the smoke, debris and other small objects during the simulation. If the frame rate drops when the smoke is thick, try lowering the particle quality selection until you achieve an acceptable frame rate.

To do so, click on the existing particle quality. Next, from the pull-down menu, select the desired quality level.

#### **Screenshot Quality-**

This setting adjusts the quality of the screenshots. At a low quality, all screenshots are saved as JPG files. If the quality is set to high, screenshots are saved as BMP files.

To change this setting, click on the existing screenshot quality level. Next, from the pull-down menu, select the desired quality level.

#### **Streamer Quality-**

This setting adjusts the quality of the streamers during the simulation. If the frame rate drops when flying an aircraft with streamers, try lowering the quality of the streamers until you achieve an acceptable frame rate.

To do so, click on the existing streamer quality level. Next, from the pull-down menu, select the desired quality level.

#### **Texture Quality-**

Use this setting to add the realistic textures to the items and various other objects found in the simulation.



To do so, click on the existing texture quality level. Next, from the pull-down menu, select the desired quality option. Generally speaking, if the dedicated video memory of your graphics card meets, or exceeds, 128Mb it is possible to increase the quality of the textures to the highest setting.

Please note: You must restart the simulation for the new setting to take effect.

#### **Misc. Graphics Quality-**

This setting adjusts the quality level of miscellaneous items in your simulation.

To alter the Miscellaneous Graphics level, click on the value located to the right of the Misc. Graphics name. Next, select the desired level to utilize for the graphics.

Please note: You must restart the simulation for the new setting to take effect.

## Hardware-

The hardware settings are used to adjust various graphics-related settings to achieve the best possible performance for your PC.

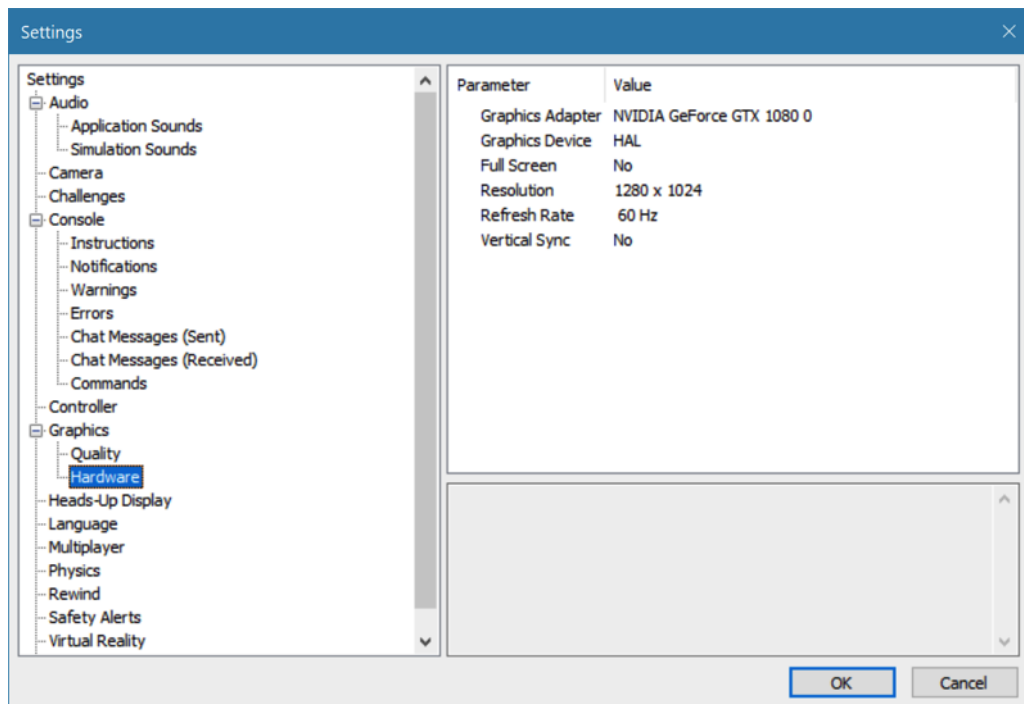

### Graphics Adapter-

The Graphics Adapter is the device that RealFlight utilizes to run the simulation, generically referred to as a video card. Most PC's have only one video card, however, some PC's are equipped with multiple cards.

To determine if your PC has an additional video card available to you, click on the video card information located in the values column to the right of the Graphics Adapter name. If multiple cards appear in the drop-down selection there is another option for you. If not, your PC is equipped with only one video card.

### Graphics Device-

Some video cards offer multiple devices. HAL (Hardware Abstraction Layer) is the preferred device to use for the graphics rendering. In general, you should never need to modify this setting.

To determine if your PC offers alternative devices, click on the value indicated in the column to the right of the Graphics Device name.

### Full Screen-

This option determines whether RealFlight will run using the entire monitor screen for the simulation. If you decide to run in the Full Screen mode, RealFlight's menus will not appear on the screen.

To access the menu while in Full Screen mode, press the **ALT** key on the keyboard.

To adjust the Full Screen option, click on the value as indicated in the column to the right of the Full Screen name. From the pull-down menu, select **Yes** to run in Full Screen or **No**, to run in the Windowed mode.

Alternatively, you may access the Full Screen mode by pressing the **Alt** and **Enter** keys simultaneously on the keyboard. To exit Full Screen mode, press the **ALT** and **Enter** keys simultaneously.

### Resolution-

This control adjusts the screen resolution and color depth when the simulation is operating in full screen mode. This setting does not impact the resolution when running in a windowed mode. If your frame rate is unacceptably low, you can improve it by reducing the resolution or color depth. This will reduce some of the rendering processes required of your video card.

To adjust the resolution for your simulation, click the value indicated in the column to the right of the Resolution name. Select the desired level for your simulation from the drop-down list.

Again, please note: This option is only effective when using RealFlight in the Full Screen mode.

We suggest that you test a variety of resolutions and color options to achieve the optimum performance and setup for your system.

### Refresh Rate-

The refresh rate is the number of times per second that your monitor retraces its video display. Your video hardware (monitor and graphics card) dictates what refresh rates you are able to utilize in the simulation. As with Resolution, this option is only effective when running RealFlight in the Full Screen mode.

To adjust the refresh rate, click the value that is indicated in the column to the right of the Refresh Rate name. If there are multiple options in this list,

you might opt for a lower value to determine if this improves the frame rate of your simulation.

### Vertical Sync-

Enabling this option can create smoother motion by forcing RealFlight to limit your frame rate to the refresh rate of your computer monitor. Vertical sync may improve performance if you experience excessive ‘tearing’ of screen images or regular ‘stuttering’ or ‘hitching’, especially if your average frames per second (FPS) is above 60.

To adjust the Vertical Sync, click the respective value. Select **Yes** or **No** from the pull-down menu that appears.

### Heads-Up Display-

Heads-Up Display is a useful tool to display a variety of flight data in real time similar to an FPV(First Person Video) system. Depending on the environment, you may wish to change the color of the HUD.

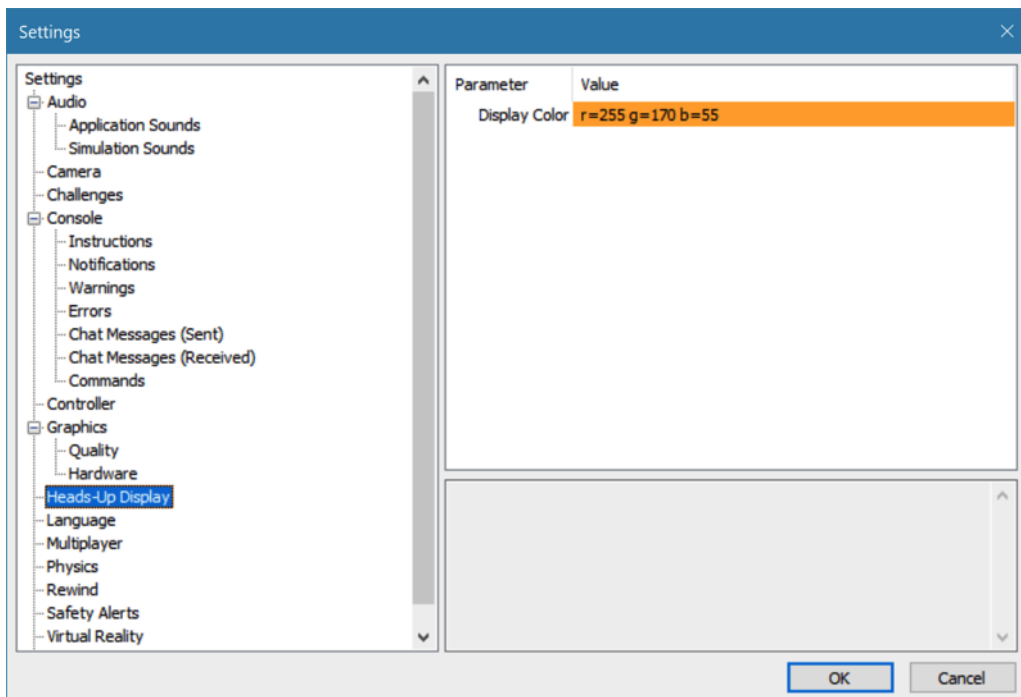

To change the color, click on the **current value**, then click the **more options** button that appears to the right (the gray button with the ellipsis). This will reveal a screen that appears as follows:



To select a color, click the desired color on the palette. If you wish to make a custom color, click the **Define Custom Colors** button and create the color or colors to suit your tastes. Click **OK** to finalize the selection. The selected color will be reflected immediately in the value column.

## Language-

If you wish to adjust the text of the menus, dialogs, etc. to a different language, you can make that change from this setting. Please note: You must restart RealFlight for the change to take effect.

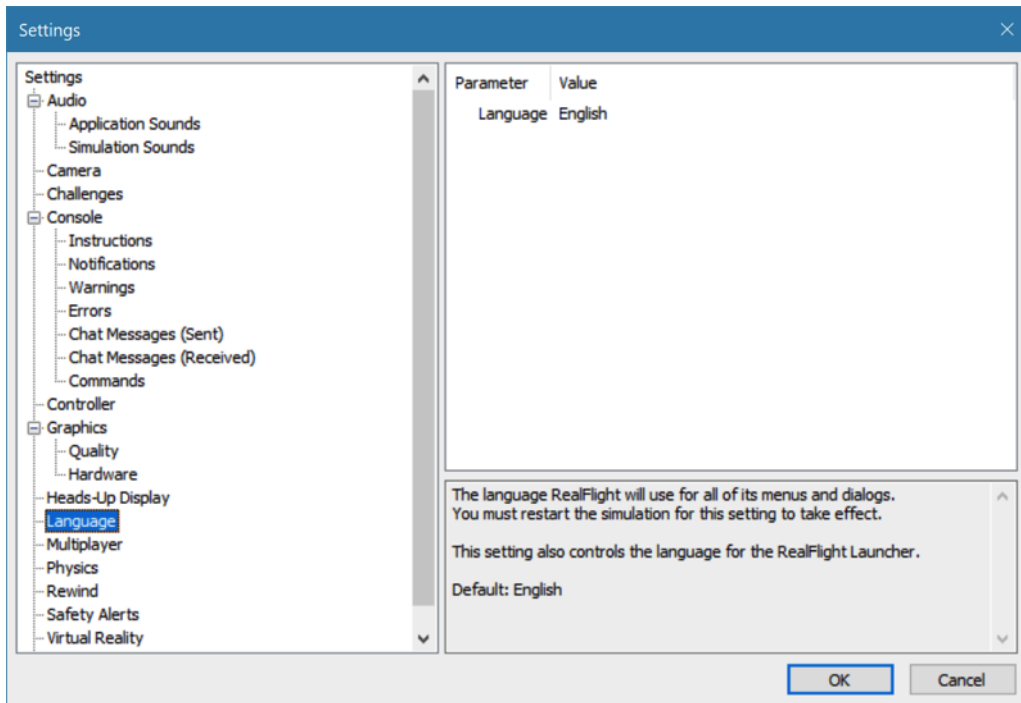

To select an alternate language, click the respective value, select the language preference from the drop-down list that appears.

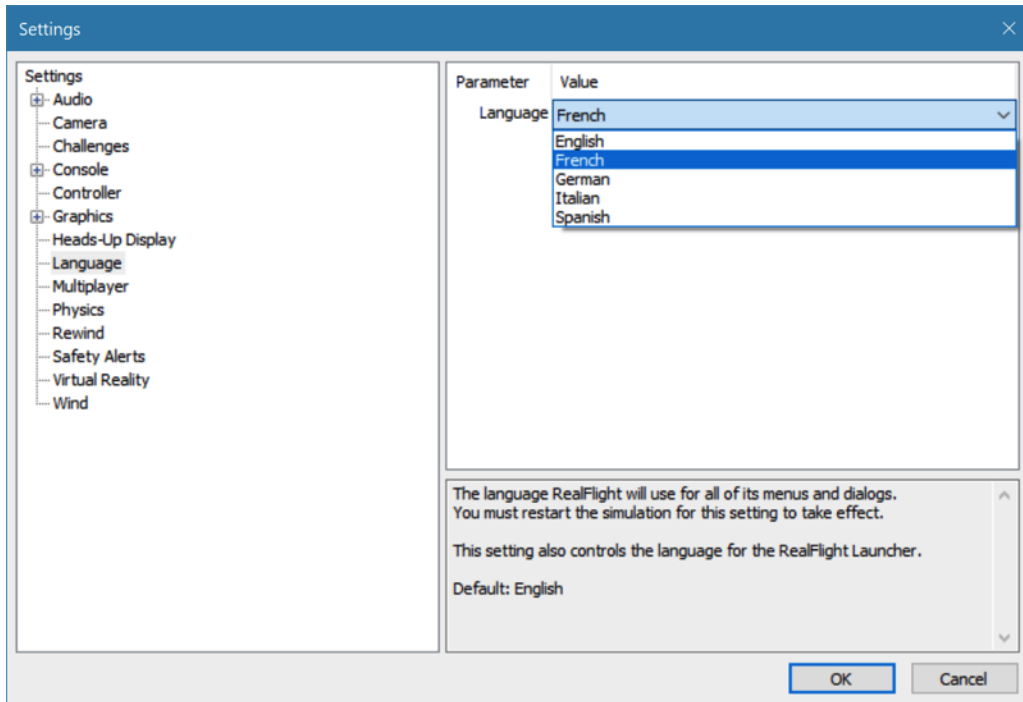

## Multiplayer-

Settings available here affect multiplayer parameters and split screen MultiMode.

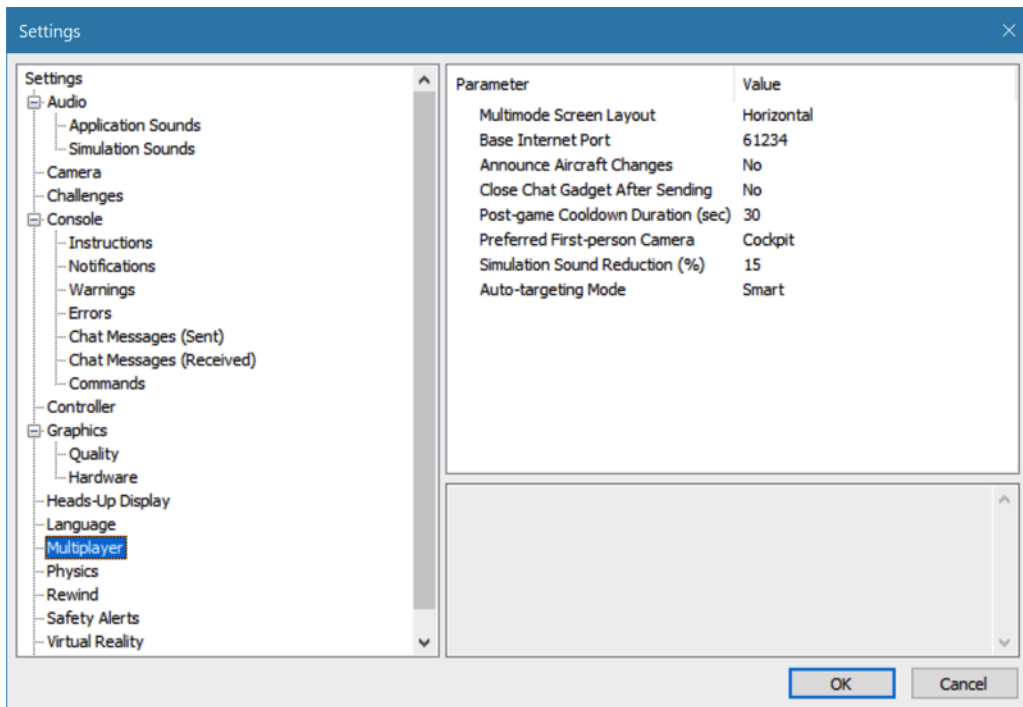



### MultiMode Screen Layout-

This setting specifies the layout of the screen for the MultiMode option. If you select Vertical, the computer screen will split in half on its vertical axis. If you select Horizontal, the computer screen will split in half on the horizontal axis.

To select which mode best suits your tastes, click on the value displayed to the right of the MultiMode Screen Layout column. Next, select either **Horizontal** or **Vertical** from the pull-down options.

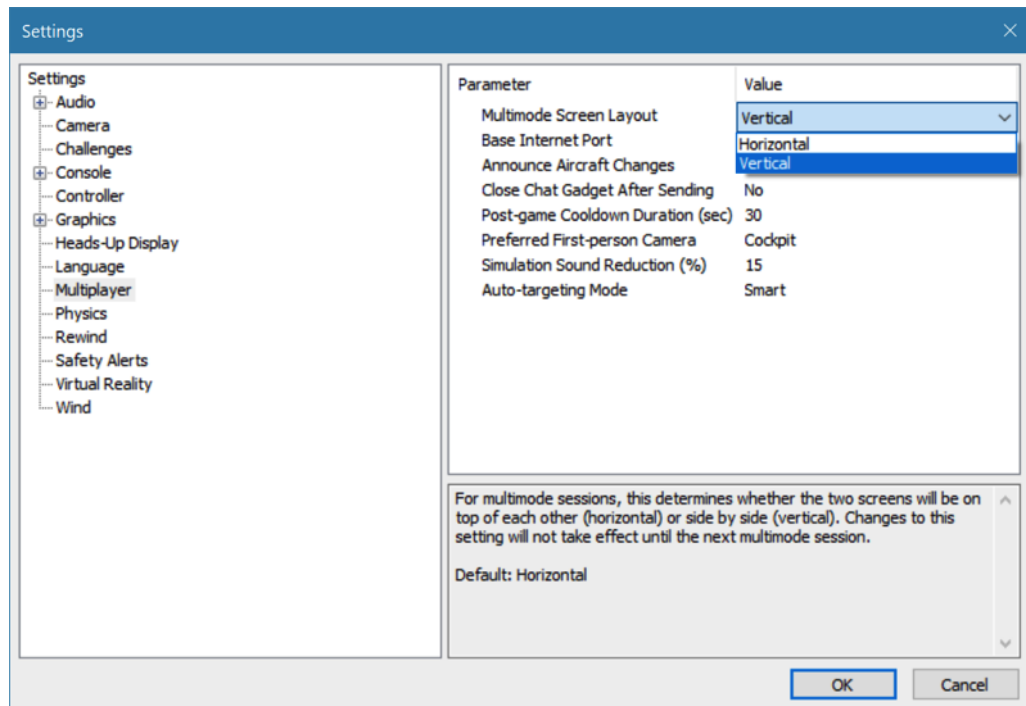

### Base Internet Port-

To access multiplayer sessions with other pilots over the internet, RealFlight utilizes eight ports on your internet connection. By default, RealFlight is set up to use 61234 to 61241. You can change this range by setting the base port numeric value RealFlight will use the next seven ports.

Please note, if you connect to the internet through a network router and/or firewall, you may need to open these ports in order for RealFlight to connect to multiplayer sessions. Check the user manual for your router for information on how to do so.

### **Announce Aircraft Changes-**

During multiplayer sessions, RealFlight 9 can update you with a short message whenever another pilot switches aircraft. To view these messages, set the **Announce Aircraft Changes** to **Yes**. Otherwise, to disable this message, set this parameter to **No**.

### **Close Chat Gadget After Sending-**

The Chat Gadget allows you to send messages in multiplayer sessions using the keyboard. By default, this gadget remains visible when it's enabled. If you wish for the Chat Gadget to close after you send a message, set this parameter to **Yes**.

### **Post-game Cooldown Duration (sec)-**

When running through a Game List as the Host of a multiplayer session, you may wish to add a cooldown period between games. This allows players to review the score of the game they just completed and to relax before the next game begins.

If you wish to start the next game immediately, select the respective value and set the value to zero using the keyboard. Conversely, if you'd like a longer period of time to reflect upon the results, etc. increase this number according to your preferences.

### **Preferred First-person Camera-**

Some games allow you to change your viewpoint. Change this parameter to your preferred camera position for use in games. Alternative perspectives offered are: Cockpit, Nose or Tail. Simply select one of these offerings from the drop-down menu when the respective value is selected.

### **Simulation Sound Reduction (%)-**

If voice chat is active during multiplayer sessions, RealFlight will automatically reduce the volume of all other simulator sounds. Change this percentage to adjust how low simulation sounds are relative to the voice chat.

### **Auto-targeting Mode-**

This parameter allows you to set how RealFlight chooses your target during multiplayer events. This takes effect after each reset of the aircraft. The options available:

Disabled – RealFlight does not change the targeted player. This allows you to have full control of the targeting system.

Leader – RealFlight will target the player with the highest score. If this happens to be you, then RealFlight will select a player at random.

Random – RealFlight will randomly select a player to target.

Smart – All players with a higher score than yourself will be selected somewhat randomly. The player with the highest score and the player that most recently damaged you will have a higher chance of getting selected.

Threat – This option will target the last player which caused damage to you.

## Physics-

The physics options are quite useful in fine-tuning the items applicable to the physics of your simulated aircraft.

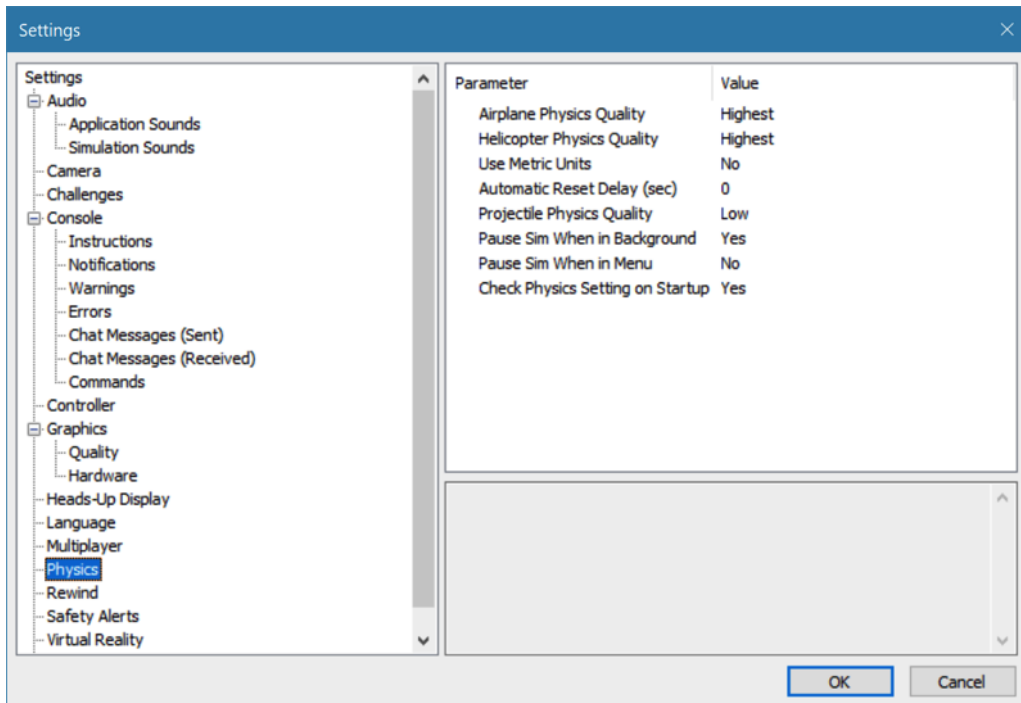

### Airplane Physics Quality-

This setting determines the detail level of physics utilized for the airplanes in the simulation. When the physics level is adjusted to the highest setting, the simulation performs the aircraft calculations more accurately and more frequently. Unless you are running the simulation on an older, slower PC, we suggest using either the 'high' or 'highest' settings. Lowering the physics level will reduce the quality and detail level used in the simulation, thereby allowing the simulation to run at a faster rate on slower PC's.

To alter the physics options, click on the value indicated in the column to the right of the Airplane Physics Quality name. Using either the up/down arrow keys on the keyboard, or the mouse, select the level for your simulation from the pull-down list. If using the up/down arrow keys, press **Enter** to finalize your selection.

### Helicopter Physics Quality-

This setting determines the detail level of physics utilized for the helicopters in the simulation. When the physics level is adjusted to the highest setting, the simulation performs the aircraft calculations more accurately and more frequently. Unless you are running the simulation on an older, slower PC, we suggest using either the 'high' or 'highest' settings. Lowering the physics level will reduce the quality and detail level used in the simulation, thereby allowing the simulation to run at a faster rate on slower PC's.

To lower the physics option, click on the value indicated in the column to the right of the Helicopter Physics Quality name. Using either the up/down arrow keys on the keyboard, or the mouse, select the level for your simulation from the drop-down list. If using the up/down arrow keys, press **Enter** to finalize your selection.

### Use Metric Units-

This option determines the unit of measurement for the various displays found in the simulation. RealFlight defaults to display measurement in SAE units. You can easily change this to use metric units.

To do so, click on the value column to the right of the Use Metric Units name. Using either the up/down arrow keys on the keyboard, or the mouse, select either **Yes** or **No** from the pull-down listings. If using the up/down arrow keys, press **Enter** to finalize your selection.

### Automatic Reset Delay (sec)-

This setting will force RealFlight to automatically reset the aircraft after a crash during which a piece of the aircraft has broken off.

To adjust the Reset Delay, click the respective value. Enter the desired value directly from the keyboard or use the mouse wheel.

### Projectile Physics Quality-

This setting, as the name suggests, is use to determine the physics quality of the rockets, paintballs and guns. With the highest setting, projectiles will collide with terrain, vehicles and all objects at an airport. This is more realistic but requires more processing power. To improve your computer's rendering performance, select a lower setting.

### Pause Sim When in Background-

This setting, when enabled, will pause your flight when you switch away from it. If set to **No**, your flight will continue even when you access other applications. Note that during multiplayer sessions, RealFlight will never pause regardless of this setting.

### Pause Sim When in Menu-

This setting, when enabled, will pause your flight when you access any of the menus. If set to **No**, your flight will continue even when you access the menus. Note that during multiplayer session, RealFlight will never pause regardless of this setting.

### Check Physics Setting on Startup-

The simulation is most accurate when the physics difficulty is set to "Realistic" in the Physics Gadget. If any other setting is selected (including "Custom"), RealFlight shows the Physics Gadget on startup to make it obvious. Disable that behavior by setting this to **No**.

## Rewind -

The rewind section allows you to control the parameters for the Rewind feature. You may disable the Rewind feature altogether, or alter how it functions with the followings settings.

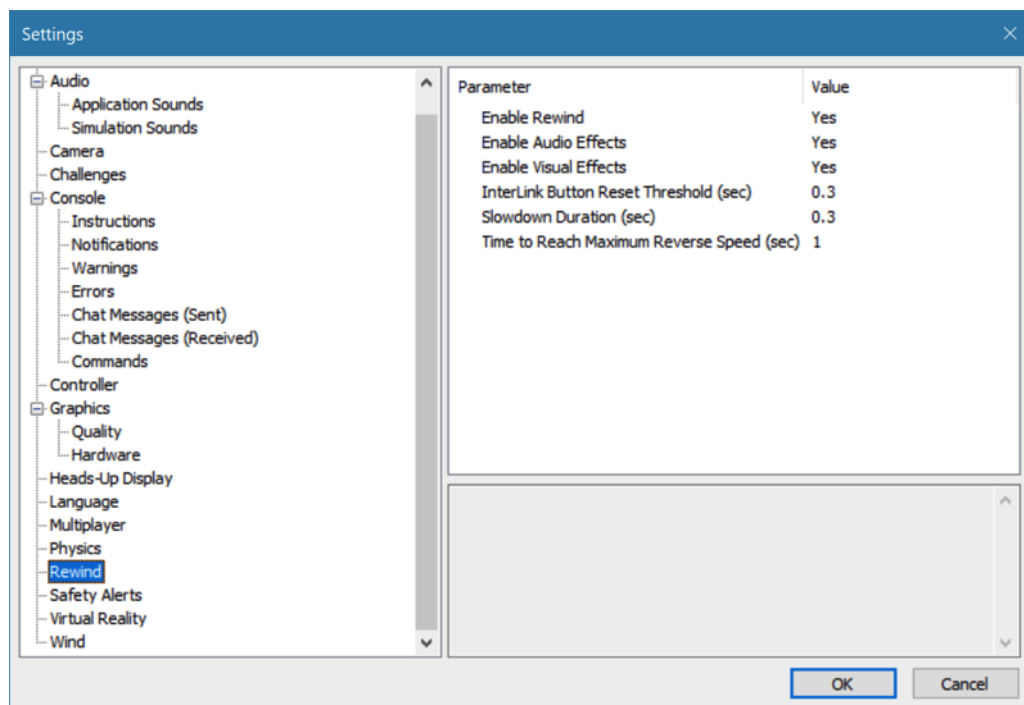

### Enable Rewind-

The Rewind feature is enabled by default. If you wish to turn off this feature, change this setting to **No**.

### Enable Audio Effects-

If you wish to turn off the unique audio effects when activating the Rewind feature, change this setting to **No**. This setting is set to **Yes** by default.

### **Enable Visual Effects-**

If you wish to turn off the video tape graphical effects when activating the Rewind feature, change this setting to **No**. This setting is set to **Yes** by default.

### **InterLink Button Reset Threshold (sec)-**

The Rewind feature is only activated if the Reset button is held down for a specific amount of time. This setting allows you to adjust that threshold. If the Reset button is released before this time limit, the flight is simply reset as normal. The adjustable range is between 0.1- 2.0 seconds with 0.3 as the default setting.

### **Slowdown Duration (sec)-**

Before the Rewind feature kicks in fully, your flight will slow to a stop, then proceed in reverse. The Slowdown Duration setting allows you to adjust how long this process takes. The adjustable range is between 0.1- 2.0 seconds with 0.3 as the default setting.

### **Time to Reach Maximum Reverse Speed (sec)-**

This setting allows you to adjust the amount of time it takes before the Rewind feature is functioning at full speed. The adjustable range is between 0.1 and 10 seconds with 1 second as the default.

## Safety Alerts -

When you are at the flying field, it is important to make sure your transmitter's switches, dials and throttle are all set appropriately before you start your aircraft. The RealFlight 9 program helps to remind you of this important safety practice when resetting your helicopter.

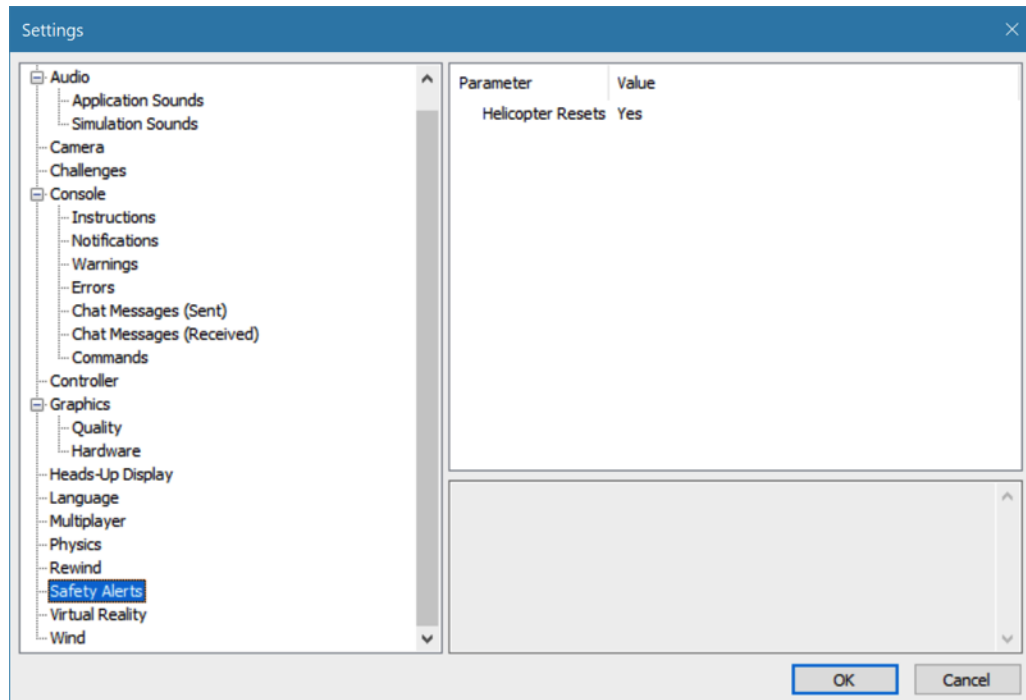

### Helicopter Resets-

When you reset your helicopter, a small window will appear, warning you if the throttle or switches are in a position which could damage the helicopter. For example, you would not want the helicopter to be reset with the throttle stick in the full throttle position as this could prove to be embarrassing at the least or even quite possibly disastrous. To disable this feature, change this setting to **No**.

Alternatively, you can also eliminate this warning screen within the simulation by clicking the box in the 'Do not show this alert again' Safety Alert that appears on-screen.

## Virtual Reality -

RealFlight 9 continues to embrace the use of virtual reality goggles such as the Oculus Rift and HTC's Vive headsets. This setting enables the user to change the size of the user interface (UI) while using the VR within RealFlight.

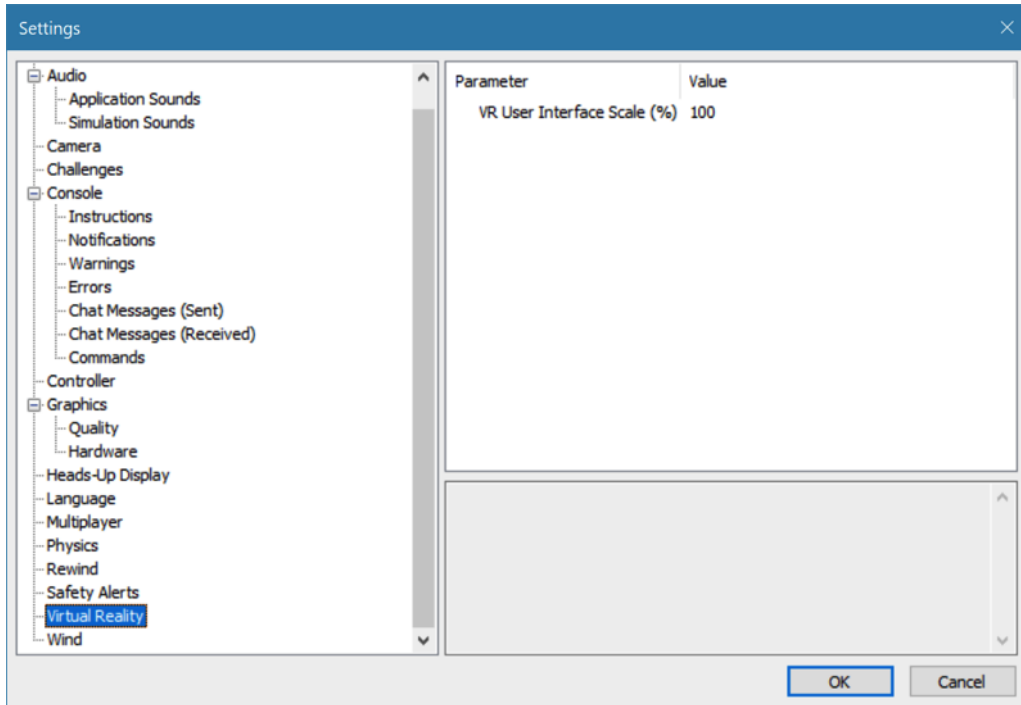

The adjustable percentage range is between 50 and 200%; with 100% being set as the default. If, within VR you determine that this is too large for your personal preference, simply click on the Value and adjust this percentage using the mouse wheel or input directly via the keyboard.



## Wind -

The wind and weather options control the atmospheric conditions encountered in the simulation. You can adjust these to match the conditions typically found at your local flying site.

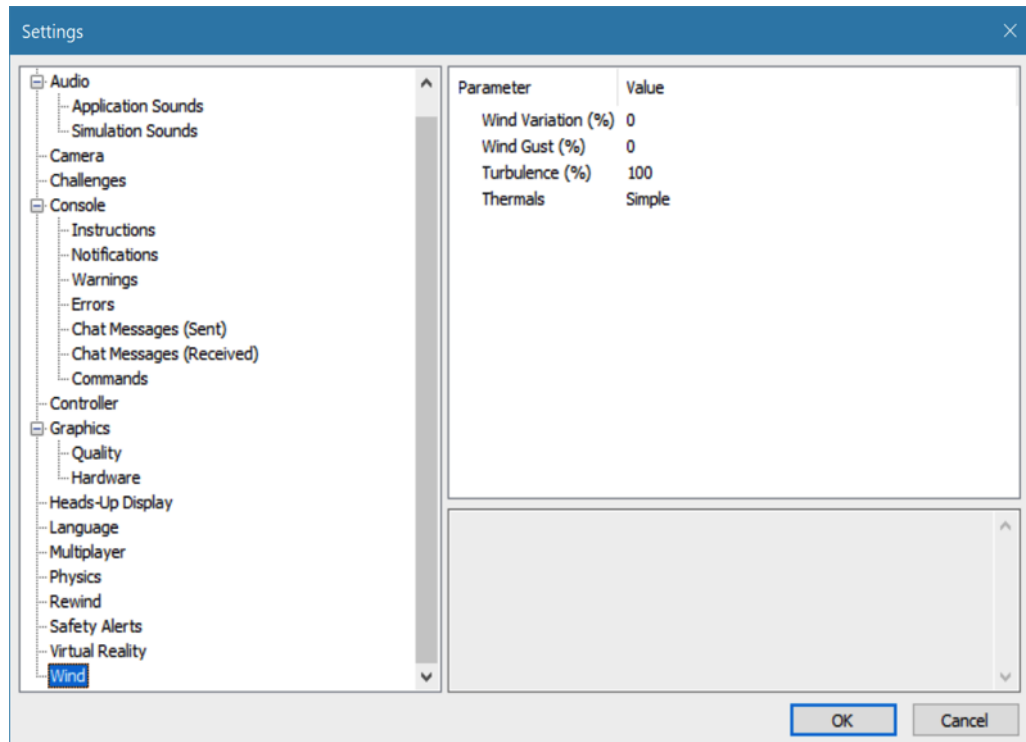

### Wind Variation (%)

This adjustment represents the variation in the wind speed and direction in relation to the average speed. Just as the winds that you experience at the local field are not constant, neither are the winds in RealFlight.

To adjust this variable, click on the value indicated to the right of the Wind Variation (%). Using either your keyboard or the mouse wheel, input a numerical value between 0 (unchanging) and 100. A higher value produces more dramatic changes in the wind.

### Wind Gust (%)

This value represents the change of the wind speed and direction corresponding to a proportion of the wind speed it calculates in one second.

To adjust this variable, click on the value indicated to the right of the Wind Gust (%). Using either your keyboard or the mouse wheel, input a numerical value between 0 (no changes) and 100 (large changes).

### Turbulence (%)

This option allows you to adjust the strength of the turbulence. Since this setting represents a median, some turbulence will be more severe, and some turbulence will be less noticeable.

To adjust the Turbulence Strength Proportion (%) settings, click on the value indicated in the column to the right of this option. The desired values may be input directly from the keyboard or modified using the mouse wheel. A value of 0% indicates that there will not be any mid-level turbulence.

### Thermals

This option allows you to adjust how much of the environment is affected by thermals. Setting this to **Simple** will only activate the thermals that are designed into the airport. **Dynamic** will cause thermals to be located throughout the entire terrain of the simulation. If you wish to fully enjoy bungee and aero tow, we suggest enabling Dynamic thermals.

Tab

## Capture Screenshot

Just like the perfect photo opportunity at the local flying field, RealFlight offers the chance to snap off screenshots. Captured screenshots are great to share with friends, add as your desktop wallpaper, or put on the internet for the world to see.

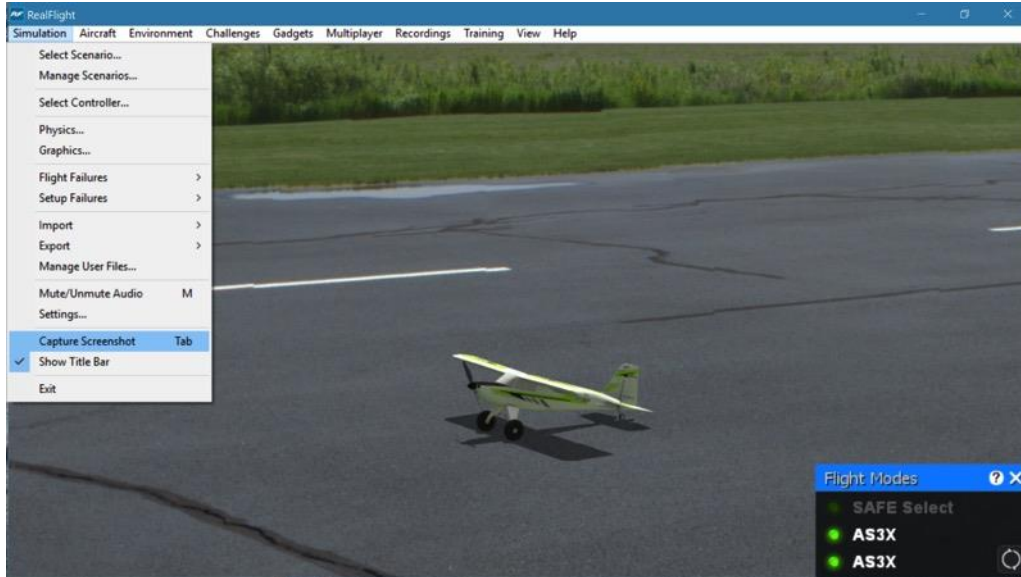

To snap a screenshot, click the **Capture Screenshot** menu item. Alternatively, press the **Tab** key on the keyboard.

Screenshots are stored in the My Documents folder. Each time a screenshot is captured, you will receive an on-screen notification as to the storage location.

## Show Title Bar

This menu item determines whether or not the RealFlight 9 title bar is displayed on the screen. By default, the title bar is enabled.

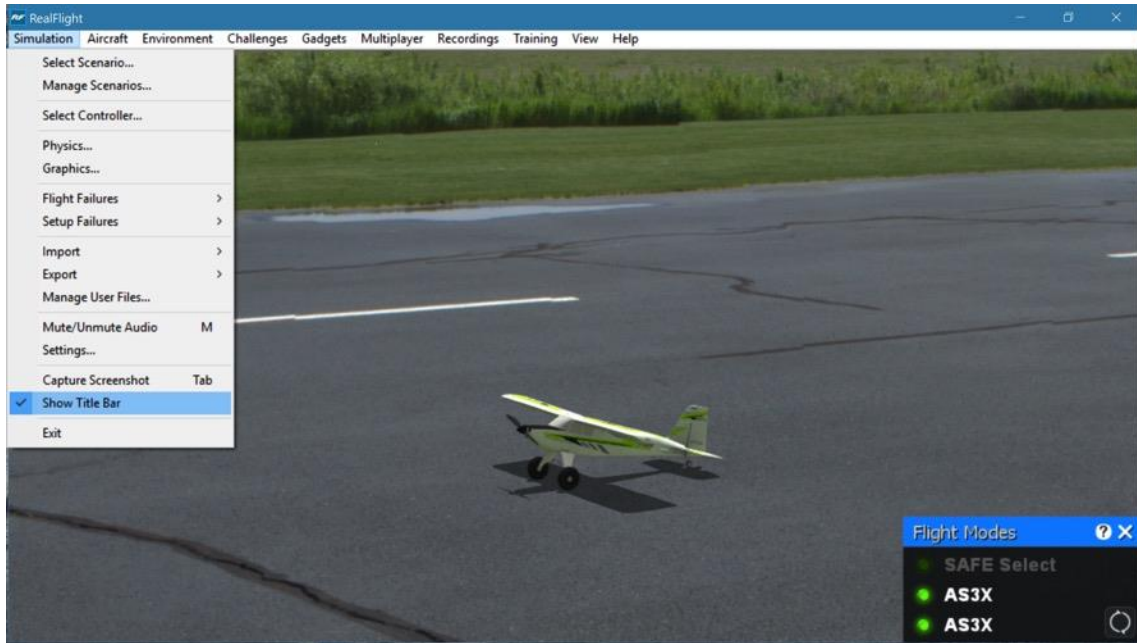

To access this menu item, click on the **Simulation** menu followed by the **Show Title Bar**. This will remove the RealFlight 9 title bar from the screen.

Please note: Removing the title bar also eliminates the ability to minimize or maximize the screen.

# Exit

Use this menu item to exit the program entirely.

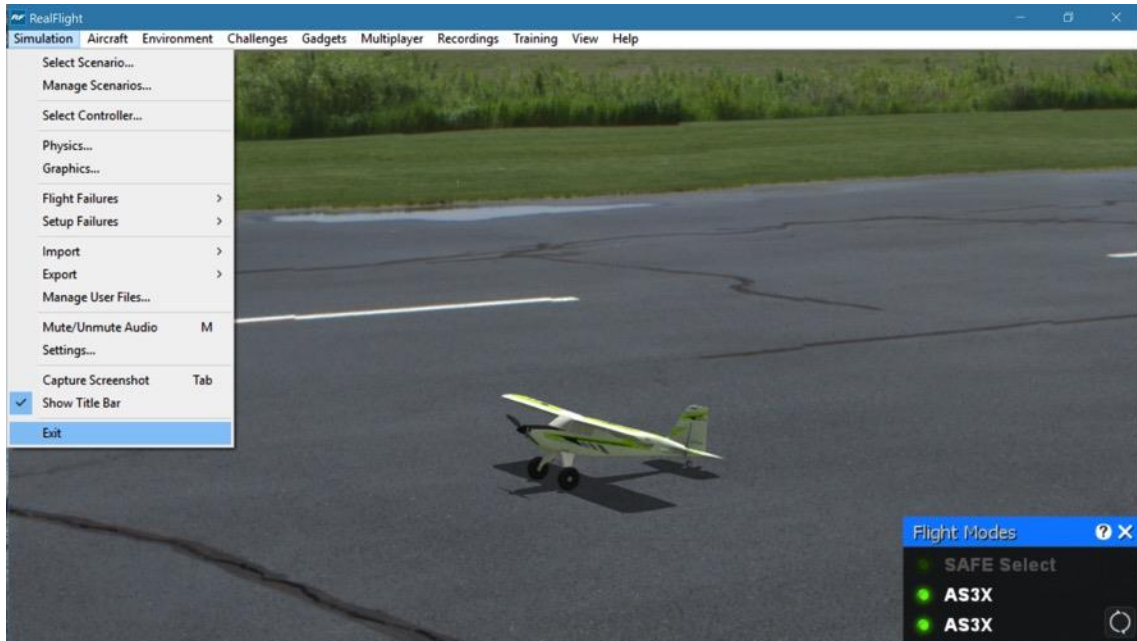

# The Aircraft Menu

*OFFERS ACCESS TO A VARIETY OF AIRCRAFT- RELATED FEATURES, FUNCTIONS, AND OPTIONS.*

Clicking the Aircraft menu brings forth a pull-down menu similar to the following screen shot.

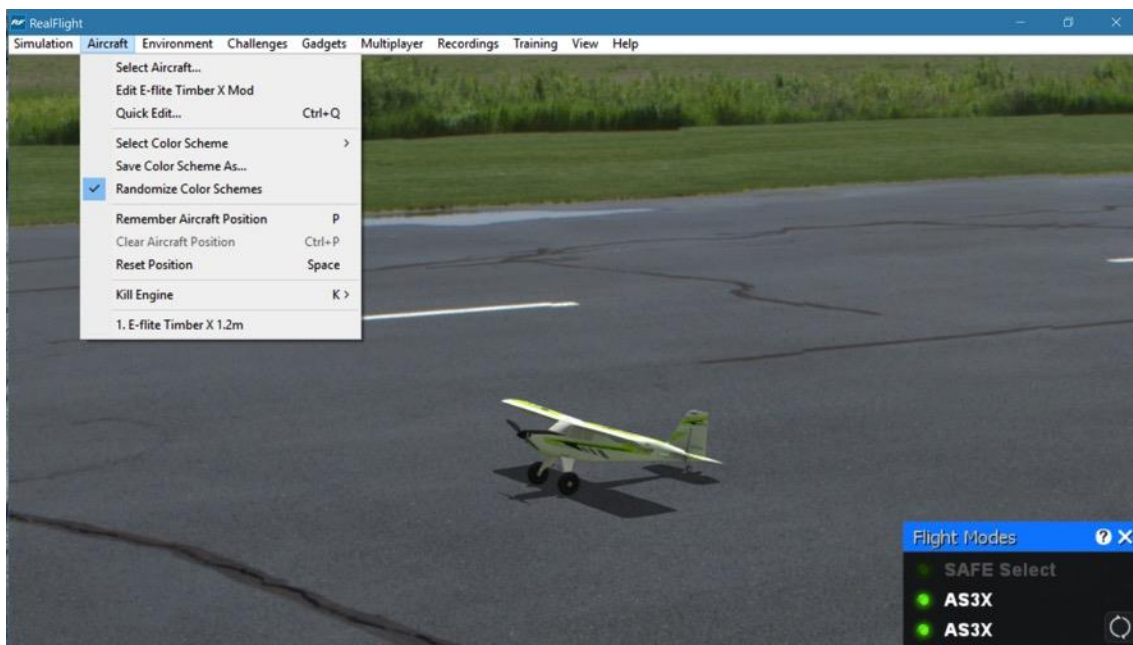

## Aircraft Selection...

When you click on **Select Aircraft...** the following dialog appears:

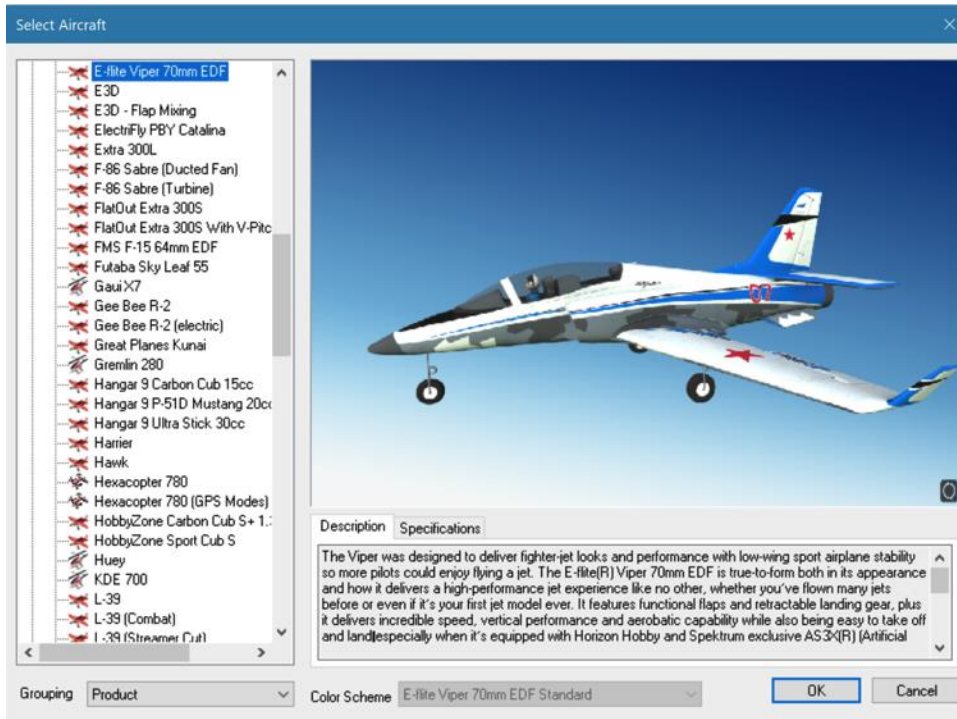

Change aircraft simply by using the InterLink DX. Press the **Scroll Wheel/Select** button, then, with the airplane tab highlighted, press the **Scroll Wheel/Select** button again. This will bring up the Select Aircraft QuickSelect dialog window. Use the scroll wheel in this dialog to rotate through the available aircraft. Press the **Scroll Wheel/Select** button once again to select a new aircraft, or press **Reset** to resume flying without making any changes.

If multiple trim schemes are available for an aircraft, the Color Schemes button on the screen will be illuminated. You can use the mouse to click this button, or press and hold the **Scroll Wheel/Select** button to display the list of different trim schemes. Roll the scroll wheel to select the desired trim scheme, press the **Scroll Wheel/Select** button to finalize this selection. To return to the aircraft list, press the **Cancel** button.

The list on the left of the dialog box displays all of the aircraft available to you. If you have created any customized aircraft, they will also appear in this list.

By default, the aircraft are listed in directories that have been optimized for ease of selection. For example, the aircraft in the RealFlight Legacy folder are either aircraft that are no longer in production or are what we consider legacy items. To make it easier, and more efficient, to find more recent offerings, these are included in the RealFlight 9 folder. Additionally, if you've created/imported any custom aircraft, these will be found in a Custom folder.

Click the **[+] (plus)** or **[-] (minus)** symbol next to the desired folder to reveal or hide the aircraft within these directories and folders.

### Aircraft Selection-

Every aircraft has its own unique flying characteristics, special features, and functions. To view an aircraft from the listings, simply use the mouse to click on the aircraft name. Alternatively, use the **up/down** keys on the keyboard to scroll through the list one aircraft at a time.

Click the **[+] (plus)** symbol to reveal the aircraft contained within the folder. Using either the **up/down** arrow keys on the keyboard or the mouse, select the desired aircraft from the listings. If utilizing the **up/down** arrow keys, click **OK** to finalize your selection. If using the mouse, double-click on the aircraft to load it.

Have some fun while you're in the Select Aircraft dialog! Using the mouse, click and drag the preview screen to point the camera angle to your choosing. Use the scroll wheel to zoom in and out or move the gimbals to see the control surfaces move. To resume rotating automatically, right-click the preview screen.

### Description/Specifications-

The pane below the Aircraft Preview box shows either the aircraft description or aircraft specifications. This box provides you with a brief history of the aircraft (if applicable) and serves to provide you with specific information pertaining to the model selected.

Using the mouse, select either the **Description** or **Specifications** tab.

### Grouping-

This list controls how the dialog organizes the list of available aircraft. By default, the aircraft are sorted by Product. Here is an explanation of the different sorting methods:

- **Product, Airframe:** The aircraft are first grouped into folders named by their parent product (i.e. RealFlight 9, Custom, Add-On, etc.). Within each parent product folder, the aircraft are further grouped into sub-folder by their Airframe names. For



example, “P-51 Mustang” and “P-51 Mustang (Combat)”, “P-51 Mustang (Paintball)”, and “P-51 Mustang (Streamer Cut)” are all found in the P-51 Mustang airframe folder.

- Product: Aircraft are grouped by product alone.
- Airframe: Aircraft are grouped alphabetically by airframe, not by product. Individual aircraft are grouped inside each airframe folder.
- None: There is no grouping at all. All aircraft are sorted alphabetically.

### Color Scheme-

If applicable, this list contains the alternative trim schemes for the selected model. If the Color Scheme dialog is grayed out, there are no alternative trim schemes available for this particular aircraft.

If the list control is active, click on the down arrow to reveal the alternate trim scheme(s). To select an alternate trim scheme, use either the **up/down** arrow keys on the keyboard or select one with the mouse. When an alternative trim scheme is selected, this scheme will appear immediately in the ReadySelect preview box replacing the previous trim scheme.

Modelers may also create their own trim schemes in RealFlight using a third-party bitmap editor capable of manipulating Targa (\*.tga) files. Please see the section titled “Save Color Scheme As....”.

## Edit Current Aircraft

RealFlight offers the user unparalleled freedom to edit or modify their aircraft. It's possible to add and remove components, alter their location, change airfoils, and much, much more! The first several times that you access the aircraft editor, the task might seem daunting. It may require some getting used to before you are comfortable with this feature and its related functions. The best way to do so is to simply dive in and experiment.

To modify the currently selected aircraft, click the **Aircraft** menu followed by the **Edit Current Aircraft** menu item. This brings up the Aircraft Editor dialog, which will allow you to modify any of the hundreds of parameters for the currently selected aircraft.



The Aircraft Editor dialog will have an appearance similar to the screen shot shown above. It may deviate slightly depending upon the type of aircraft that you are editing (i.e., biplane, electric model, etc.), as well as the editing tab selected (Vehicle, Physics, Electronics, etc.). However, all aircraft are edited in a similar manner. This section presents you with the general information necessary to edit any aircraft found in the RealFlight 9 offering.

### Aircraft Editor Menus-

Selecting the **Edit Current Aircraft** option activates the screen shown above.

#### File Menu-

This menu and its menu items are used to manipulate and control the various folders and related items in the aircraft editor.

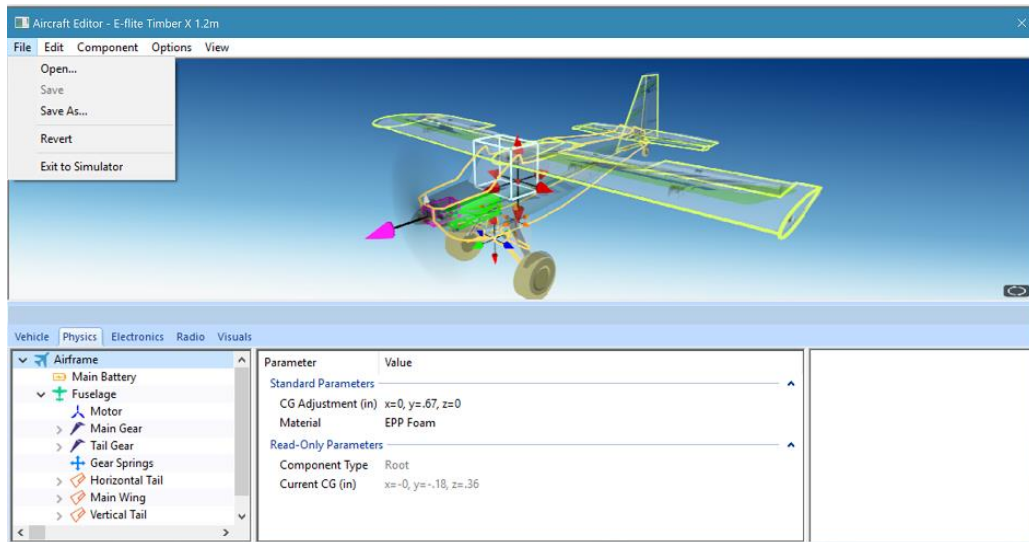

### Open...-

This menu item is used to open existing and edited aircraft. Selecting this menu item opens the Select Aircraft dialog. To select an aircraft from this list, follow the procedure described in the Aircraft Selection section of this manual.

### Save-

This option becomes active once you have renamed and saved the edited aircraft. Prior to doing so, this option will remain inactive and grayed out. This allows you to make further modifications to the aircraft without renaming it each time.

### Save As...-

Upon completion of the aircraft editing, click this menu item to rename and save the modifications. You will be asked to create a name for this new aircraft. After you have renamed the aircraft, click **OK** to accept the new name. Afterward, the aircraft will appear in the aircraft listing found under Select Aircraft... in the Aircraft menu.

### Revert-

This menu item allows you to revert, or go back to the settings the last time the aircraft was saved. If you have not previously saved the aircraft, the aircraft will return to the default settings.

To use this menu item, open the **File** menu and click **Revert**. This will bring forth the verification dialog. Click **Yes** if you wish to return to the last saved version of this model.

Please note: Any modifications performed after the last time this model was saved will be lost. Clicking **No** will allow you to save the modifications or continue refining the aircraft.

#### **Exit to Simulator-**

This menu item returns you to the simulation. If you have performed any modifications to the aircraft and have not saved these modifications, a verification dialog will appear. Choose **Yes** to save the modifications. If you select **No**, the modifications will be lost. Selecting **Cancel** will return you to the editing dialog.

## Edit Menu-

As is suggested by the name, this menu is utilized to edit the aircraft. This menu may be used for some simple editing functions on the current aircraft.

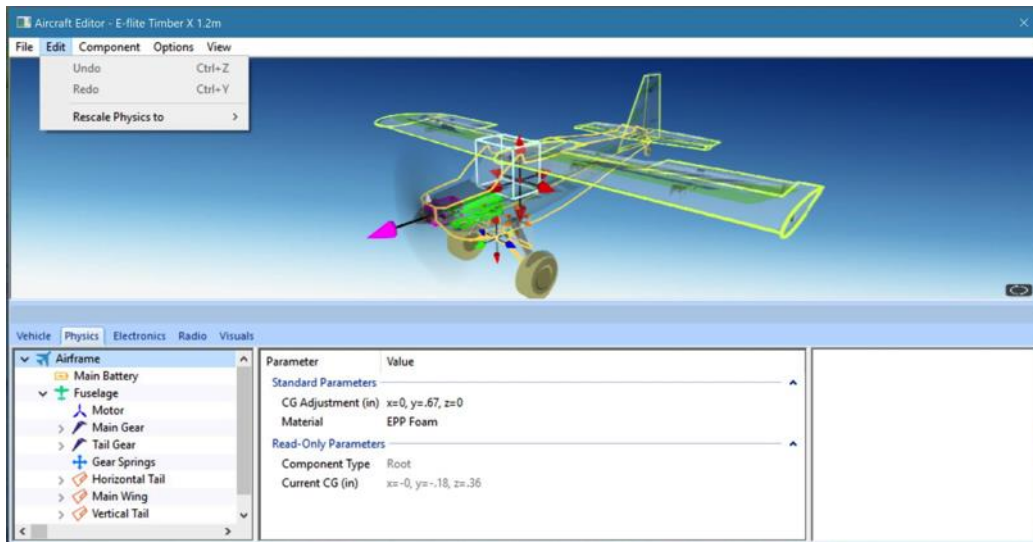

## Undo-

Select this to undo the last change you made in the aircraft editor.

## Redo-

Choose Redo to repeat the last action you performed in the aircraft editor.

## Rescale Physics to-

This setting is used to alter the physics calculations utilized for the aircraft. Select one of the predetermined percentages from the sub-menu items, or select the custom option and input the percentage desired.

Use this option to refine the flight characteristics of the selected aircraft accordingly.

## Component Menu-

As is suggested by the name, this menu is utilized to edit the aircraft. This menu may be used for some simple editing functions on the current aircraft.



### Cut-

Select a part on the aircraft and choose **Cut** to remove the object. The part is stored temporarily in RealFlight's memory and can be pasted back onto the aircraft later, if so desired.

### Copy-

Like the Cut option, Copy will store the selected part in RealFlight's memory allowing you to later paste it into the aircraft. Unlike Cut, the selected part will remain at the current location.

### Paste-

If any aircraft part has been cut or copied, choose **Paste** to add it to the current aircraft.

### Add-

As the name suggests, this enables you to add items to the aircraft. For example, if the aircraft name is highlighted and the Edit menu is selected, there will not be any actions available to you. If the airframe is highlighted, the aircraft editor will allow you to add various components to the airframe.

If you wish to either add or remove an item from one of the aircraft components, right-click on the respective component. This will bring forth the available options.

When editing aircraft, you can click and drag the mouse in the preview area to rotate the aircraft to different angles. Additionally, it is possible to enlarge or shrink the aircraft representation within this preview box. Doing so helps to better see components you might be modifying.

#### **Delete-**

Delete will remove the selected part from the aircraft. It cannot be retrieved later. Therefore, you cannot paste the part back onto the aircraft.

#### **Rename-**

Delete will remove the selected part from the aircraft. It cannot be retrieved later. Therefore, you cannot paste the part back onto the aircraft.

## Options Menu-

This menu provides you with a number of choices or options available in the aircraft editor.

Selecting the Options menu brings forth the drop-down menu items discussed below.



### Play Engine Sounds-

Selecting this menu item plays the respective engine sounds during the editing of this aircraft.

Please note: This setting is only temporary. That is, this setting is not retained after you exit the aircraft editor.

To select this option, click the **Play Engine Sounds** menu item. This will place a check mark before the setting and return to the aircraft editor. The engine sounds will become audible.



### Control Surface Deflections-

Selecting this menu item displays the deflection, either Simple or Advanced, of the selected control surface. If using ailerons, for example, and Simple is selected, the parameter available to modify will show only the maximum deflection. If, however, Advance is selected, the maximum, minimum and center deflection parameters will be visible for editing.



### Units-

This option toggles the units of measure between metric and SAE units. It is important to note that modifying this option affects all measurements in the



simulation. For example, changing from SAE to metric in the editor also affects the airport editor dialogs.

To modify this option, click the **Display Metric Units** setting. Then select the unit of measurements you would prefer from the drop-down menu. The options are **English** or **Metric**. A check mark will appear next to the unit that is currently displayed.



#### **Reload Color Scheme-**

This option allows you to view the results of an edited trim scheme.

There are two ways that you can do so. The first is to use the **Select Color Scheme** menu, which is found within the **Aircraft** menu. Simply click on the color scheme that you have just edited, and RealFlight will reload the color scheme onto your aircraft and reset the aircraft back on the runway.

Alternatively, within the aircraft editor, click on the **Options** menu item. Select **Reload Color Scheme**. Clicking this reloads the color scheme, showing any changes you have made to the aircraft. To improve visibility of the trim scheme, you may wish to remove the wireframe from the preview. To do so, please follow the procedure noted in the description for “Show Wireframe.”



#### **Fuel Level-**

In the aircraft editor, the mechanics of the aircraft will be running to allow you to see how it functions. If you prefer, you can set the fuel level to empty, which will essentially kill the motor.

Select the **Fuel Level** menu item, and then click your preference.

## View Menu-

The View menu in the aircraft editor offers choices on the perspectives of the aircraft in the preview window.

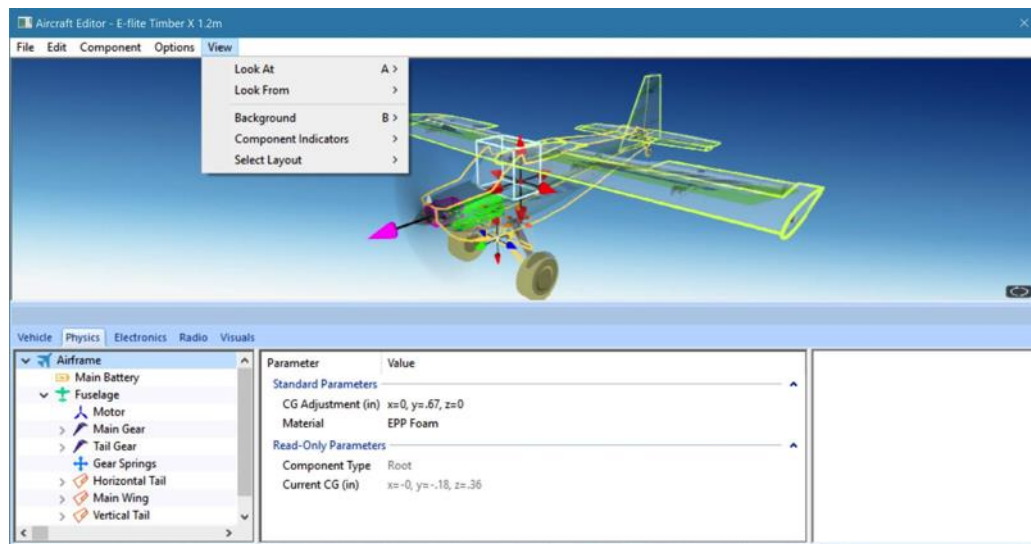

### Look At-

This option allows you to determine the view of the aircraft being edited. There are three options available from this menu.

- Aircraft Center- Check this option if you wish to keep the entire aircraft centered in the view.
- Component Center- Check this option to center the view on the component you are editing. For example, if you are modifying the rudder, the aircraft will shift, so that the rudder appears in the center of the preview area.

To adjust the Look At perspective, click the **Look At** menu item and select the desired view. Alternatively, you may use the 'A' key on the keyboard to toggle through the aforementioned selections.

### Look From-

You can select from pre-determined angles from the Look From menu item. They include:

- Above – Look from above the aircraft. Or press the Q key to quickly change to this view.
- Below – Look from below the aircraft. Or press the Shift-Q keys to quickly change to this view.

- Right – Look from the right side of the aircraft. Or press the W key to quickly change to this view.
- Left – Look from the left side of the aircraft. Or press the Shift-W keys to quickly change to this view.
- Front – Look from the front of the aircraft. Or press the E key to quickly change to this view.
- Back – Look at the back of the aircraft. Or press the Shift-E keys to quickly change to this view.



### Background-

This option displays a sub-menu that allows you to change the background color of the preview pane. Depending on personal preference, or the colors of the trim scheme for the aircraft that you are editing, you may want to change the background color to make the aircraft easier to see.

To adjust the background color, click the **Background** menu item and select the desired color.

### Component Indicators-

When the wireframe is visible, each component is represented by small wireframe indicators. For aircraft that include many components, these indicators can sometimes get in the way and make things confusing.

There are two methods to assist you with reducing or removing the visibility of components.



- Size – By default, all component indicators are large. Switch to small to reduce the chance of each indicator overlapping in the wire frame.



- Visibility – For aircraft with a large number of components, you may wish to change their visibility to **Selected Component Only**. Then, only the component you have selected will be visible, while all others will disappear. Those components still exist, they just won't be visible.

### Select Layout-

There are two default layout options available from the sub-menu. They will alter the way the different panes in the aircraft editor window are positioned. The options will change the aircraft editor layout as follows:

Layout 1:

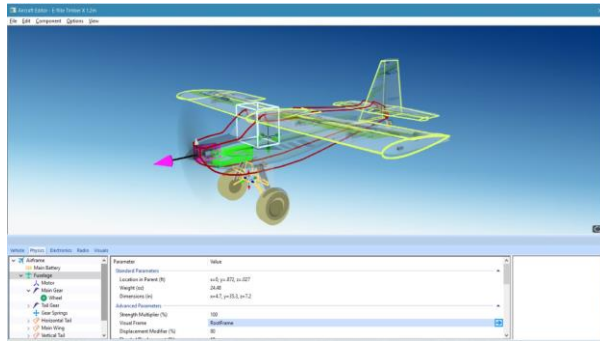

Layout 2:

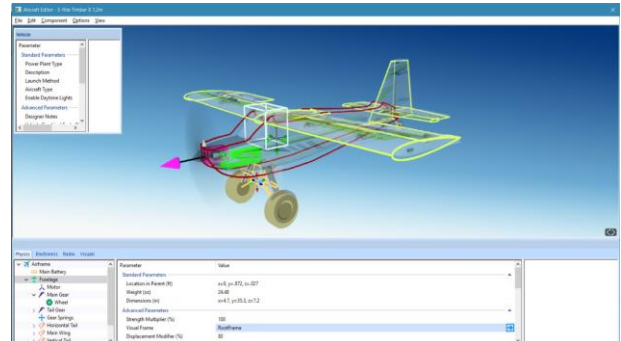

## Parts Tree-

The Aircraft Editor contains three important areas: the Parts Tree, Parameter window, and the Description pane.

The Parts Tree and Parameter screen are also further grouped into a number of different tabs.

- Vehicle – This tab will only display a Parameter window. The options here are more general, affecting the overall aircraft.
- Physics – This tab allows you to view and edit physical components of an aircraft, like the wings, fuselage, and landing gear.
- Electronics – Select this tab to view and edit parameters for the aircraft's electronics, like servos.
- Radio – To view and modified the built-in radio programming for the aircraft, select this tab.
- Visuals – More advanced users that create their own aircraft for RealFlight from scratch will use this tab to match the graphical parts with the physical parts.

There might be times where you want multiple tabs visible at the same time. For example, you may want to modify the programming for the radio that will then affect one or more servos. Those servos are then linked to certain control surfaces. In this case, it might be of some assistance to be able to view Radio, Electronics and Physics tab at the same time.

Luckily, the Aircraft Editor in RF9 allows you to do this with ease. Simply click and drag a tab and move it to another location on the screen. The tab can float independently, or lock to the edge of the Aircraft Edit screen as desired.

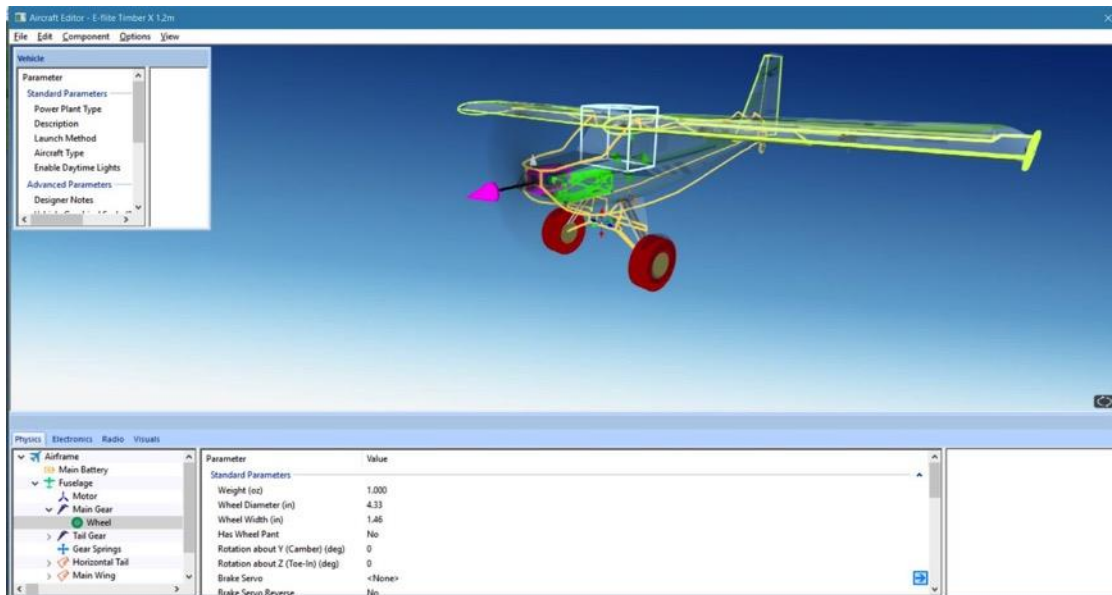

The Parts Tree breaks down the list of aircraft components and radio data, depending on the tab selected, into an easy-to-use hierarchy.

For example, with the Physics tab visible, the first item listed is *Airframe*, which is considered the root item for all other items listed here. Selecting it will offer a variety of common parameters that you can edit in the Parameter window.

Below the *Airframe* there are additional options that allow you to customize the individual parts of the aircraft. Similarly, you also have the ability to modify the electronics and radio program for the aircraft in the *Electrons* and *Radio* tabs, respectively.

Each part belongs to a higher component, or parent, with the root being the highest component. In return, it's possible that the part itself also has children parts that belong to it. For example, if you wish to edit the wheel diameter on the Timber X, you will find it under the following path in the Parts Tree:



## ➔ Physics Tab

- ➔ Airframe – Contains all the physical parts of the aircraft, such as wings, fuselage, etc.
  - ➔ Fuselage – One of many physical parts found in the Airframe
    - ➔ Main Gear – The Main Gear on the Timber X attaches to the wing, therefore, is listed under the Fuselage part.
      - ➔ Main Wheel – Finally, you'll see the wheel component which, understandably, is found under the Main Gear part.

Once the Main Wheel is selected, the Parameter window will change to show all parameters available to the Main Wheel. You'll notice that one of these parameters is wheel diameter.

All other parts are found and modified in much the same way. However, if you are unsure as to the location of a part, an easier way to access the part is to click on the desired item in the Preview screen on the top half of the window. For example, if you want to modify the parameters for the horizontal tail of the Timber X, simply click on that portion of the image. You'll notice that the Horizontal Tail is now selected in the Parts Tree.

## Preview Screen-

As mentioned above, to quickly find the part in the Parts Tree for modification, you can simply click that part in the Preview screen itself. At times, you'll notice that the part you want to click might be hidden behind another section of the aircraft. If you find yourself in this situation, click and drag the mouse cursor around the Preview screen. This will rotate the

aircraft image around, so you may view it from different angles. You may also use the scroll wheel on the mouse to zoom in and out for a closer look at the section you are working on.

## Parameter Window-

The final component of the on-screen layout is the Parameter window. This window will list all the parameters available for the currently selected part in the Aircraft Parts Tree.

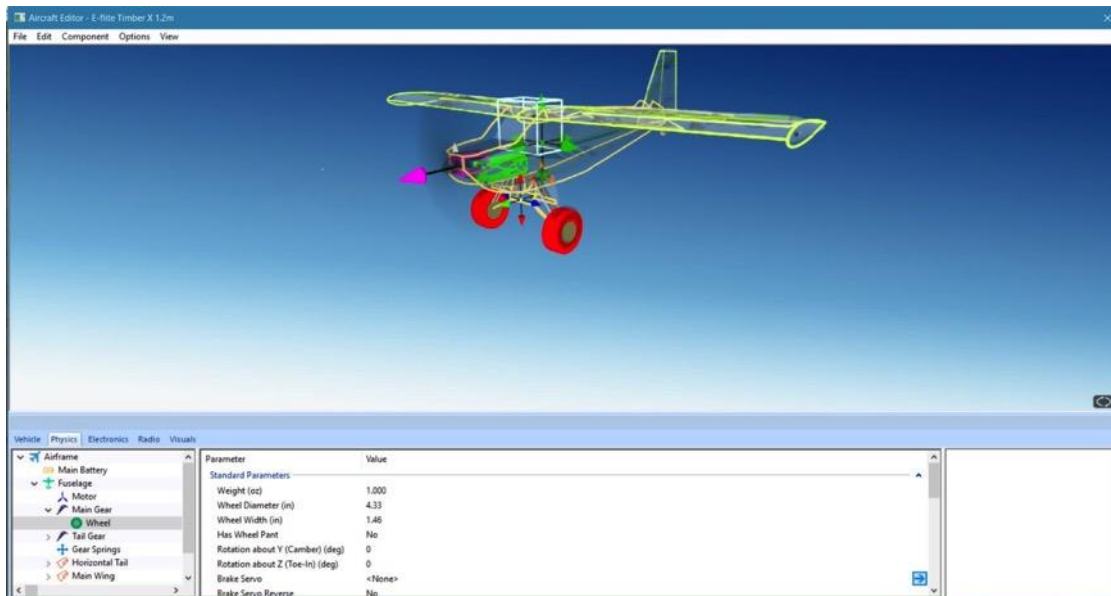

Clicking on the parameter will allow you to view a description of its use in the Description pane next to the Parameter window. This will also allow you to modify the currently selected parameter.

## Adding and Removing Components-

There are times when you may want to add a new component to the aircraft. The first step is to determine the location for the new part. For example, if you were to add flaps, it makes more sense to add them to the main wing, than to the fuselage.

After determining a location for the new part, you can add it in one of two ways. Select the new part from the **Component** menu then click on the component to which you are adding the new part from the **Add** sub-menu. Alternatively, right-click on the **Main Wing** component in either the Parts Tree or in the Preview screen, then select the **Add** sub-menu.

Removing a component works in much the same way. In the Parts Tree, select the component you wish to remove and then select **Delete Component** from the **Component** menu. You can also accomplish the same thing by right-clicking on the part to remove and selecting **Delete**.

## More Information-

The Aircraft Editor may seem a little overwhelming at first. The best way to become familiar with the editor and its related functions is to simply use it and start experimenting. RealFlight does not allow you to customize the stock aircraft. If you want to make a change to one of the stock aircraft, you will be forced to save it under a new name. Therefore, you always have the stock aircraft to default to should the need arise.

Our online forums and swap pages provide a great source of information and assistance from other RealFlight users. These pages may be found at:

[www.knifeedge.com/forums](http://www.knifeedge.com/forums)



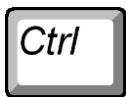

## Quick Edit...



This window allows you to make quick, simple changes to the aircraft without opening the full Aircraft Editor. Often times, you may feel that simple changes, such as the amount (expressed in degrees) of rudder deflection are all that is needed to make an aircraft fly more like your model. Instead of working through the complexity of the Aircraft Editor, you may make the change rapidly using RealFlight's Quick Edit.

When you click on **Quick Edit...** a window similar to the following appears:

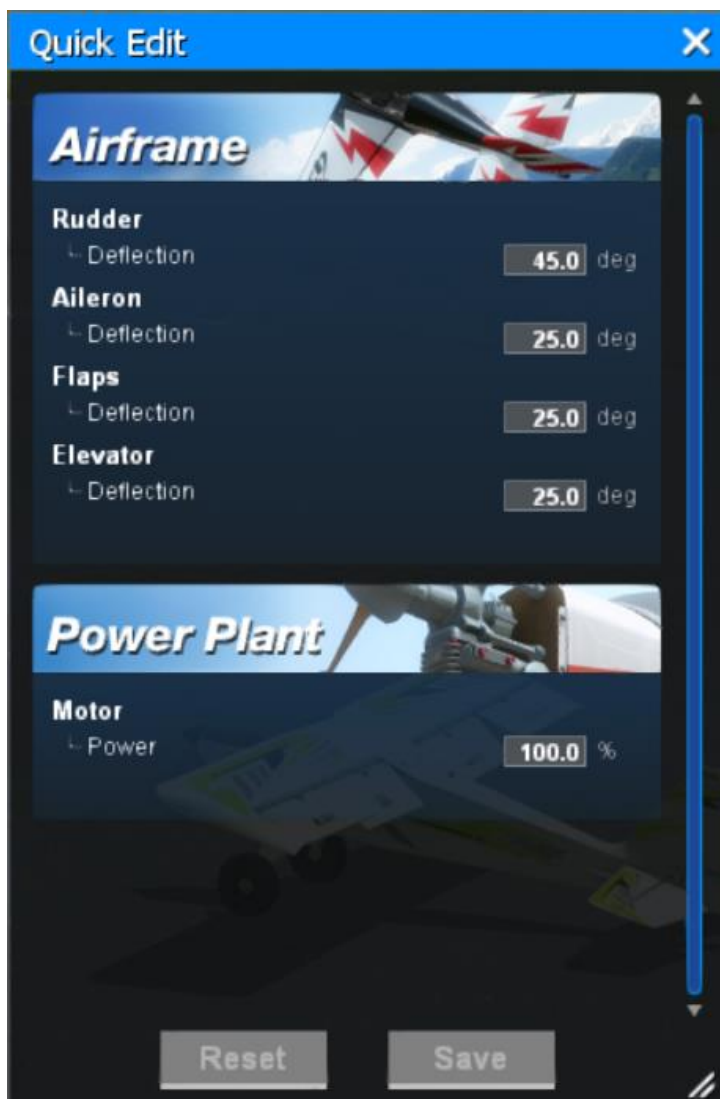

To make such simple refinements to the respective aircraft, click the **Aircraft** menu followed by **Quick Edit**. The Quick Edit dialog will appear, showing the adjustment options.

Changes made through the Quick Edit will make a copy of the aircraft and save it as a custom aircraft with “(Quick Edit)” appended to the name.

## Select Color Scheme

This menu item allows you to quickly choose an alternative trim scheme (if available) for the current aircraft.

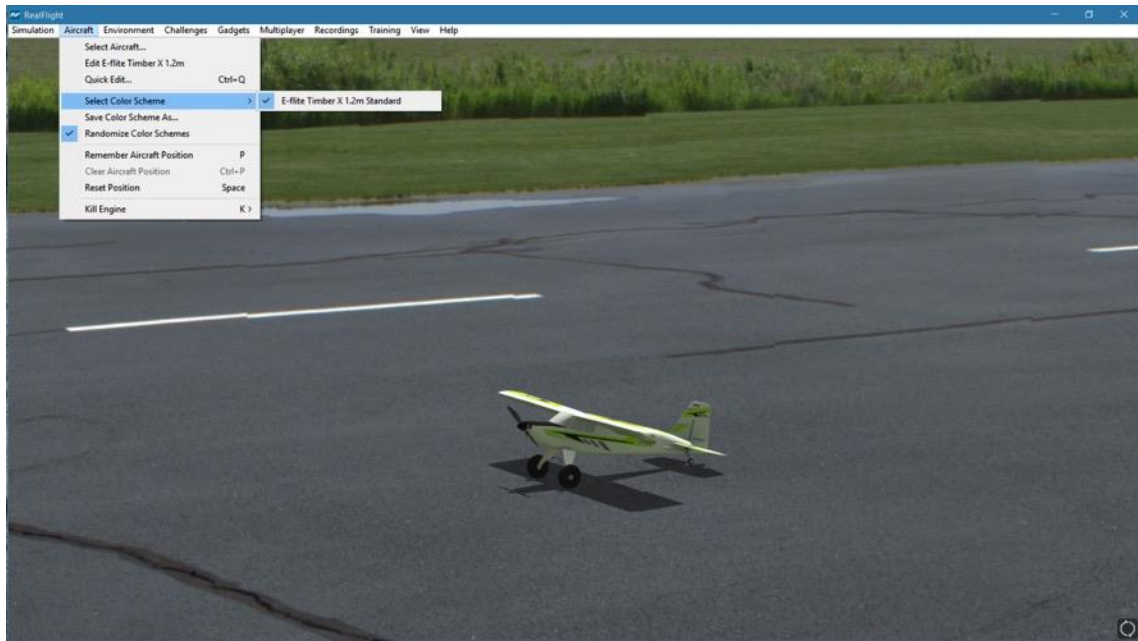

To view the alternative color schemes, click the **Select Color Scheme** menu item. To select an alternate trim scheme, click the desired selection in the value box. Alternatively, you may use either the Up/Down arrow keys on the keyboard, or the mouse to select the desired scheme option. If utilizing the arrow keys, press **Enter** to finalize the selection. The new trim scheme will appear immediately on the aircraft. Please note: if only one scheme appears in the pull-down menu, alternative schemes are not available for this aircraft.

## Save Color Scheme As...

This menu item is used to create an editable version of the currently selected trim scheme.

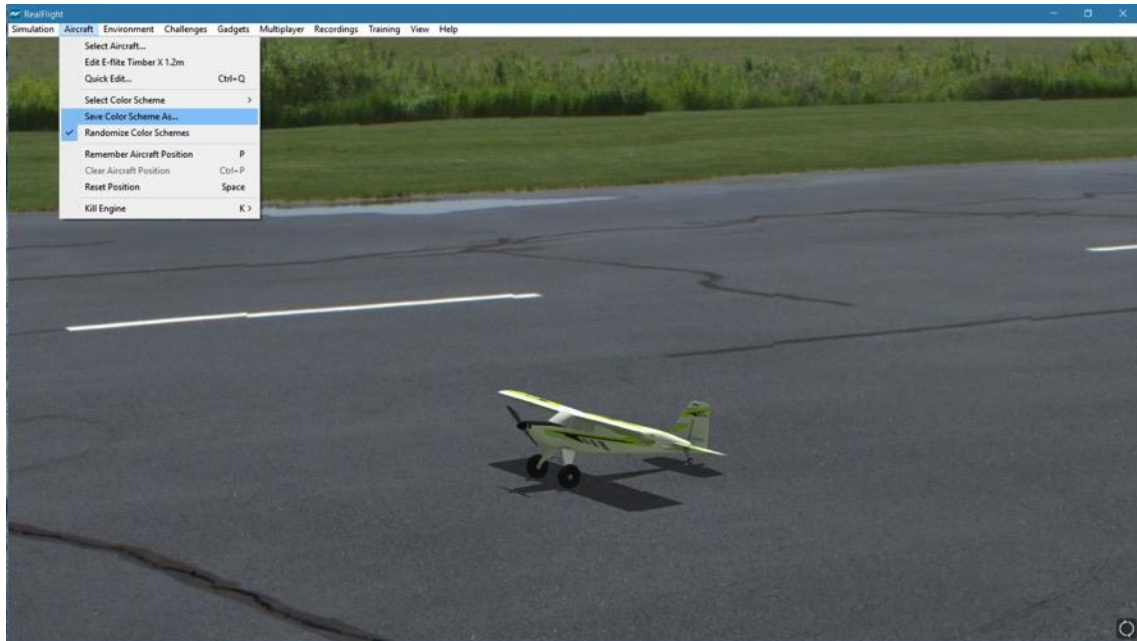

RealFlight allows you to create a custom paint/decal scheme for your aircraft. The color schemes you create are limited only by your imagination.

However, only individuals that own and know how to use a third-party bitmap editing program such as Adobe® Photoshop® should attempt to create a custom color scheme. Your editor must be able to read and edit Targa (".tga") files.

To create a custom color scheme, click the **Save Color Scheme As...** menu item. Enter the desired name in the dialog box that appears. The location of the file will appear in the lower left corner of the RealFlight screen.

To access the file that contains the custom color scheme, open the My Documents folder. Next, open the **RealFlight 9** folder followed by the **Vehicles** folder. A number of folders are available here; open the folder called **ColorSchemes**. This will bring up all of the custom color schemes that have been stored in RealFlight. The name of the aircraft will precede the name that you have selected for your custom color scheme. Click on the file for which you wish to modify the trim scheme.



***DO NOT ALTER THE NAME OF THIS FILE, AS REALFLIGHT MAY NOT BE ABLE TO CORRELATE THE COLOR SCHEME WITH THE AIRCRAFT.***

Once you have finished editing and saving your color scheme, you will probably want to see the results of your work. There are two ways that you can do so. One is to use the Select Color Scheme menu, which is found within the Aircraft menu. Simply click on the color scheme that you have just edited, and RealFlight will reload the color scheme onto your aircraft and reset the aircraft. Within seconds, you are ready for flight with your new color scheme.

Alternatively, access the Aircraft Editor (see section Edit Current Aircraft on page 128). Within the aircraft editor, look for Reload Color Scheme which is located in the Options menu. Clicking this will reload the color scheme, showing any changes you have made to the aircraft. You can disable the wireframe using the Options menu to improve your view.

While looking in the Color Schemes directory for your new color scheme, you may also notice a “.color scheme” file with the same name as the “.tga” file. This file can be opened in a text editor such as Notepad. Within the file, you will find six values to edit: Specular, Reflectivity, Power Specular Off, Power Specular On, Power Reflective Off, and Power Reflective On.

Specular - A multiplier for the overall specularity of the aircraft. Specular=1 is neutral, Specular=0 disables specular highlights.

Reflectivity - A multiplier for the overall reflectivity of the aircraft. Reflectivity=1 is neutral, Reflectivity=0 disables reflections.

Specular highlights vary from fully off to fully on as the specular power of each piece of the aircraft goes from the value Power Specular Off to Power Specular On.

Reflections vary from fully off to fully on as the specular power of each piece of the aircraft goes from the value Power Reflective Off to Power Reflective On.

### Tips for Color Schemes-

- A quick and easy way to change a color scheme is to replace one color with another. Photoshop has a command that can easily do this called, “Replace Color”.
- Make sure you save the file as 32 bit TGA files, so that the Alpha Channels are preserved (See below).
- You are only allowed a single Alpha Channel.
- Do NOT alter the resolution of the image.
- Other formats (JPG, BMP, etc) are not allowed.

## Alpha Channels-

Almost all of the color schemes for the aircraft incorporate an Alpha Channel, which defines what areas of the color scheme are opaque and what areas are transparent. White portions of the alpha channel will be 100% opaque and Black portions of the alpha channel will be 100% transparent. Shades in-between will be partially transparent.

Consult the image editor's manual to determine how to properly use Alpha Channels.

Please note: RealFlight uses TGA files instead of the BMP format. This is because BMP formats do not support alpha channels.

## Randomize Color Schemes

When this menu item is checked, RealFlight will randomly choose a color scheme for the selected aircraft, if multiple schemes are available. Uncheck this menu item to disable this feature.

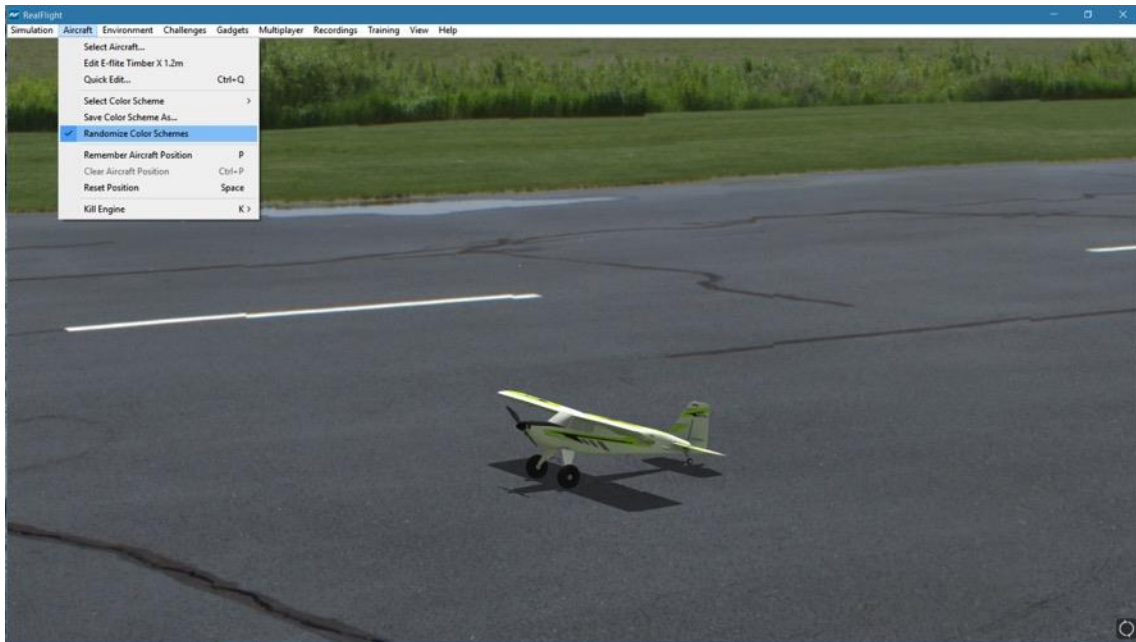



## Remember Aircraft Position

The Remember Aircraft Position menu item saves the current position of the aircraft. When you reset the aircraft, it will return to the same position (speed, attitude, heading, etc.). This feature is ideal for practicing maneuvers, such as an autorotation in a helicopter.

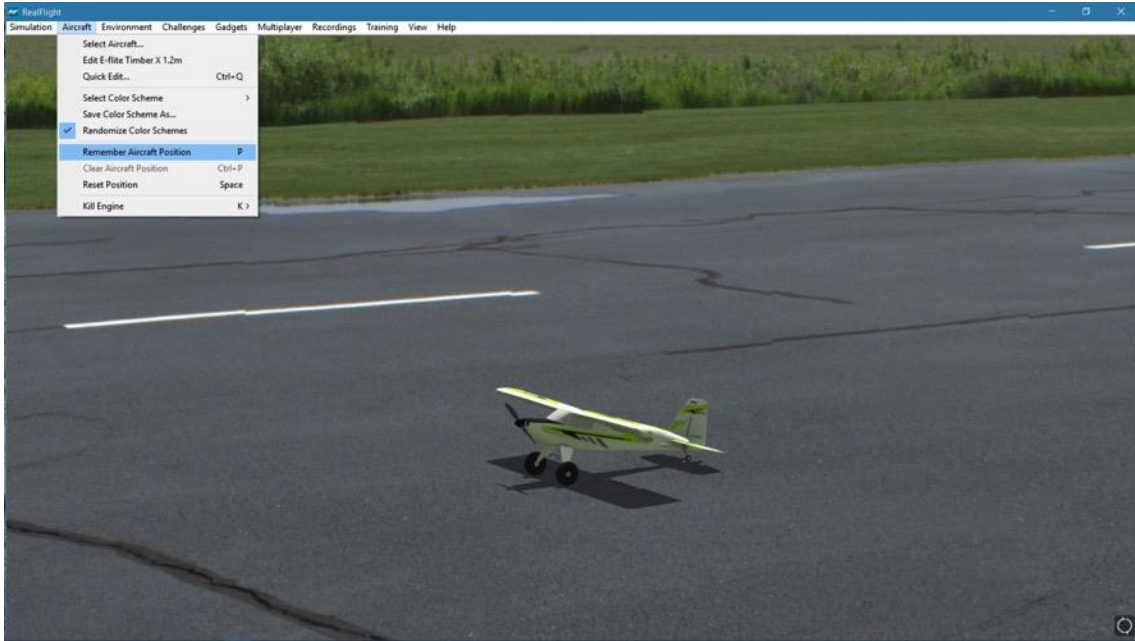

To activate this menu item, click the **Remember Aircraft Position** menu item when the aircraft is in the desired location and altitude.

Each time the aircraft is reset, it will begin flight from the saved location.

Please note: The saved position is only temporary. If you select another airport, aircraft, or if you exit the simulation and restart, you will need to save the desired position once again.

## **Ctrl** Clear Aircraft Position

This menu item clears the position saved in the Remember Aircraft Position without exiting the simulation, changing flying sites, and/or aircraft.

**P**

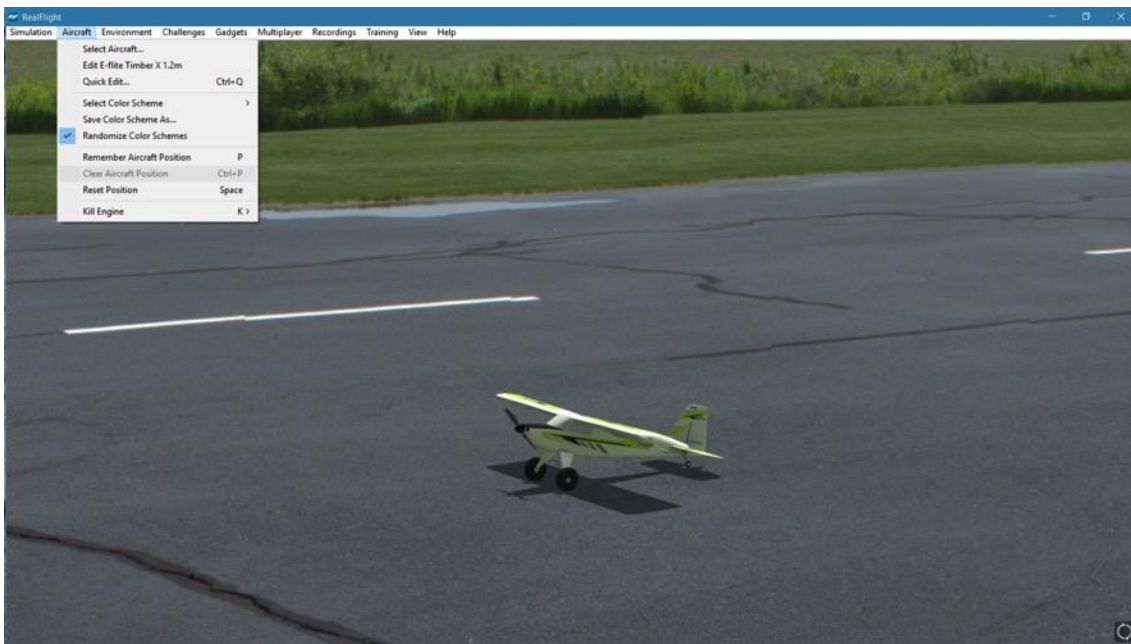

To do so, simply click the **Clear Aircraft Position** menu item. When the aircraft is reset, it will return to one of the default starting positions.



## Reset Position

There are three ways to reset the aircraft to its takeoff position:

1. Press the **Reset** button on the InterLink DX controller. This is probably the fastest and simplest method.
2. Press the keyboard's space bar.
3. Click the **Reset Position** menu item.

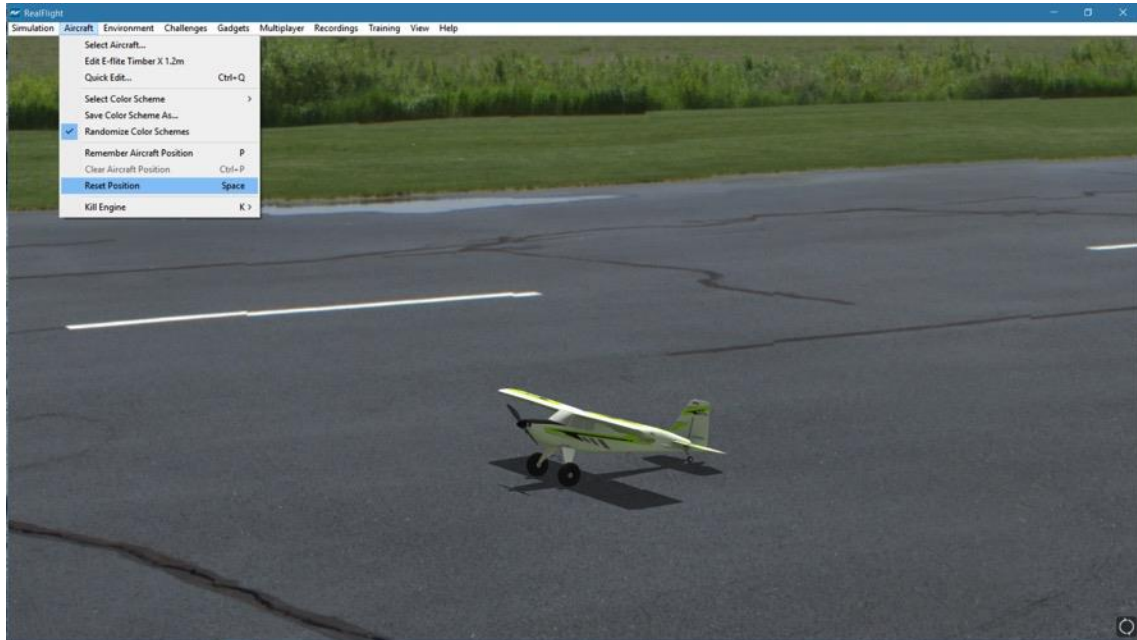





## Kill Engine

Click on this item to instantly stop the motor from running. This is useful when you are practicing dead-stick landings in airplanes and practicing autorotation for helicopters.

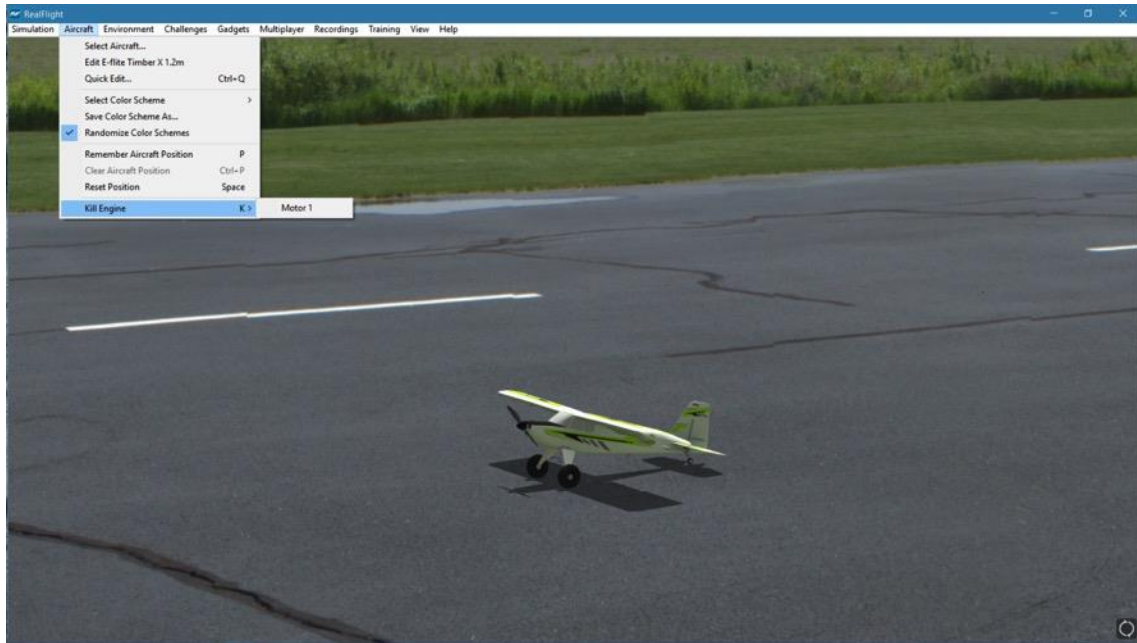

If the aircraft has multiple motors, the sub-menu will allow you to select which motor to kill. Alternatively, pressing 'K' on the keyboard, or selecting **Random** will kill one of the motors at random.

## Aircraft MRU

The final items in the Aircraft menu indicate the most recently used aircraft. The MRU shows only the eight most recently selected aircraft.

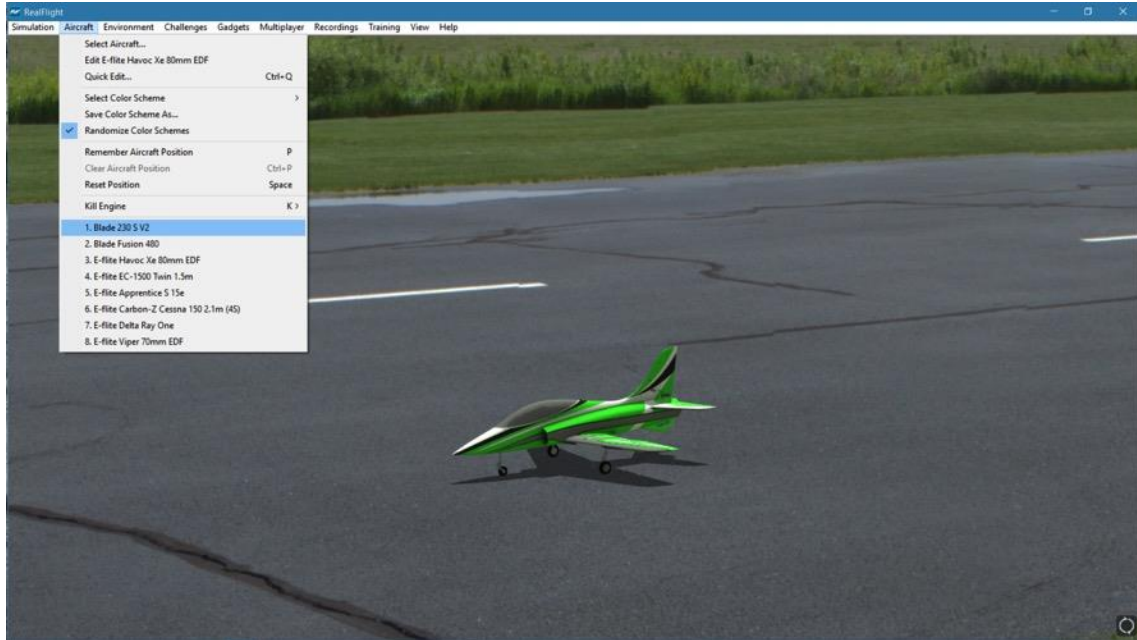

You can load an aircraft by selecting it from this list. This shortcut allows you to switch amongst your favorite aircraft without using the Select Aircraft dialog.

# The Environment Menu

*ALLOWS ACCESS TO A VARIETY OF ENVIRONMENT-RELATED FEATURES, FUNCTIONS AND OPTIONS.*

The Environment menu gives you access to many scenery related features, such as changing flying sites, or adjusting weather related items.

Clicking the Environment menu will open the drop-down menu as illustrated in the following screen shot.

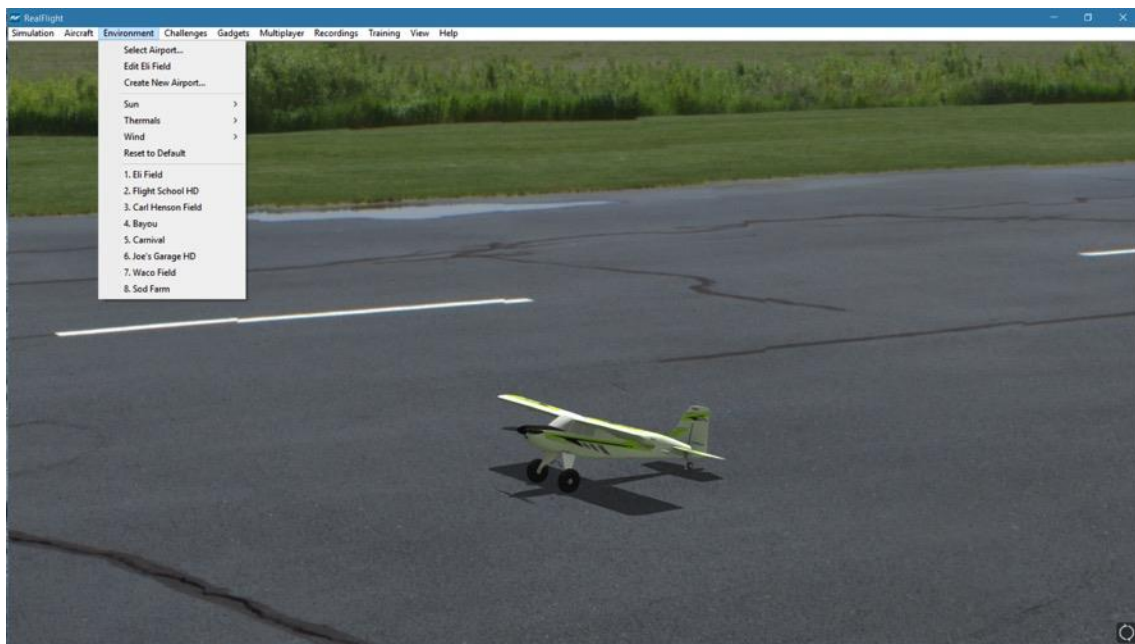

## Select Airport...

When you click on **Select Airport...** the following dialog appears:

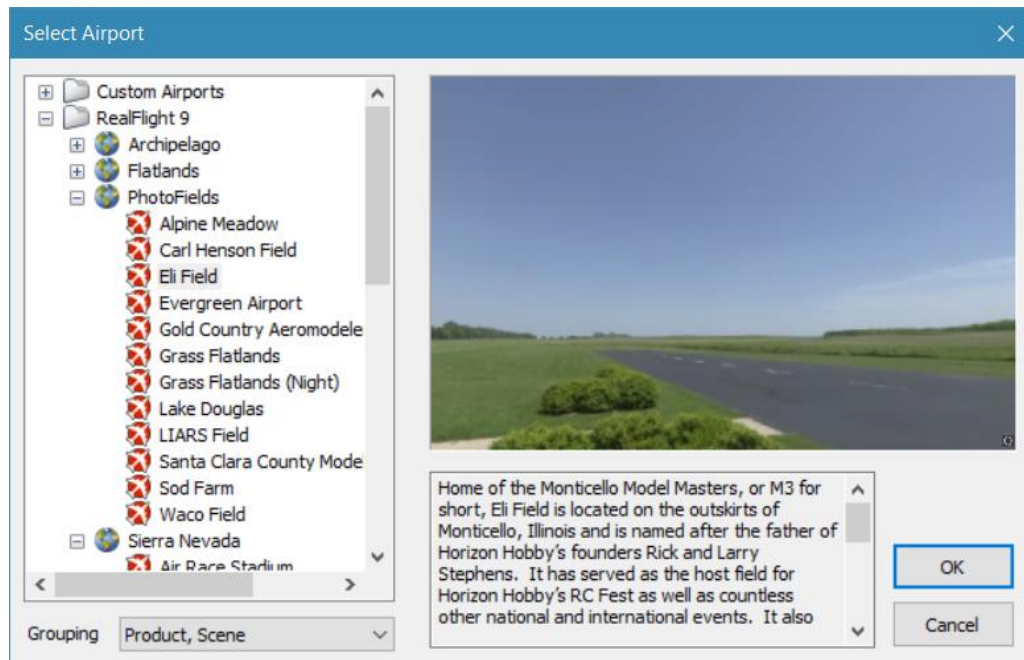

RealFlight 9 offers two different types of flying sites: 3D and PhotoField. PhotoField, as the name suggests, are flying sites created from photo imagery. 3D flying sites are, again as the name suggests, sites rendered in a 3-dimensional environment. If the PC is running slowly at a 3D flying site, try selecting a PhotoField site.

This dialog lets you choose the flying site that you wish to use for your flight. Each location offers its own unique characteristics and challenges.



Change airports simply by using the InterLink DX. Press the **Scroll Wheel/Select** button, then use the scroll wheel to highlight the runway icon, and press the **Scroll Wheel/Select** button again. This will bring up the Select Airport QuickSelect dialog window.

You can continue using the **Scroll Wheel/Select** button in this dialog to select a new airport, or press **Reset** to resume flying without making any changes.

The list on the left of the dialog box displays all of the flying sites available to you. If you have created or downloaded any flying sites, those sites will also be visible here.

The flying sites are listed in files and folders in accordance with the software from which they were loaded. For example, if you have installed Expansion Pack 7, the sites from this disc will

be listed alphabetically, beneath the Expansion Pack 7 folder. You can change how the airports are organized, by selecting one of the options under the Grouping drop-down selection box. The options are:

**Product, Scene:** As explained above, airports are first grouped into folders by the product in which they are contained. Within each group, they are then grouped further by scene.

**Product:** Airports are grouped by product alone.

**Scene:** Airports are grouped by scene alone.

**None:** Airports are not grouped into folders at all. Rather, they are listed alphabetically.

Click the **[+] (plus)** or the **[-] (minus)** symbol to reveal or hide the airports within these folders. To select an airport, click on the name of the airport at which you wish to fly.

The rotating image on the right side of the screen provides you with a preview of what to expect at the desired location. The airport information pane below the terrain map contains a description and pertinent information regarding the highlighted airport.

Have some fun while you're in the Select Airport dialog. Using the mouse, click and drag the preview screen to point the camera angle to your choosing. To resume rotating automatically, right-click the preview screen.

When you are satisfied with your selection, click **OK** to return to your flight using the new airport selection. The **Cancel** button will return you to the simulation at the previously selected flying site.

### **Movement Modes-**

If applicable to the respective airports, RealFlight 9's Movement Modes allows you to explore the scenery without an aircraft. Movement is not possible at PhotoField airports.

To select a Movement Mode, press the **'Q'** key on your keyboard. You can press the **'Q'** key repeatedly to cycle through the available modes: Walk, Fly, or Hover.

Walk mode simulates the effect of you, the pilot, physically walking across the field, complete with sound effects. The Fly mode allows you to move through the air and position the camera anywhere that you desire.

Once you have entered the desired Movement Mode, use the **'W'**, **'S'**, **'A'** and **'D'** keys on your keyboard to control the movements. If you wish to increase the speed

of your movement, press and hold the **Shift** key at the same time you are using the **'W', 'S', 'A'** or **'D'** key.

The mouse wheel controls the angle or height at which you traverse the scenery. To increase the altitude, roll the wheel away from you. This is known as the Hover Mode.

You may also control the zoom levels during your travel. Press the **[+] (plus)** key to Zoom In and the **[-] (minus)** key to Zoom Out. The **Backspace** key resets the zoom level to its default value.

## Edit Current Airport...

RealFlight 9 offers unparalleled freedom to edit flying sites. You can add and remove objects, alter their location, rotate, and even modify the physical size of the items. It is also possible to alter the atmospheric or lighting conditions at the various flying locations.

The first several times you access the airport editing function, the possibilities might seem daunting. It will require some getting used to before you are comfortable with this feature and its related functions. The best way to do so is to simply dive in and experiment.

To modify the currently selected flying location, click the **Simulation** menu followed by the **Edit <Current Airport>...** menu item, where <Current Airport> is the name of the airport you have loaded at the moment. This activates RealFlight 9's FlexiField flying site editor, with the currently active airport loaded and ready to edit.



## Airport Editor Menus-

Selecting the Edit Current Airport option activates the screen shown above.

### File Menu-

This menu and its menu items are used to manipulate and control the various folders and related items in the airport editor.



### Open-

This menu item is used to open existing and edited airports. Selecting this menu item opens the Select Airport dialog.

### Save-

This option becomes active once you have renamed and saved the edited airport. Prior to doing so, this option remains inactive and grayed out.

### Save As-

Upon completion of the airport editing, click this menu item to save the modifications. You will be asked to type in a name for this new airport. Once you have renamed the airport, click **OK** to accept the new name. The airport will now appear in the airport listings.

### Save folder-

This option allows you to select an entire sub-folder in an airport and save it as a new file. For example, it is possible to select the entire “Objects” sub-folder in RealFlight Ranch and save it on a disc.

To save a folder, highlight it, click on the File menu and select **Save Folder**.

Alternatively, you can right click on the existing folder and select **Save Folder**. This brings forth a dialog that allows you to determine the new folder’s name, as well as the location where it will be saved.

### Load Folder-

This option allows you to load a folder from the saved folders. To do so, first highlight a destination folder, click on the File menu and select **Load Folder**.

### Exit to Simulator-

Use this option to close the Airport Editor and return to the simulation. If you have not made any changes to the airport, you will return directly to the simulation. If you have unsaved changes, a message box will ask for confirmation before returning to the simulation.

### Edit Menu-

This menu may be used for some simple editing functions in the selected airport.





### **Undo-**

Select this to undo the last change you made in the airport editor.

### **Redo-**

Choose “Redo” to repeat the last action you undid with the “Undo” command.

### **Cut-**

Select one or more objects at the airport and choose “Cut” to remove the selected objects. The objects are stored temporarily in RealFlight’s memory and can be pasted back into an airport.

### **Copy-**

Like the Cut option, “Copy”, will store the selected objects in RealFlight’s memory allowing you to later paste it into an airport. Unlike Cut, the selected object will remain at the current airport.

### **Paste-**

If any objects have been cut or copied, choose “Paste” to add them to the current airport.

### **Delete-**

“Delete” will remove the selected objects from the airport without copying them to RealFlight’s memory. They cannot be retrieved later.

### **Select All-**

This menu option will select all objects at the airport you are currently editing.

### **Deselect-**

Choosing this menu option will deselect any airport objects that might be selected at the moment. If no objects are selected, “Deselect” will remain grayed out.

### **Previous Object-**

If any airport object is currently selected, choosing “Previous Object” will select the preceding object in the folder list.

### **Next Object-**

If any airport object is currently selected, choosing “Next Object” will select the next object in the folder list.

### Select Parent-

All objects belong to a group or parent. To select the parent that the current selected object belongs to, choose “Select Parent”.

### Select Child-

If a group is currently selected, choose “Select Child” to select the first object listed in that group.

### Set As Default Pilot Spawn-

Choose a pilot spawn and click this menu option to set it to the default spawning point. This point will be the default camera position each time you load the current airport.

### View menu-

This menu allows you to modify your view of the airport while editing it.



### Mode-

The Mode menu is utilized to alter the camera perspective when viewing the scene. There are four distinct view modes in RealFlight 9: Fly Camera, Pan Camera, Pivot Camera and Normal Camera. These modes, as well as the methods to access them, will be discussed in depth in the sections that follow.

### Fly Camera-

The Fly Camera option allows the camera to function just like the Movement Mode in the simulation. See page 155 for more details.

There are several ways to access the Fly Camera mode. The first, and probably the easiest, is to press the 'V' key on your keyboard. You may also right click on the scene and select Fly Camera from the menu box that appears. The final method is to select Fly Camera through the View menu and Mode sub-menu item.

To exit the Fly Camera feature, right click in the editing view and select the desired option from the menu box that appears. You can also exit this mode by hitting the 'Z' key, which returns you to the normal viewing mode.

### Pan Camera-

The Pan Camera option allows the camera to shift the vantage point on the selected scenery.

There are several ways to access the Pan Camera mode. The first, and probably the easiest, is to press the 'C' key on your keyboard. You may also right click on the scene and select Pan Camera from the menu box that appears. The final method is to select Pan Camera through the View menu and Mode sub-menu item.

To exit the Pan Camera feature, right click in the editing view and select the desired option from the menu box that appears. You can also exit this mode by hitting the 'Z' key, which returns you to the normal viewing mode.

### Pivot Camera-

The Pivot Camera mode pivots or rotates the camera around a particular object or location.

There are several ways to access the Pivot Camera mode. The first, and probably the easiest, is to press the 'X' key on your keyboard. You can also right click on the scene and select Pivot Camera from the menu box that appears. The final method that may be used is to select Pivot Camera View menu in the Mode menu item.

To exit the Pivot Camera feature, right click in the editing view and select the desired option from the menu box that appears. You can also exit this mode by hitting the 'Z' key, which returns you to the normal viewing mode.

### Normal Camera-

This mode returns the camera to its normal, or default perspective.

There are several ways to access the Normal Camera mode. The easiest, is to simply press the 'Z' key on the keyboard. Alternatively, you can right click in the editing view and select Normal Camera from the menu box that appears. Finally, you may select Normal Camera through the View menu and Mode menu item.

### Center View on Selection-

This option centers the vantage point on a particular object. This is useful for repositioning, changing object sizes, rotating, etc.

If you have not selected an object from the Folder Listing, or highlighted an object in the scene, this option will remain inactive or grayed out. If, however, you have made a selection or highlighted an object, there are several ways to select the Center View on Selection option.

Simply right click on the selected object or folder in the Folder Listing and select Center View on Object. Alternatively, in the scene, right click on the highlighted object and select the Center View on Selection from the options listed. The final option is to use the View menu and select the "Center View on Selection" option.

### Fit Selection in View-

This option is utilized to ensure that your selection fits in the view. For example, if your zoom magnification is at an extremely high level, the object may not completely fit on the screen. This feature ensures that it will.

To access the Fit Selection In View, right click on the highlighted object in the scene and select the Fit Selection In View from the options listed. You can also use the View menu and select the Fit Selection In View option. Alternatively, press the '0' (zero) key on the keyboard.

### Zoom In-

Click this menu item to magnify or zoom in on the selected item. Alternatively, you may magnify the view or zoom in on the selected item by pressing the **[+] (plus)** key on the keyboard. Each time you press the **[+] (plus)** key or select the **Zoom In** menu item, the zoom level increases incrementally.

### Zoom Out-

Click this item to reduce the magnification, or zoom out of the current view. Alternatively, press the **[-] (minus)** key on the keyboard. You may zoom out via RealFlight 9's menu. Each time the **[-] (minus)** key or the **Zoom Out** menu item is pressed or selected, the view will decrease incrementally.

### Zoom Reset-

This menu item resets the view to the default magnification. Alternatively, you may also press the **Backspace** on the keyboard to reset the zoom to its default value.

### Options Menu-

The Options menu allows you to adjust the behavior of many of the airport editor's functions.



### Selectable Items-

The Selectable Items menu determines whether a particular type of object may be clicked and selected on-screen.

To toggle the ability to select a particular type of item, simply mouse click on the desired listing in the pull-down menu. This is useful when there are many objects clustered in a small area and you want to select just one of them. For example, suppose that an airport has a tight cluster of trees with a dirt pile in the middle and you want to select the dirt pile, it may be easier to first, turn off the tree selection.

This will allow you to easily select the dirt pile without the trees interfering with the selection.

There are three selections available: Objects, Overlays and Trees. Objects includes items such as the structures, fences, vehicles, tents and so forth. Overlays are, as the name suggests, the items that are placed over the scenery such as the runways, etc.

The easiest and simplest way to determine which grouping an item belongs to is to simply toggle the Selectable Items off (no tick-mark next to a selection) and then attempt to choose a particular object. If it allows selection, the object did not belong to the Selectable Items type that was disabled.

### **Add Object Grouping-**

The items available for addition in RealFlight 9 are all grouped or organized accordingly. This menu item determines the way they are grouped in the Object Palette window.

#### **Product, Type, Name-**

Selecting this option causes the objects in the Object Palette to be displayed by the Product, then by the Type, and finally by the Name. That is, objects are first listed within the product in which they appear (e.g., RealFlight 9, Expansion Packs, etc.). Within the product, the objects are then classified by Type (e.g., Buildings, Trees, etc.). Once you've selected the Product and Type of object that is desired, the objects are then listed alphabetically by Name.

For information on adding objects and how to use the Object Palette, please refer to the Object Palette section of this manual.

#### **Type, Name-**

This option causes the objects in the Object Palette to display by the Type and the Name designations only. They are not sorted by the Product in which they appear. Objects that appear in RealFlight 9, Expansion Packs, etc. will be included in one extensive listing.

This option is useful if you are unsure as to which product includes a particular object.

#### **Name-**

Selecting this option causes the objects to be listed in alphabetical order by their name designations (e.g., Barn). This listing is extensive as it includes all of the objects available to you.

This option is useful if you are unsure as to which product contains the object, or if you are unsure as to the type of object that you wish to utilize. It also offers a rapid overview as to the type and number of objects available to you.

### **Rotation Snap-**

When rotating an object on the flying site, you have the ability to control the amount of rotation with the Rotation Snap. There are four snap settings that may be utilized in the editor to provide quick orientation settings for placing objects.

To rotate an object's position on the flying site, follow the procedure mentioned above to select an object. Next, press and hold the Shift key on the keyboard. While holding the Shift key, use the mouse to rotate the object as desired.

#### **None**

The object rotates without any restrictions. This is useful for making minor refinements to object placement.

#### **45 Degrees**

The object will rotate 45 degrees each time this option is selected. This is useful for making large changes to object position.

#### **15 Degrees**

The object will rotate 15 degrees each time this option is selected.

#### **5 Degrees**

The object will rotate 5 degrees each time this option is selected.

### **Display Metric Units-**

Click this item with your mouse to switch the measurement indicators in the Properties pane from SAE (feet, inches, pounds) to metric (meters, centimeters, kilograms). Please note that the unit of measure selection in this menu will also be reflected elsewhere in the simulation (e.g., aircraft specifications, etc.).

## Window Menu-

This menu item activates or eliminates items from the display or window. For example, if you were to click the Properties item in the pull-down menu, this would eliminate the Properties window from the screen.



## Folder Listing-

This listing includes all of the folders available in the airport editor. Selecting this item from the pull-down menu will toggle the presence of the Folder Listing dialog.

## Object Palette-

The Object Palette includes the complete selection of objects available in editing an airport. Selecting this item from the pull-down menu will toggle the presence of the Object Palette dialog.

## Pilot Preview-

Selecting this item from the pull-down menu will toggle the presence of the Pilot Preview dialog.

## Properties-

Selecting this item from the pull-down menu will toggle the presence of the Properties dialog.



## Reset Window Positions-

This menu item resets the positions of the airport editing windows back to their default locations. Additionally, if you have removed any of the default windows, they will return to the screen at this time.

## Utilizing the Editor

Opening the airport editor reveals four distinct windows. For the purpose of clarity, we will examine each window individually. It is, however, important to note that these windows interact with one another.

## Folder Listing Window-

The Folder Listing window consists of the folders and items (objects) that comprise the currently selected airport.

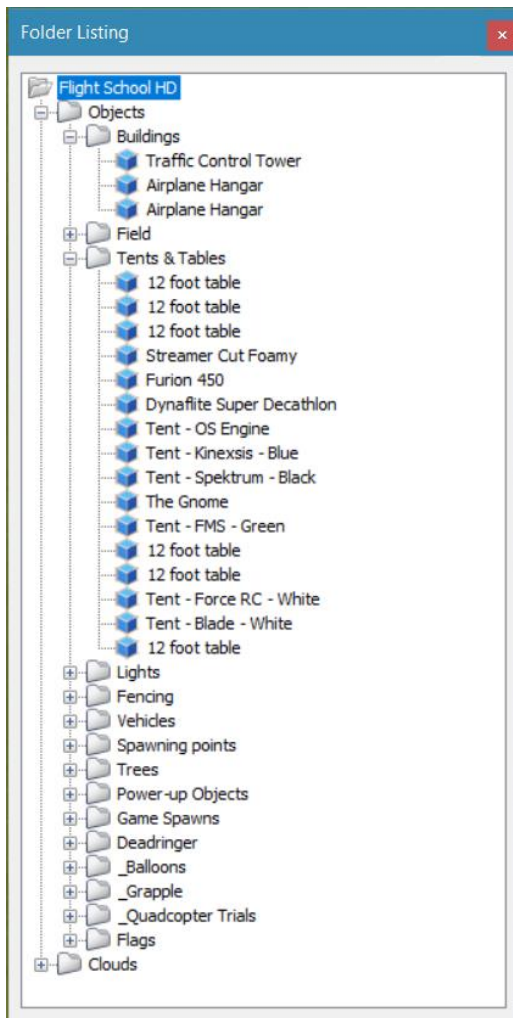

To determine what items are contained within the Objects and Clouds folders, click on the **[+] (plus)** or double-click on the name itself (e.g., Objects). Doing so brings up the various objects and sub-folders that are contained within the folder.

As denoted by the **[+] (plus)** symbols, these folders, in turn, also have another level. Again, to open these respective levels, click on the **[+] (plus)** icon or double-click the folder name.

Alternatively, clicking on an object in the scene will highlight the respective object. It will also open the folder that contains the object. The converse is also true; clicking the folder or object in the Folder Listing menu will highlight the respective item as well.

If you wish to move an object from one folder to another, mouse click and hold the object to be moved. Next, drag the object to the desired location (folder) using the mouse and release. The object will be listed at the bottom of the folder.

Please note: This action removes the object from the original folder.

You may use either of two methods to delete an object from the folder. First, you can highlight the object or sub-folder in the Folder Listing and press the **Delete** key on the keyboard. Second, with the object or sub-folder highlighted, right click and select the **Delete Object** pull-down option.

## Properties Window-

The Properties window indicates the detailed information for the item highlighted in the Airport Editor window. The contents of the Properties window may vary depending upon the selection in the Folder Listing window.

The example below indicates what is displayed if the flying site's root or top-level folder is highlighted. Regardless of what is selected, the Properties are all very similar in nature and in their method of modification.

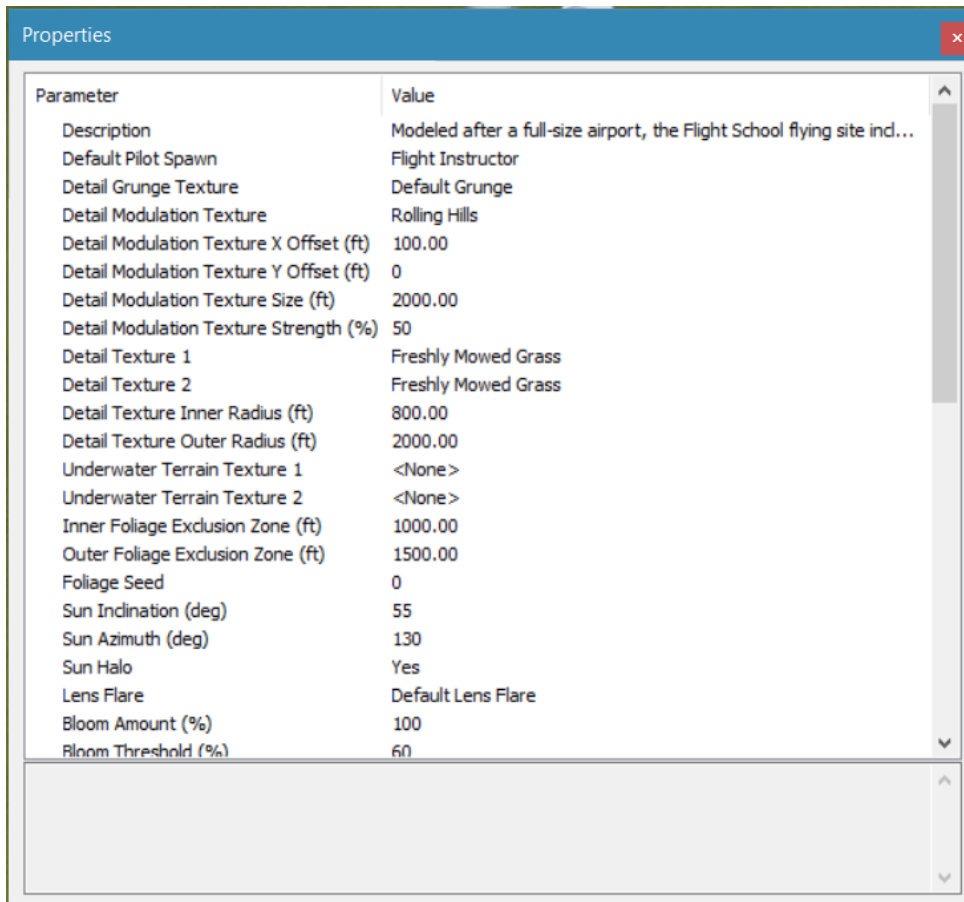

The screenshot shows a window titled "Properties" with a close button in the top right corner. The window contains a table with two columns: "Parameter" and "Value". The table lists various settings for a flying site, including descriptions, spawn points, textures, modulation settings, exclusion zones, and lighting parameters.

Parameter	Value
Description	Modeled after a full-size airport, the Flight School flying site incl...
Default Pilot Spawn	Flight Instructor
Detail Grunge Texture	Default Grunge
Detail Modulation Texture	Rolling Hills
Detail Modulation Texture X Offset (ft)	100.00
Detail Modulation Texture Y Offset (ft)	0
Detail Modulation Texture Size (ft)	2000.00
Detail Modulation Texture Strength (%)	50
Detail Texture 1	Freshly Mowed Grass
Detail Texture 2	Freshly Mowed Grass
Detail Texture Inner Radius (ft)	800.00
Detail Texture Outer Radius (ft)	2000.00
Underwater Terrain Texture 1	<None>
Underwater Terrain Texture 2	<None>
Inner Foliage Exclusion Zone (ft)	1000.00
Outer Foliage Exclusion Zone (ft)	1500.00
Foliage Seed	0
Sun Inclination (deg)	55
Sun Azimuth (deg)	130
Sun Halo	Yes
Lens Flare	Default Lens Flare
Bloom Amount (%)	100
Bloom Threshold (%)	60

If an item has been modified, an icon will appear to the left of the Parameter name. Right clicking the either the Parameter or the Value associated with an item will bring up the Restore Original Value, Set to Default Value or Apply To options. The Apply To option is only applicable to the items that relate to the aircraft spawn items or items that have siblings associated with them accordingly.

## Object Palette Window-

The Object Palette window is used to add a new object or objects to the airport. The object window consists of two separate sections: the preview box in the top section of the window, and the objects list in the bottom section.

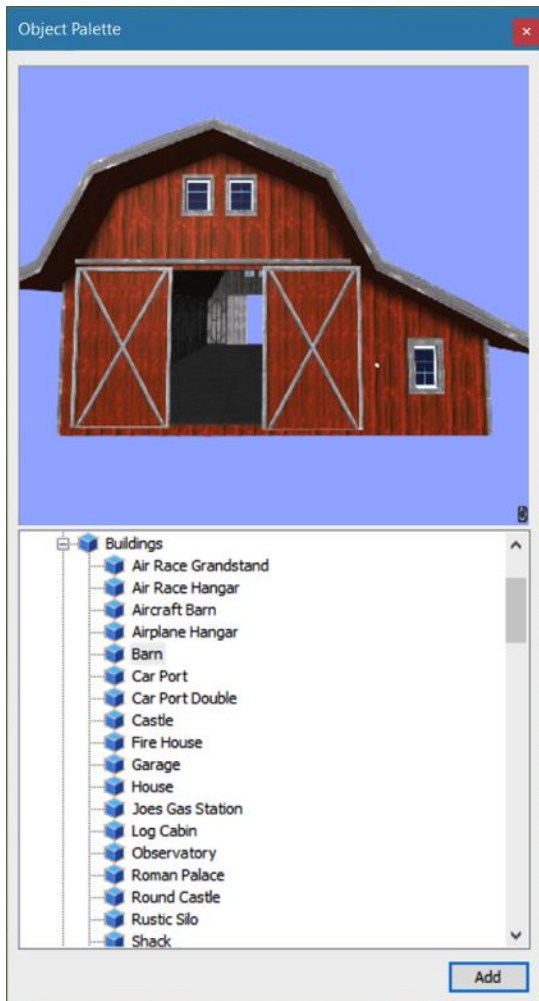

All objects are grouped according to their root directory. Within the root directory, the grouping is further refined. For example, you will find all available benches in the Benches, Chairs, and Tables group. This, of course, assumes that you are utilizing the Product, Type, or Name as determined by the Add Object Grouping Selection in the Options menu.

Each object group is preceded with a [+] (plus) and an icon. The [+] (plus) indicates that there is another expansion level, or selection, available to you. Clicking on the [+] (plus) or double-clicking the respective root directory name (e.g., RealFlight 9) will bring forward the pull-down menu of the items contained within the specified folder.

For example, if you wanted to add a bench to the current airport, take the following steps:

1. Click on the **[+] (plus)** icon in front of the Benches, Chairs and Tables group (or, double-click the group name itself). This reveals the next expansion level.
2. From the expansion list, select the **'Bench'** object. The selected object appears in the preview box.
3. Click the **Add** button, which adds the object to the scene.

You will find additional information pertaining to object placement, positioning, etc., in the Properties section of this chapter, which follows.

You may use several available methods to change the location of an object in the airport. To use the drag and drop method, click on the object to select. Once you have highlighted the object, press and hold the mouse button. Move the mouse to the desired location, then release the button to drop the object in the new location.

With the object highlighted, right click the mouse elsewhere in the scenery. This brings up a pop-up menu with several options. To move the selected object, point the mouse to the location that you desire and click the **Move Here** option.

RealFlight 9 also allows you to easily replicate the selected objects. To do so, hold the 'Ctrl' key down, click and hold the mouse button and use the mouse to drag the object to a new location. You will see that the original object stays in place. Release the mouse button and the 'Ctrl' key to drop the new item in place.

Once you have added an object to the airport, you can modify it freely. Refer to the Properties Window – Object Selection section for information on how to do so.

## Pilot Preview-

This window provides you with the ability to view the scene from the pilot's perspective. It is very useful when editing PhotoField airports.



The number of pilot perspectives available varies dependent upon the selected scene. For example, RealFlight Ranch offers: Runway Center, Runway End and Helipad as the viewing options. To select from these options, open the Control Objects in the Folder Listing. Use the up/down arrow keys on the keyboard or the mouse to select the desired perspective.

It is also possible to modify the selected vantage points. For example, you may Zoom In and Out, or simply scan the horizon. Note that in order to modify the vantage point, the Pilot Preview window must be the active window. To ensure that the Pilot Preview window is the active window, simply click on, or in, this window.

To zoom in, press the **[+] (plus)** key on the keyboard. To or zoom out, press the **[-] (minus)** key on the keyboard.

In most cases, you can also use the scroll wheel on the mouse to zoom in and out on the scenery.

RealFlight also allows you to scan the scene. To do so, press and hold the mouse button. Moving the mouse will shift the scenery.

## Create New Airport

This menu enables you to create an entirely new airport, starting with a fresh canvas. The FlexiField™ flying site editor provides you with virtually unlimited editing options, limited only by your imagination.

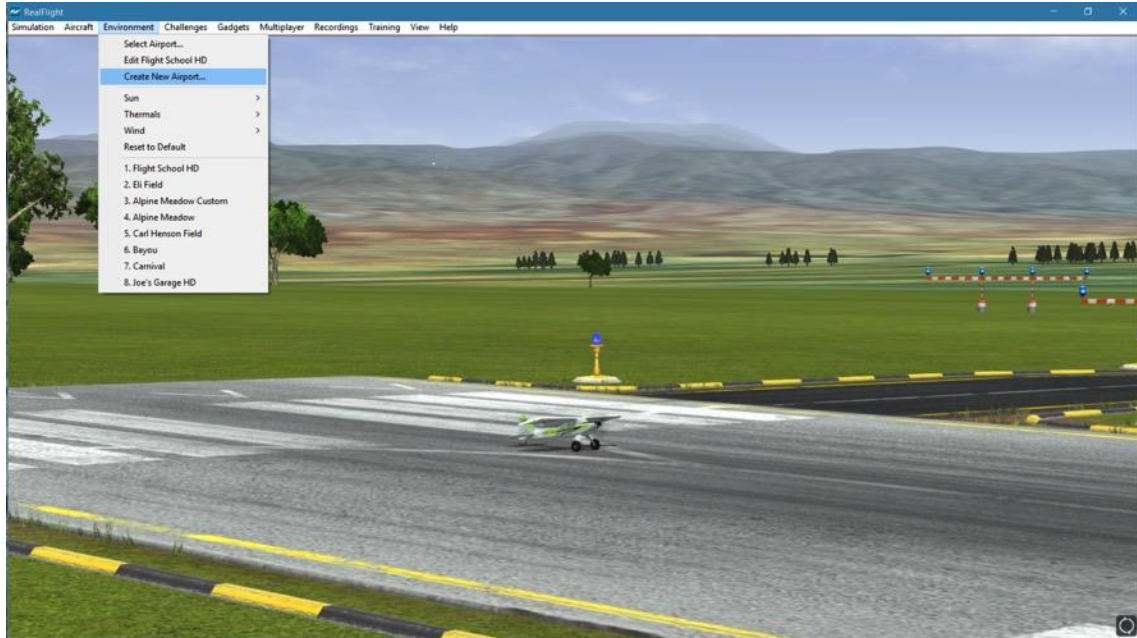

The options available to you when creating an airport are identical to those found in the section pertaining to the airport editor described previously. As such, we will avoid duplicating these instructions. Instead, we encourage you to experiment with the options, settings, and choices as you see fit.

After you have finished creating your airport, click the **File** menu and save the airport. The airport name will appear in your Custom Airports folder in the RealFlight 9 directory.

## Sun-

RealFlight 9 gives you the ability to adjust the position of the sun in the sky. By changing the Azimuth, you can rotate the sun around. Change the Inclination to adjust how high in the sky the sun should be, or turn day into night by moving the sun below the horizon.



Please note, the sun settings are not applicable at PhotoField flying sites.



## Adjusting the Sun Azimuth-

If you customize an airport and find that the sun is always in your flight path, adjusting the sun's azimuth is a good way to move it around the out of your way.

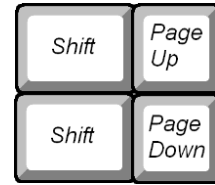

To adjust the azimuth, select the **Sun** menu. This will bring forth the Azimuth and Inclination options. Highlight the **Azimuth** menu item in the pull-down selections. To rotate the sun to the right, click **Increase**. Clicking **Decrease** will rotate the sun to the left.

When altering the azimuth, the simulation temporarily displays the new location in the lower left corner of the window.



## Adjusting the Sun Inclination-

To position the sun higher in the sky, or set it below the horizon, modify the inclination.

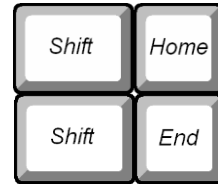

To adjust the inclination, select the **Sun** menu. This will bring forth the Azimuth and Inclination options. Highlight the **Inclination** menu item in the pull-down selections. To raise the sun higher in the sky, click **Increase**. Click **Decrease** to lower the sun, or to set it below the horizon to make it night time.

When altering the inclination, the simulation temporarily displays the new location in the lower left corner of the window.

At night time, RealFlight 9 will automatically enable lighting effects on the objects and aircraft that offer the lighting abilities.



## Thermals-

Thermals add to the realism in the RealFlight environment. A thermal is a column of rising air that is hotter than the surrounding air. Thermals affect all aircraft, but they are most important to gliders and soaring aircraft, as thermals assist them in obtaining additional altitude and potentially increasing flight duration.



RealFlight 9 offers two types of thermals.

### Dynamic-

Dynamic thermals are most realistic. These thermals can appear anywhere in the environment, just as they would in the real world. The simulation will automatically generate thermals when the Dynamic setting is selected.

### Simple-

Unlike dynamic thermals, these type of thermals are static or stationary and do not move around the environment. Only the thermals that were designed into the airport are active.

## Wind-

RealFlight 9's TruFlo Wind Dynamics offers an incredibly realistic wind model. Its components work together to capture this complex, ever-changing force with unbelievable realism. Just as it would at the field, your model will encounter a variety of wind forces as it soars across the skies in RealFlight. Sailplane enthusiasts will appreciate the lifelike effect of the winds as they follow the drafts on the slopes and hills of RealFlight 9.

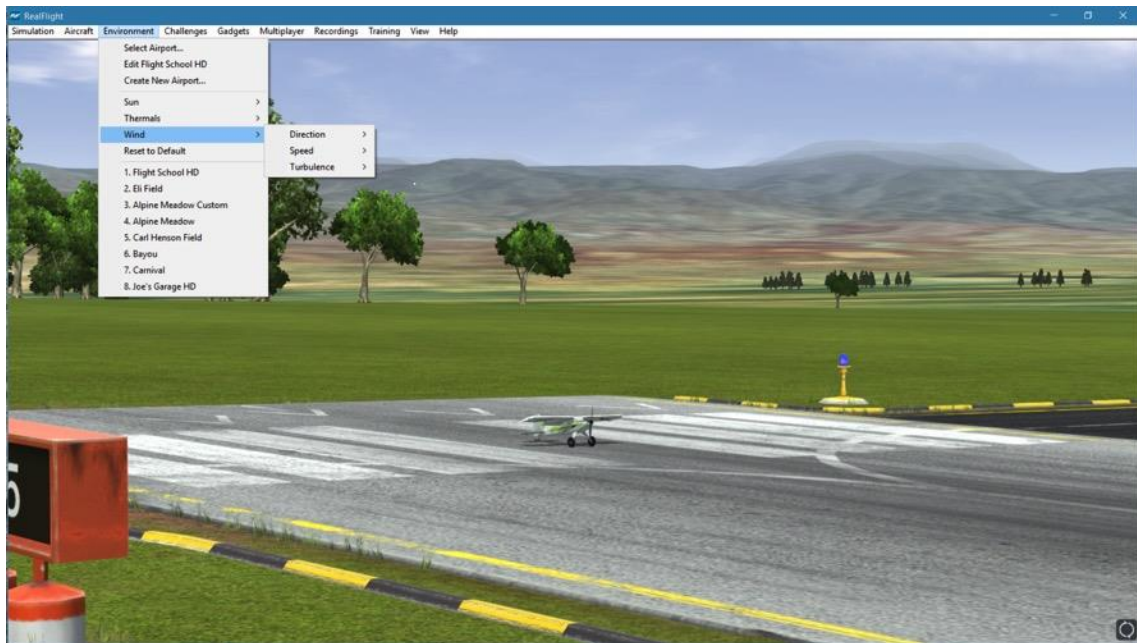

RealFlight offers you the ability to adjust the speed, direction, and turbulence of the wind. To access the Wind settings, click on the **Environment** menu, followed by the **Wind** menu item. Several methods may be utilized to adjust the wind speed and direction.

Home

## Adjusting the Wind Direction-

End

RealFlight 9 allows you to alter the direction (expressed in degrees) of the wind. This function is perfect for practicing crosswind landings.

Selecting the **Wind** menu item brings up the Speed, Direction, and Turbulence options. To adjust the wind direction, highlight the **Direction** menu item in the drop-down selections. To increase the degree of wind direction, click on the **Increase** option in the drop-down selections. Likewise, clicking the **Decrease** option lowers the degree of wind direction. The wind direction degree increases and decreases in 15-degree increments.

When altering the wind direction, the simulation temporarily displays the new wind direction, in degrees, in the lower left corner of the window.

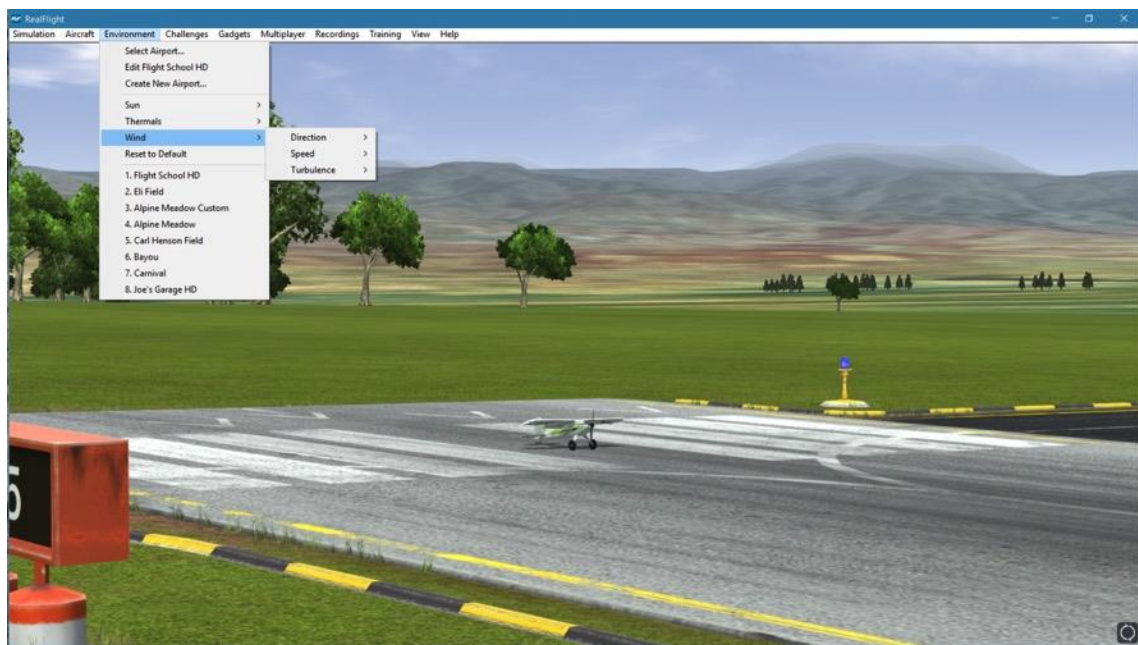

Page  
Up

Page  
Down

## Adjusting the Wind Speed-

Increasing the wind speed is an ideal way to learn to fly in less-than-perfect wind conditions that frequently occur at an RC field. To adjust the speed of the wind, select the **Wind** menu. To adjust the speed of the wind, highlight the **Speed** menu item in the pull-down selections. To increase the speed of the wind, click on the **Increase** option in the pull-down selections. Clicking the **Decrease** option reduces the wind speed.

When altering the wind speed, the simulation temporarily displays the new wind speed in the lower left corner of the window.



Insert

Delete

## Adjusting the Turbulence-

Increasing the turbulence is another ideal method for learning to fly in challenging conditions. Modelers and full-scale pilots alike will all agree that winds are not constant. This setting accurately reflects the lifelike effects of turbulence.

To adjust the turbulence, select the **Wind** menu, and highlight the **Turbulence** menu item in the pull-down selections. To increase the speed of the turbulence, click on the **Increase** option in the pull-down selections. Clicking the **Decrease** option reduces the turbulence.

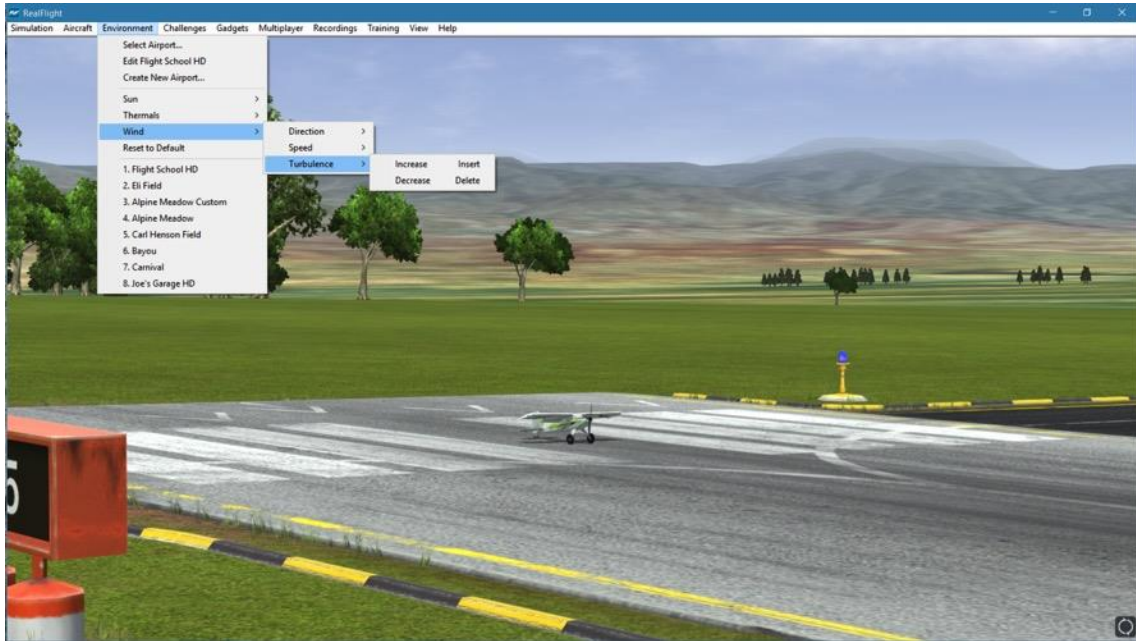

## Reset to Default

Selecting **Reset to Default** will adjust all weather and environment parameters back to their default settings for the currently selected flying site.





## Airport MRU

If you have previously selected an alternative flying location, or locations, you will note that it will appear on a list in the Simulation menu. This list is at the very bottom of the menu and is commonly referred to as a Most Recently Used, or MRU list. It is limited to the eight most recently selected locations. If you wish to fly at one of these locations, simply click on the respective location and it will begin loading.



# Challenges Menu

**TEST AND IMPROVE YOUR FLYING SKILLS WITH EXCITING PILOT CHALLENGES.**

**T**he Challenges menu allows you to practice and improve your flying skills while adding some excitement and fun along the way. There are a variety of challenges available with rewards that unlock as you complete more difficult levels.

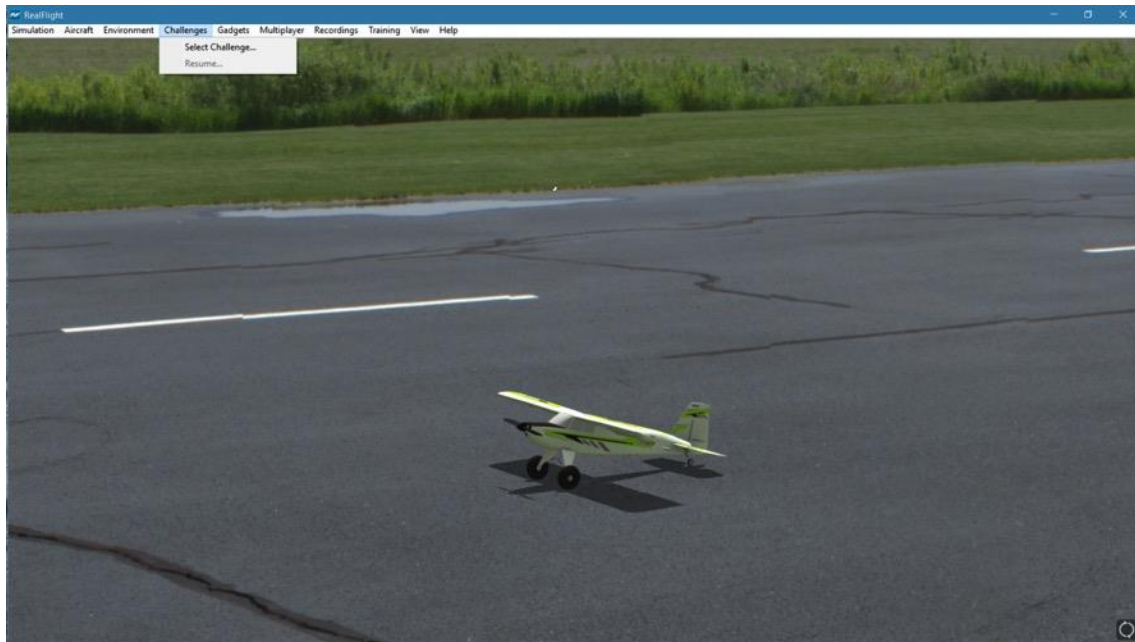

Clicking **Select Challenges** menu item will display the following screen:

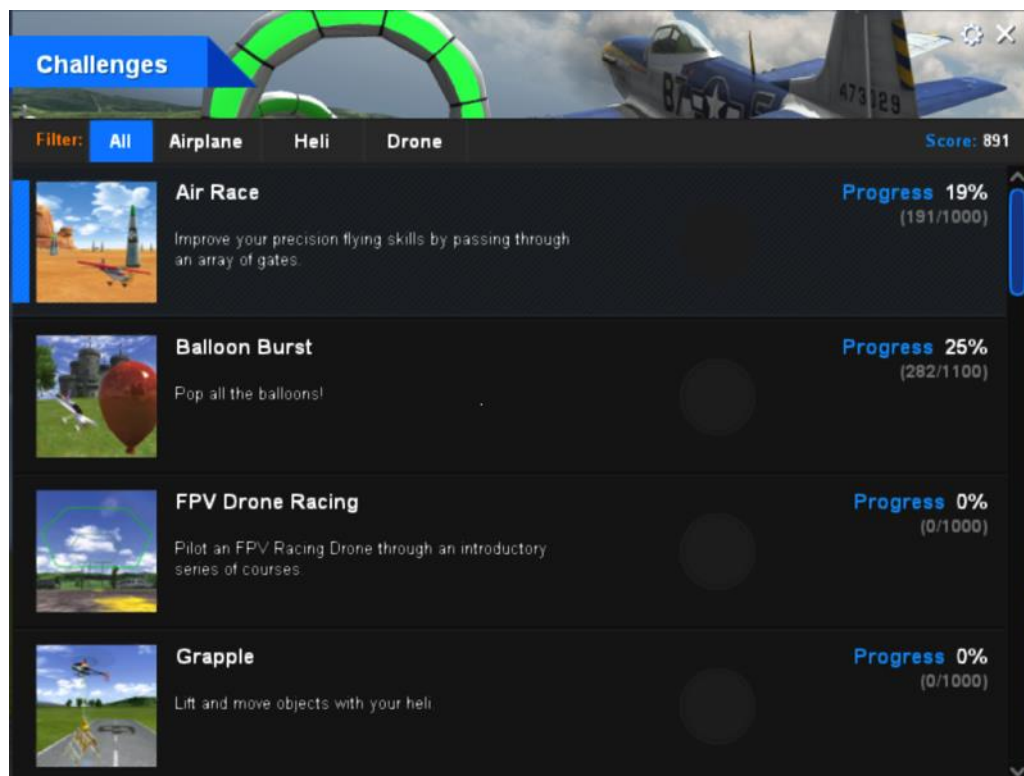

A number of options are available to you from this screen. The most obvious is the list of the different types of challenges available (Air Race, Balloon Burst, etc.). Displayed with each Challenge are any medals that you might have won, along with your progress.

Along the top, you will see your current score tally for Airplanes, Helis, and Drones as well as a cumulative total.

#### *Filter-*

Along the header are the filter options for the challenge list. If, for example, you wish to view only the challenges that require flying a helicopter, click **Heli** in the Filter section. Similarly, if you wish to focus on the Drone challenges, simply click on the Drone tab accordingly.

#### *Settings/Ghost Run-*

Once you have completed 10 levels of any Challenges, you are then allowed to compete against your best times. You'll notice a ghosted image of an aircraft flying through levels you have already completed. This ghosted aircraft represents your best time for that level, giving you something to compete against.

The **gear** icon in the upper right corner of the challenge window gives you the ability to enable or disable the Ghost Run feature. Simply click the gear icon, then check or uncheck the Ghost Run option.

## Air Race

Air Race challenges will put your aerobatic flying skills to the test while timing your proficiency. You will be given any number of gates that you must fly through.

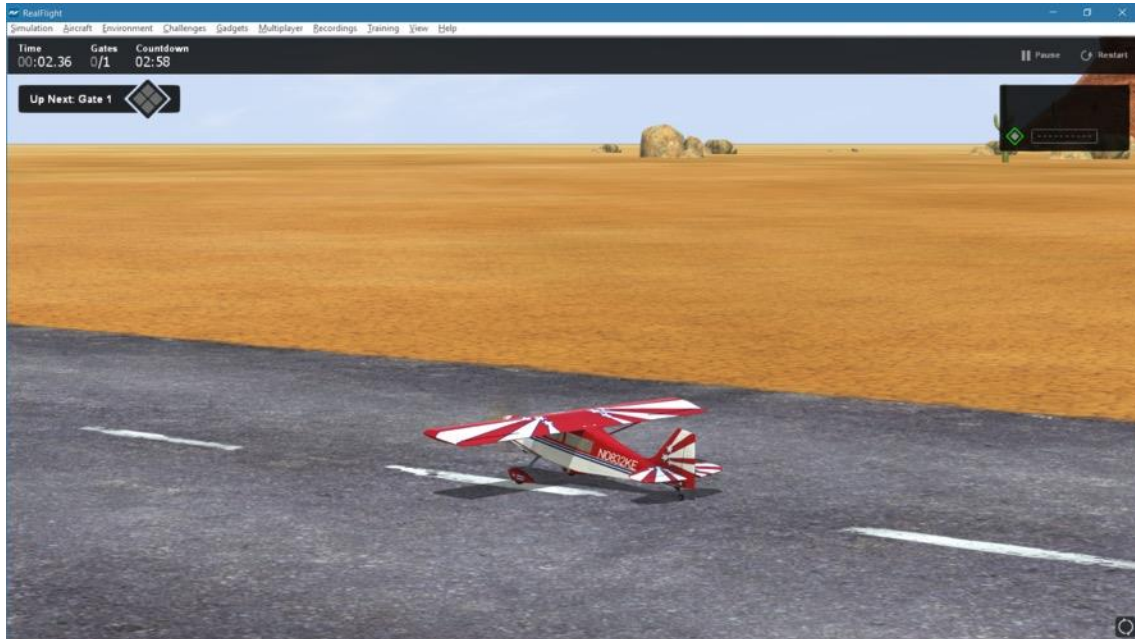

As you improve, the level of difficulty increases. More gates, more aerobatic aircraft, and strict aircraft orientation through the gates will be added. Points are awarded based on the time it takes you to complete the course.

As you complete levels, more levels will become available. Scoring enough points may award you with a new medal, more challenges, or even more aircraft to fly in RealFlight.

## Balloon Burst

Flying from a chase camera, you're required to pop all the balloons at the field. The faster you can do this the more points you will earn.



As more difficult levels become available, you may be required to fly different aircraft or forced to search for hidden balloons.

## FPV Drone Racing / FPV Racing League

Drone racing has gained incredibly popularity in recent years and can even be seen on major television networks. While many modelers won't be able to race at that level of involvement, the simulation offers a drone racing experience for anyone to enjoy.



From the aircraft's point of view, fly through a course of gates. Each level requires quicker reactions from more aerobatic aircraft, on more difficult courses.

Points are awarded by how quickly you can fly through the course.

## Grapple

For those that wish to test their skills at flying rotor aircraft, the Grapple challenges are a must.

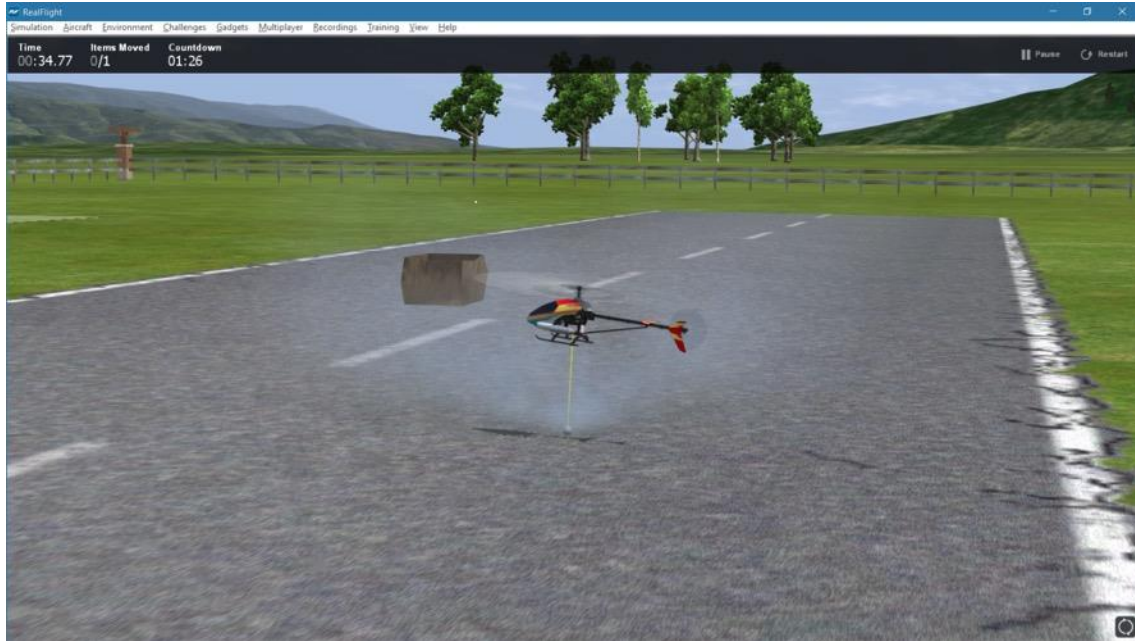

Using the Switch C on the InterLink DX, or channel 5 on your radio, you will be able to pick up objects and release them. Each level will require different tasks for you to perform. Points are awarded based on how quickly you can complete each level.

## Hangar Obstacle Course

Navigate amongst the obstacles in the hangar using Horizon's SAFE technology to stabilize the aircraft. As the levels increase, the number of obstacles increase, also.

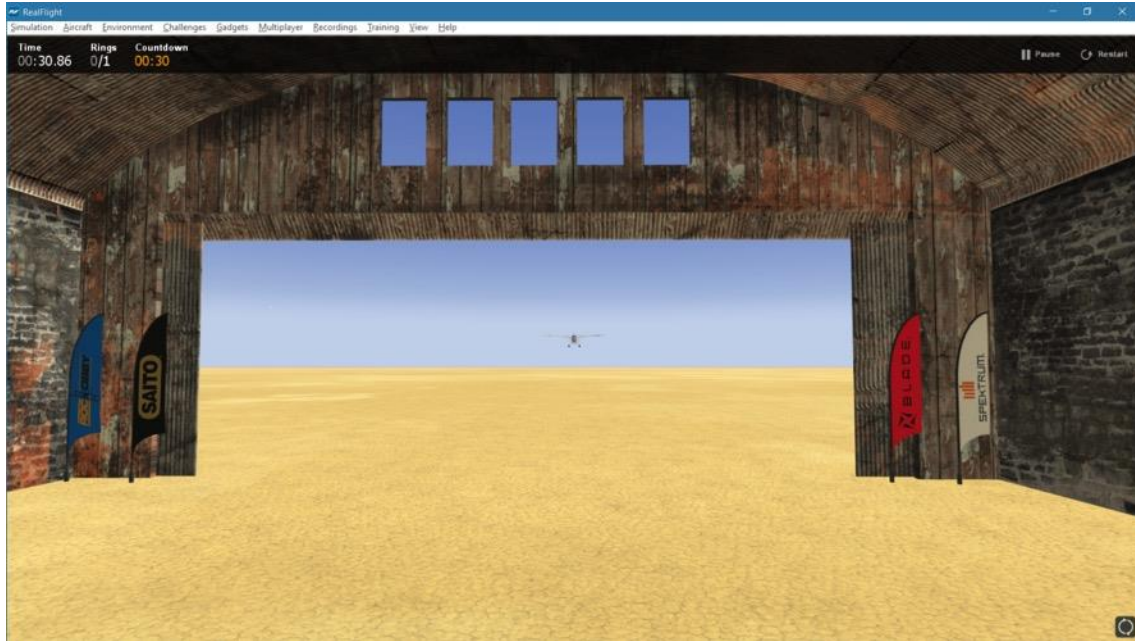

## Limbo

A true pilot isn't recognized until they can prove themselves with high-speed low passes. The Limbo challenges can test who has the guts to get low and fast.

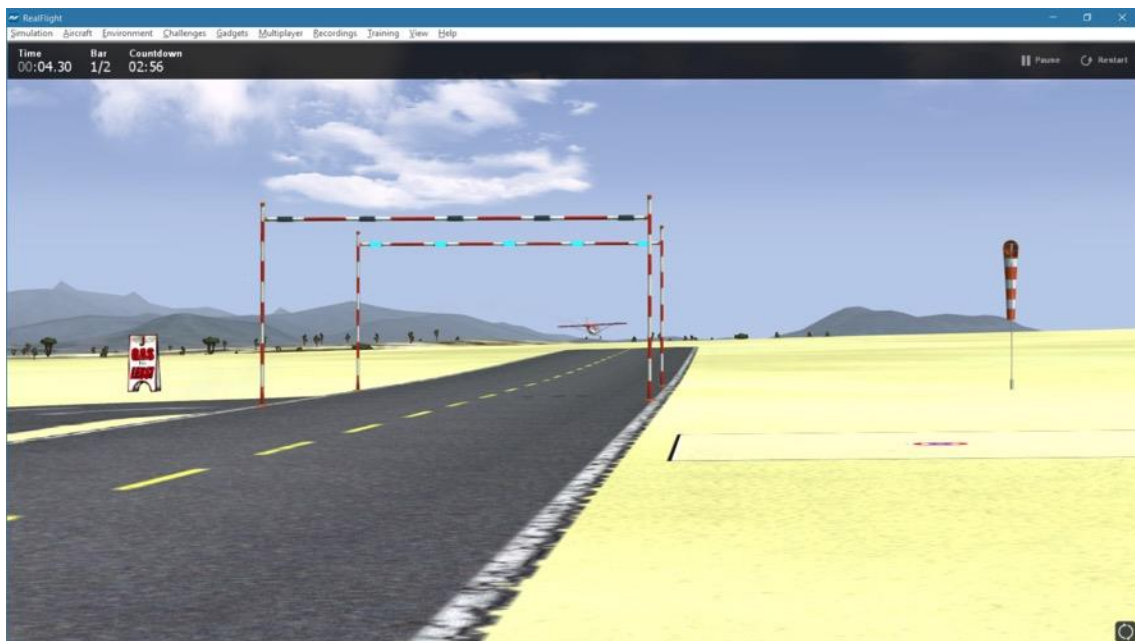



As you progress to more difficult levels, you may find objects in your way, more aerobic aircraft to fly, or even inverted flight requirements. Like many other challenges, points are awarded based on the time it takes to complete each level.

## Quadcopter Trials

You think you have what it takes to fly a Quadcopter? Then the Quadcopter Trials will test your skills.



You'll be walking and following a quadcopter through a number of obstacles. Some you must fly through, while others are platforms you must land on.

Scoring is best on how quickly you can fly through each level. Do well through this challenge, and you'll be rewarded at the end.

## Ring Race

For the real thrill seekers, try jumping into the cockpit and try your hand at Ring Race.

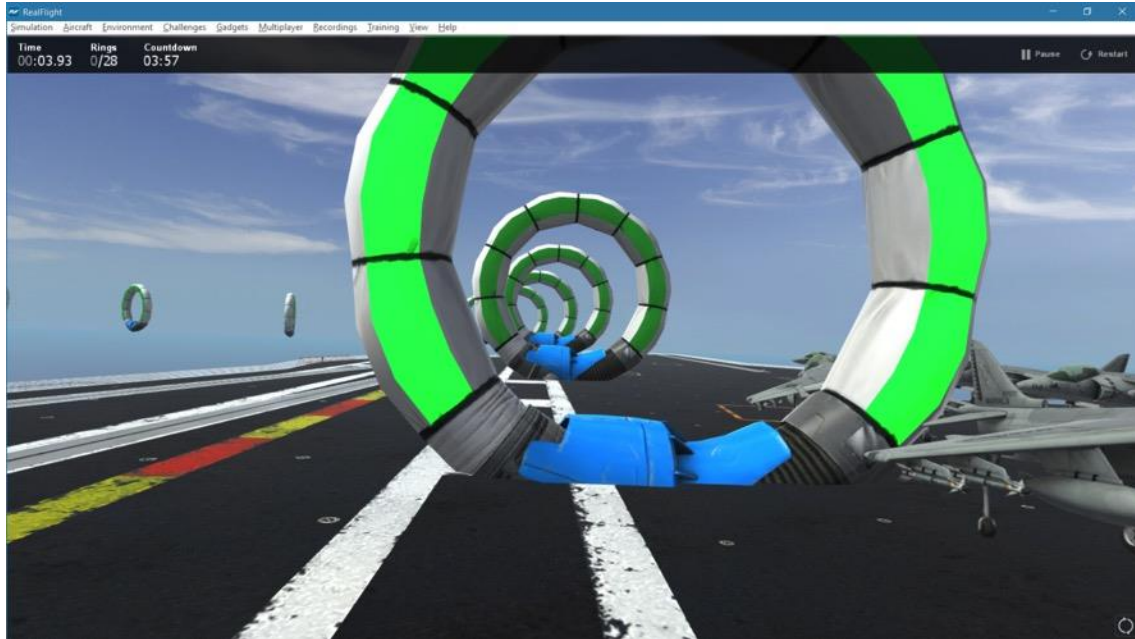

From the aircraft's point of view, fly through a course of rings. Each level requires quicker reactions from more aerobatic aircraft, on more difficult courses.

Like many of the other challenges, points are awarded by how quickly you can fly through the course.

## Scavenger Hunt

Flying multi-rotor aircraft from First Person View has become a popular past time. Now you can try your hand at doing so, and testing your skills at the same time with the Scavenger Hunt Challenge.



With each level, you must locate objects around the flying site that are highlighted in a red box. Fly to them closely, and hold that object inside your targeting circle. Once held there long enough, a picture will be snapped by your on-board camera. At that point, you must find the next object.

Scoring is provided based on how quickly you can find and snap a picture of each object. Try capturing your pictures in different order, finding the best path, to increase your time.

## Spot Landing

As the old saying goes, “Takeoffs are optional, landings are mandatory.” How well can you land?



With the Spot Landing challenge, you must be able to land accurately on a target on the runway. The closer to the center of the target you land the more points you will be awarded.

## Locked Challenges

You will also note that RealFlight 9 includes a number of challenges that are locked and grayed out initially. If/when you complete the existing challenges and have earned enough points/medal to do so, these challenges will unlock accordingly.

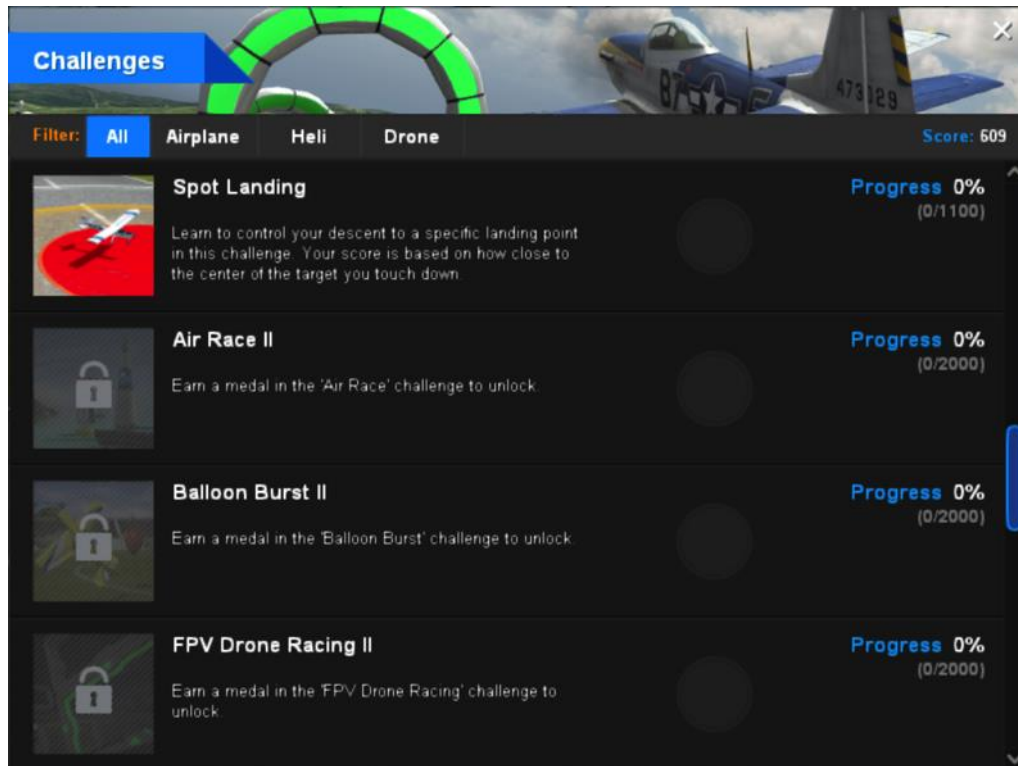

## During Flight

While competing in a challenge, a number of statistics and data are available to you. First, in the upper left corner is information pertinent to the current challenge. For example, this is the area where the event timer is found as well as the remaining time to complete a particular level/challenge. Additionally, an onscreen indicator as to the remaining gates, balloons, etc. may be found in this area, depending upon the challenge selected. If you are participating in an Air Race Challenge, this area will also indicate the number of the next gate through which you must pilot your aircraft.

The right side of the screen also contains information that is useful to challenge participants. The banner contains two icons (and text) that will allow you to:

- Pause – As the name implies, this will pause your flight. Click the **Resume** button that is now visible to continue.
- Restart – Clicking this will return you to the Begin screen where you can view your current high score, description of the current challenge, or return to the level selection screen.

Depending upon the challenge selected, you might also see a ‘map’ indicating visually where the next gate that you must conquer is located.

## Pre-Flight Information

After you've selected a challenge and determined the level that you would like to attempt, a screen similar to the following will appear.

This screen allows you to select an alternative level (Level Select), read the information as to what is to be accomplished within a given challenge (Instructions) and to start your adventure (Begin!).

## Resume Existing Challenge...

If you wish to return to the most recently used challenge (and level), simply click this option.

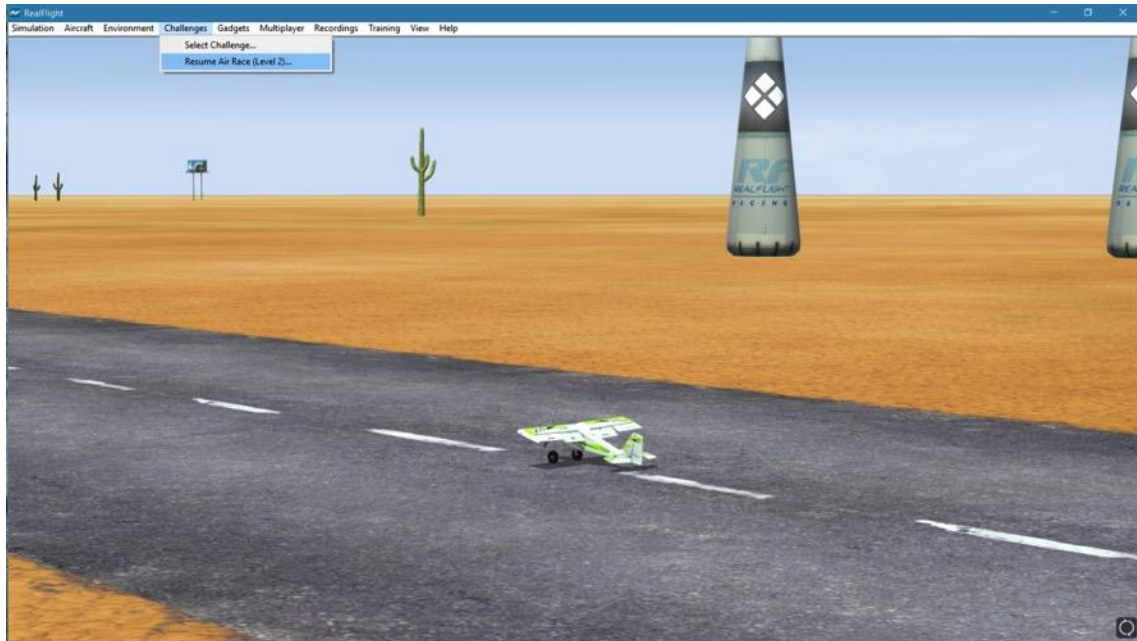

# Gadgets Menu

*THE GADGETS MENU IS USED TO DETERMINE ANY ONSCREEN INDICATORS, AUDIO INDICATORS AND OTHER SUCH GADGETS THAT WILL ASSIST THE PILOT DURING FLIGHT.*

The Gadget menu allows you to select amongst a wide variety of options that you might find useful during flight.

A Gadget is an on-screen display that provides you with information pertaining to a certain aspect of your simulation experience. To access the Gadgets menu item, click the **Gadgets** menu title. This will open the list of available gadgets for the simulation.

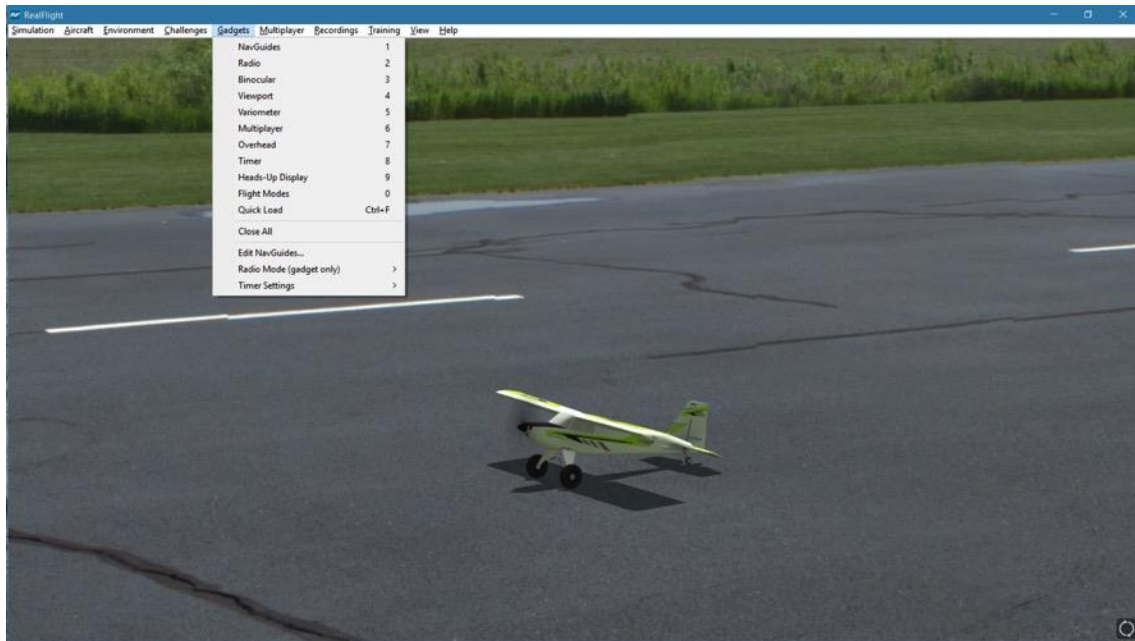



## NavGuides

A NavGuide is an on-screen display that allows you to view some basic information pertaining to your aircraft. If you wish to alter the contents of the NavGuide, please refer to the Edit NavGuides... section later in this chapter.

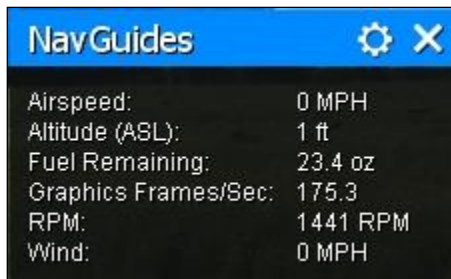

To access the NavGuides, click the **Gadgets** menu title, followed by the **NavGuides** menu item.



You may also load the NavGuides using the InterLink DX with the QuickSelect buttons. Press the **Scroll Wheel/Select** button. Then use the roller to highlight the NavGuides tab. The NavGuides tab looks like an aircraft gauge. Press the **Scroll Wheel/Select** button again to activate the NavGuides. Repeat these steps to remove the NavGuides from the screen.

When the NavGuides are active, an overlay screen will appear on your display. This screen displays the NavGuides information to you.

If you do not wish to view this information, double-click on the **title bar** of the display box. This hides the information. To view it once again, simply double-click the **title bar**.

Clicking the **Gear** icon in the title bar will open the NavGuide settings and options. See page 210 for more information.

Clicking on the **'X'** in the title bar of the frame will remove it from the screen entirely.

Items included by default in the NavGuides are the following:

### Airspeed-

This option displays the airspeed of the aircraft.



**Altitude (ASL)-**

This option displays the altitude for the respective aircraft above sea level. Even though the aircraft may be taxiing on the runway, the altitude may reflect hundreds or thousands of feet, if applicable.

**Battery/Fuel Remaining-**

This indicates of the amount of battery mAh or fuel that remains for your aircraft at a given moment. This value will decrease throughout the longevity of the flight.

**Graphics Frames/Sec-**

This is an abbreviated version of Frames per Second, or FPS. While the data displayed is not relevant to your aircraft, it is used to provide you with feedback on how your computer is performing at any given time. The higher the frames per second, the smoother the simulation will appear.

**RPM-**

This option indicates the current revolutions per minute, or RPM's, for the engine.

**Wind-**

This option displays the current wind speed at the flying site.

## 2 Radio

The on-screen radio display is useful for many facets of flight. For example, when used in conjunction with recordings, this allows you to see real-time control input from the original pilot. Observing the link between controller movements and aircraft performance will advance your knowledge and understanding of a maneuver.



To access the Radio, click the **Gadgets** menu title, followed by the **Radio** menu item.



You may also load the Radio using the InterLink DX with the QuickSelect buttons. Press the **Scroll Wheel/Select** button. Then rotate the scroll wheel until the Radio tab is highlighted. Press the **Scroll Wheel/Select** button again to activate the on-screen Radio. Repeat these steps to remove the Radio from the screen.

If you click the on-screen radio, the entire viewport is displayed, including the title bar.

To resize the viewport, position the cursor over the lower right corner of the viewport's frame. Using the mouse, drag the frame according to your wishes. If you drag it downward,

the vertical size of the viewport will increase. Dragging the frame to the right or left increases or decreases the width of the viewport respectively.

Clicking on the 'X' in the title tab of the frame removes the radio gadget from the screen.

3

## Binocular

The Binocular option will show a perfectly zoomed aircraft, as if you were looking through a pair of binoculars. The background of the viewport box becomes transparent. This provides a visual indicator alerting you that you are using “binocular vision.”



The Binocular option is a great way to see the control surfaces on an aircraft that is too far away to see in the main view. Although not realistic, it does help to see the effects of control input.

By default, the Binocular view will automatically hide when the aircraft is close enough to be seen in the main window. When it does so, the Binocular icon will be visible to indicate that this gadget is still active. The view will reappear when the aircraft flies off into the distance. If you wish for the Binocular view to remain on the screen permanently, simply click the thumbtack button in the gadget's title bar.

To access the Binocular menu item, click the **Gadgets** menu title. Next, click **Binocular**.



You may also load the Binocular viewport using the InterLink DX with the QuickSelect buttons. Press the **Scroll Wheel/Select** button. Then rotate the scroll wheel until the Binocular tab is highlighted. Press the **Scroll Wheel/Select** button again to activate the Binocular viewport. Repeat these steps to remove the Binocular viewport from the screen.

To adjust the size of the viewport, position the cursor over the arrow indication found in the lower right corner of the viewport's frame. Click and hold on the arrow. Using the mouse, drag the frame according to your wishes. If you drag it downward, the vertical size of the viewport will increase. Dragging the frame to the right or left increases or decreases the width of the viewport accordingly.

Clicking on the 'X' in the title tab of the frame removes the frame from the screen.

4

## Viewport

The Viewport menu item allows you to open up a smaller window so you can adjust independently from the main simulator screen. This works much like a picture-in-picture feature found on many TVs.

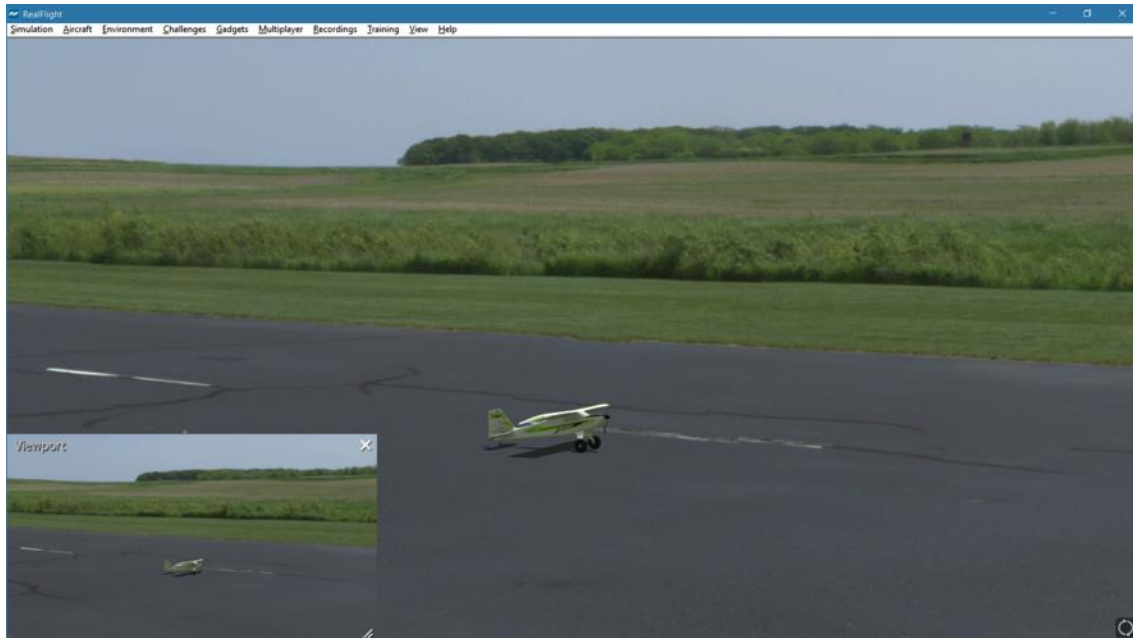

Once you create a new viewport, you can adjust the size or reposition it by dragging with your mouse. You can also fully adjust all the viewport's properties (zoom level, vantage point options, etc.), independent of any properties of the main window.

To access the Viewport menu item, click on the **Gadgets** menu. Then select **Viewport**.



You may also load the Viewport using the InterLink DX with the QuickSelect buttons. Press the **Scroll Wheel/Select** button. Rotate the scroll wheel until the Viewport tab, pictured with a computer monitor, is highlighted. Press the **Scroll Wheel/Select** button again to activate the Viewport. Repeat these steps to remove the Viewport from the screen.

To change the vantage point options and features, use the commands found in the View menu. Ensure that the viewport you wish to modify is the active viewport, or the modifications will not take effect. Alternatively, you may click the left or right arrows that appear at the bottom of the Viewport.

Note that some camera angles are not available at PhotoField airports. The Viewport will display static if these cameras are chosen. Additionally, a Warning will appear within the Viewport noting that this camera selection is not supported. To utilize these camera angles, switch to a flying site that is not a PhotoField.

Clicking on the 'X' in the viewport's title bar removes it from the screen.

5

## Variometer

A variometer is an instrument designed to indicate the rate of climb or descent of an aircraft. The variometer is useful to pilots flying powered aircraft so they can ascertain that level flight is maintained. This is useful during turning maneuvers. Glider pilots typically make the most use of a variometer, to help determine the areas of rising or sinking air currents.



To access the Variometer, click the **Gadgets** menu title, followed by the **Variometer** menu item.

The variometer available in RealFlight also offers an audio indicator, much like the real instrument. As the rate of climb increases, the pitch in the audio tone will increase, as well. The opposite holds true, as the descent of the aircraft increases, the pitch in the audio tone decreases accordingly.

If you wish to turn off the audio queues, click the button with the **speaker symbol** in the lower right corner on the variometer. To turn the audio back on, click the button once again.

The variometer in RealFlight 9 is split into two parts. The left side of the variometer includes a status meter which indicates whether the aircraft is ascending, descending or maintaining level flight. If the bar is in the green, the aircraft is rising. If it is in the red, then the aircraft is descending. If it remains stationary in the middle, the aircraft is maintaining its existing altitude. The farther the bar moves from the center, the faster the rate of change in altitude. On the right, there are three readouts that offer the following information:

- Rate – This indicates the rate of change in altitude.
- ASL – This shows the altitude above sea level.

- AGL – This indicates the altitude above ground level.

Clicking the Variometer viewport will display the title bar and frame. Clicking on the 'X' in the title tab of the frame removes the frame from the screen.

## 6 Multiplayer

This gadget enables the Scoreboard, which offers a wealth of information about all the players connected to the multiplayer session, as well as details on the current game (if one is in progress).

For more information about the Scoreboard, see page 236.

## 7 Overhead

To help you track your location relative to the airport, use the Overhead gadget. This gadget, as the name suggests, gives you an overhead view of the airport with a small airplane picture representing your aircraft.



During multiplayer sessions, the Overhead gadget will show the location of all players. The color of the airplanes will match the color chosen in the Pilot Profile.

Note that the Overhead gadget is not available at PhotoField airports.

8

## Timer

The Timer gadget is a simple stopwatch to offer timing functions. This is especially useful for sailplane pilots that wish to time the duration of their flights.



Clicking the Start/Stop button on the gadget will start and stop the timer. Reset will set the timer back to zero.

You may also change how the timer starts and stop. See *Timer Settings* below for more details.



# 9

## Heads-Up Display

The Heads-Up Display (HUD) projects an FPV (First Person Video) or combat jet-like display over the screen that provides useful data in real time.



Information displayed by location on screen:

- Upper left – Fuel Remaining
- Top center – Heading
- Upper right – Variometer; the rate of climb or descent.
- Left side – Airspeed
- Center – Pitch ladder, showing the aircraft’s pitch and roll in relationship to the horizon.
- Right side – Altitude
- Bottom center – Direction and distance to your starting location.

While the HUD can be displayed at any time, it’s most useful when flying from the cockpit or nose views.

## **Ctrl** Quick Load...

The Quick Load gadget allows you to rapidly search and select a new aircraft or flying site.

**F** Select **Quick Load** from the Gadgets menu, or press 'Ctrl + F' to display the following gadget:

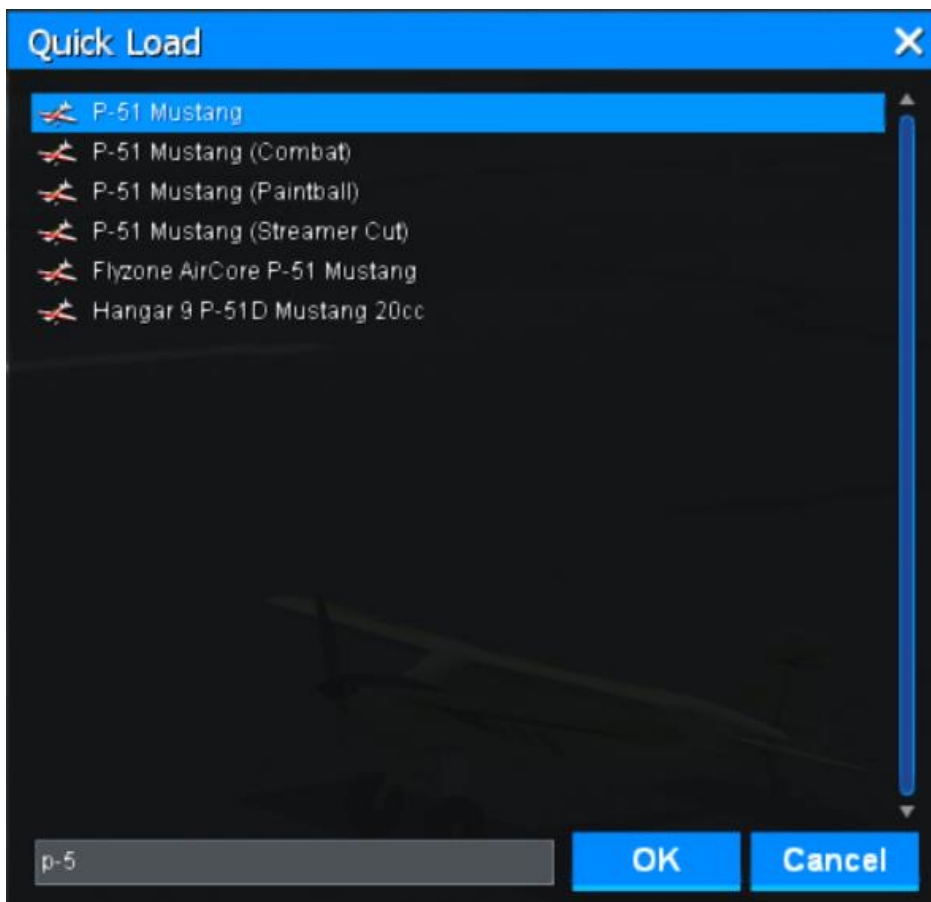

To begin your search, begin typing the name of the aircraft or airport you wish to load. As you type, any aircraft or airport that is installed (including Expansion Packs) that match what you type will begin to appear. The more precise the search word, the narrower the selection of rows available. Select the aircraft or airport you wish to load, and then click **OK**.

## Close All

This menu item closes all open gadgets. It offers the user an easy method to clean up the screen without having to close each gadget separately.

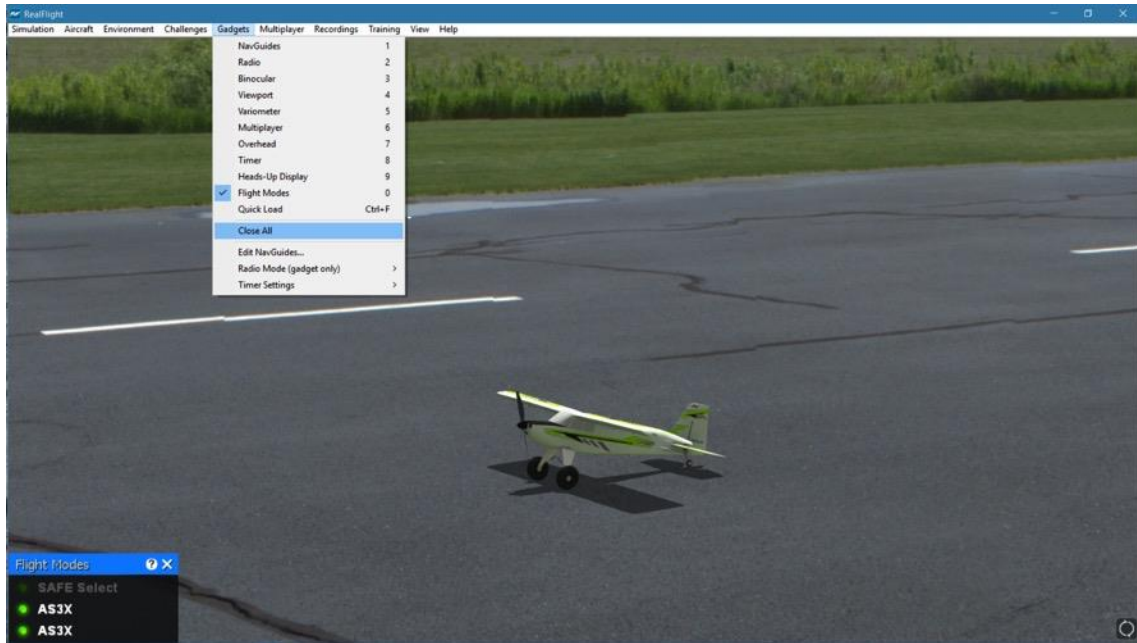

## Edit NavGuides...

This menu item allows you to modify the data and display of the NavGuides box.

To access the Edit NavGuides feature, click the **Gadgets** menu title, followed by the **Edit NavGuides...** menu item. Alternatively, clicking on the 'gear' of the on-screen NavGuides will open the edit screen also.

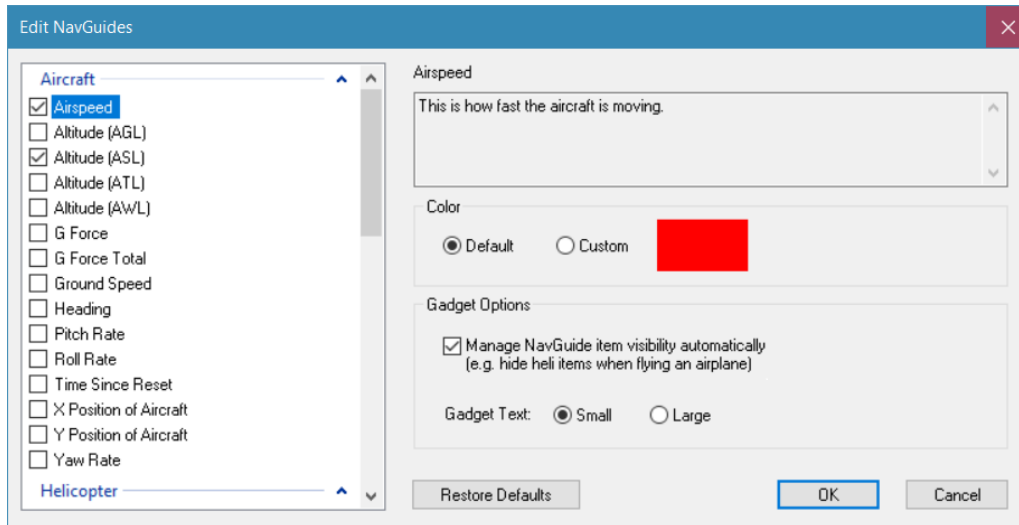

### Modifying the NavGuides-

To add any of the options from the top list to the NavGuides display, click in the checkbox next to the respective item.

The pane below the list of the Edit NavGuides dialog box contains a description of the item when selected or highlighted.

The NavGuides available are listed in the following table:

Option	Description
Aircraft: Airspeed	Check this item to display the current airspeed of the aircraft.
Aircraft: Altitude (AGL)	Check this item to display the current altitude of the aircraft above ground level.
Aircraft: Altitude (ASL)	Check this item to display the current altitude of the aircraft above sea level.
Aircraft: Altitude (ATL)	Check this item to display the current altitude of the aircraft compared to the terrain below. This option does not account for water.
Aircraft: Altitude (AWL)	Check this item to display the current altitude of the aircraft above the body of water at the airport.
Aircraft: G Force	Check this item to display the gravitational load that the

	aircraft is experiencing as felt by the pilot.
Aircraft: G Force Total	Check this item to display the gravitational load that the aircraft is experiencing in any direction.
Aircraft: Ground Speed	Check this item to display the current ground speed of the aircraft.
Aircraft: Heading	Check this item to display the current heading of the aircraft. This heading is displayed in degrees, as they would appear on a compass. "0" degrees is North, "90" degrees is East, "180" degrees is South and "270" degrees is West.
Aircraft: Pitch Rate	Check this item to display the current rate of pitch for the aircraft.
Aircraft: Roll Rate	Check this item to display the current rate of roll for the aircraft.
Aircraft: Time Since Reset	Check this item to display the amount of time that has elapse since the last time the Reset button has been pressed.
Aircraft: X Position of Aircraft	Check this item to display the current X position of the aircraft.
Aircraft: Y Position of Aircraft	Check this item to display the current Y position of the aircraft.
Aircraft: Yaw Rate	Check this item to display the current rate of yaw for the aircraft.
Helicopter: Main Rotor RPM	Check this item to display the current main rotor RPM of the helicopter.
Helicopter: Tail Rotor RPM	Check this item to display the tail rotor RPM of the helicopter.
Engine: Battery Remaining	Check this item to display the remaining capacity in the battery pack.
Engine: Current Draw	Check this item to display the amount of current that the motor is draining from the battery pack.
Engine: Energy % Remaining	Check this item to display the amount of fuel or battery charge remaining, as a percentage.
Engine: Fuel Remaining	Check this item to display the amount of fuel remaining.
Engine: Motor Efficiency	Check this item to display the efficiency of the electric motor.
Engine: Power In	Check this item to display the amount of power being transferred to the electric motor.
Engine: Power Out	Check this item to display the amount of power being generated by the engine.
Engine: RPM	Check this item to display the RPM's of the engine. Please note: This measurement does not take into account any gear reduction which might be utilized.
Engine: Voltage	Check this item to determine the voltage across the electric motor.
Environment: Wind Direction	Check this item to display the direction that the wind is blowing.

Environment: Wind Speed	Check this item to display the velocity of the wind at the current time.
Environment: Wind Updraft	Check this item to display the velocity of the wind in the upward direction.
Pilot: Distance to Aircraft	Check this item to display the current distance from the pilot to the aircraft.
Pilot: Field Of View	Check this item to display the field of view angle for the main window.
Pilot: Height (AGL)	Check this item to display the height of the pilot above the surface below, water or ground.
Pilot: Height (ASL)	Check this item to display the height of the pilot above sea level.
Pilot: Height (ATL)	Check this item to display the height of the pilot above the terrain, not including any body of water.
Pilot: Height (AWL)	Check this item to display the height of the pilot above the body of water at the airport.
Pilot: Look Direction	Check this item to display the compass direction in which the pilot is looking.
Pilot: Zoom Magnification	Check this item to display the amount of zoom being utilized; 1 is equivalent to normal eyesight.
System: Graphics Frame Rate	Check this item to display the number of times the screen updates per second.
System: Physics Frame Rate	Check this item to display the number of times the physics system updates per second.

### Color-

This setting allows you to adjust the Color for the selected item when displayed in the NavGuide gadget. To select an alternate Color, first click the Custom option, and then click on the color swatch. This will open the color palette dialog and you may choose an alternate color for the item.

For example, highlight the Graphics Frame Rate in the NavGuides listing. Next, click the color swatch and select the desired color. The Graphics Frame Rate will now be indicated in the desired color.

### Gadget Options-

The Gadget Options panel found at the bottom of the Edit NavGuides dialog affects all checked NavGuide options, not just the currently selected item.

Some NavGuide items are not relevant to the aircraft you are flying. For example, **Fuel Remaining** is not pertinent to an electric aircraft. In this case, you might check both **Fuel Remaining** and **Battery Remaining**, and then check the box labeled **Manage NavGuide item visibility automatically**. RealFlight will then automatically

hide the NavGuide item from the gadget that doesn't relate to the currently selected aircraft.

As the name suggests, the Gadget Text allows you to set the font size of the text on the NavGuide to either Small or Large.

### Restore Defaults-

The **Restore Defaults** button returns all NavGuides to their default values and options.

### Radio Mode (gadget only)-

This option allows you to change the Mode in which the on-screen radio is displayed. For example, if you prefer to fly with the throttle and rudder on the left stick, and ailerons and elevator on the right stick, then you fly Mode 2. Some modelers prefer Mode 1. In this mode, the left stick controls the rudder and elevator; the right stick controls the throttle and ailerons.

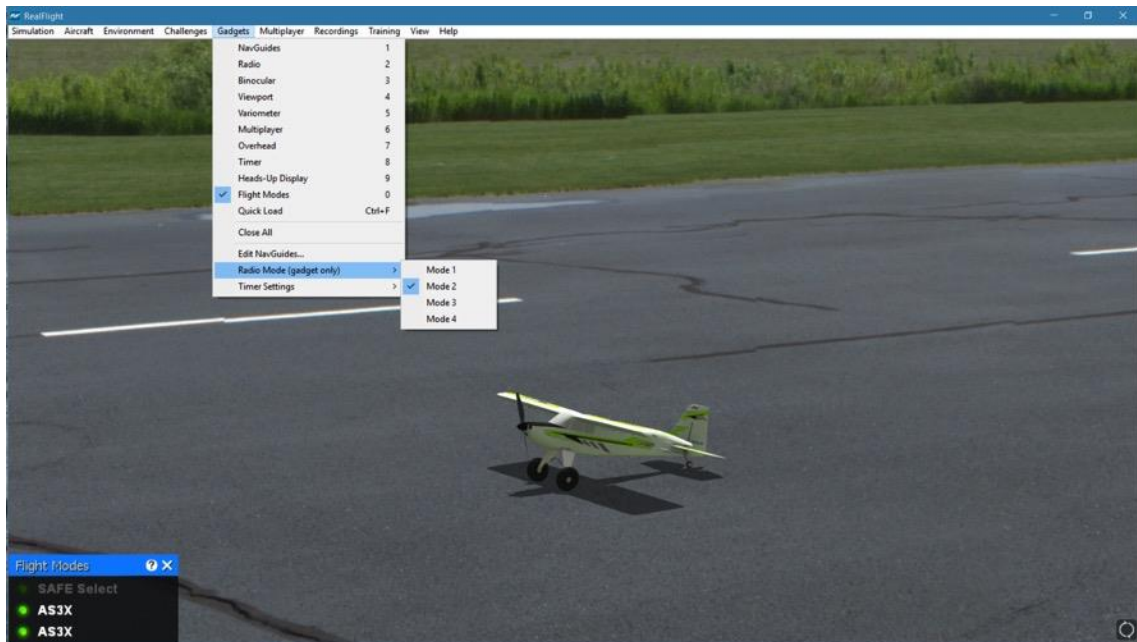

Whichever mode you fly, you will want the on-screen radio to match. Select **Radio Mode (gadget only)** to show the list of available radio modes. Click the mode that is appropriate for you.

### Timer Settings-

This option allows you to change how the Timer gadget operates. Instead of manually clicking the Start/Stop or Reset buttons with the mouse, it is possible for RealFlight to control these for you by linking them to the InterLink DX controller.

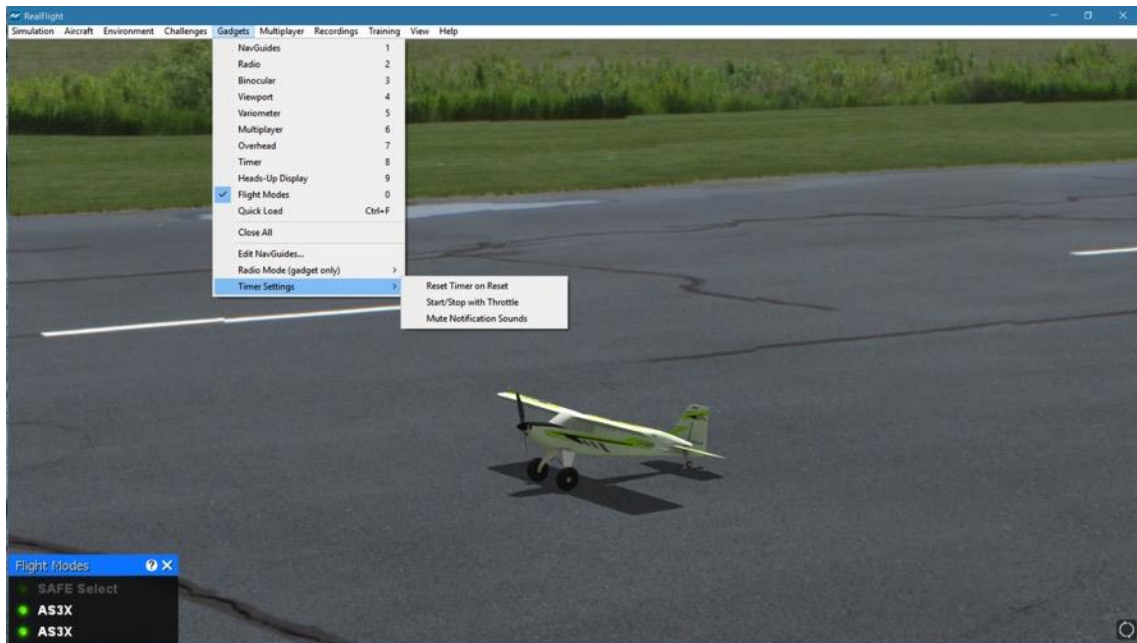

- Reset Timer on Reset – When enabled (a checkmark will appear next to the menu item), the Timer gadget will reset to zero whenever you reset the aircraft.
- Start/Stop with Throttle – With this enabled, the Timer gadget will start when the throttle is increased. When the throttle is at idle, the Timer gadget will stop. The timer is cumulative, however, assuming that the model is not reset. For example, if you land at 1:00 and close the throttle and then decide to take off once again, the Timer will start from 1:00 and count upwards.
- Mute Notification Sounds – Enable this menu option if you would like the Timer gadget to eliminate timer sounds.



# Multiplayer Menu

*FLY WITH FRIENDS, AT THE SAME COMPUTER, OR OVER THE INTERNET.*

The Multiplayer option allows you to fly with many other RealFlight 9 users. These pilots can be across the street, around the block, or around the world!

There are two ways to link up with the additional pilots: via a LAN (Local Area Network), or over the internet. In order to do so, you will need a TCP/IP connection either through your LAN or an ISP (Internet Service Provider).

Every session requires someone to serve as host. The host initiates the multiplayer session. When the Host starts a session, other participants may join in.

The Multiplayer menu allows you to access a variety of multiplayer-related features, functions, and options. Clicking the **Multiplayer** menu brings forth a pull-down menu which will look similar to the following screen shot:

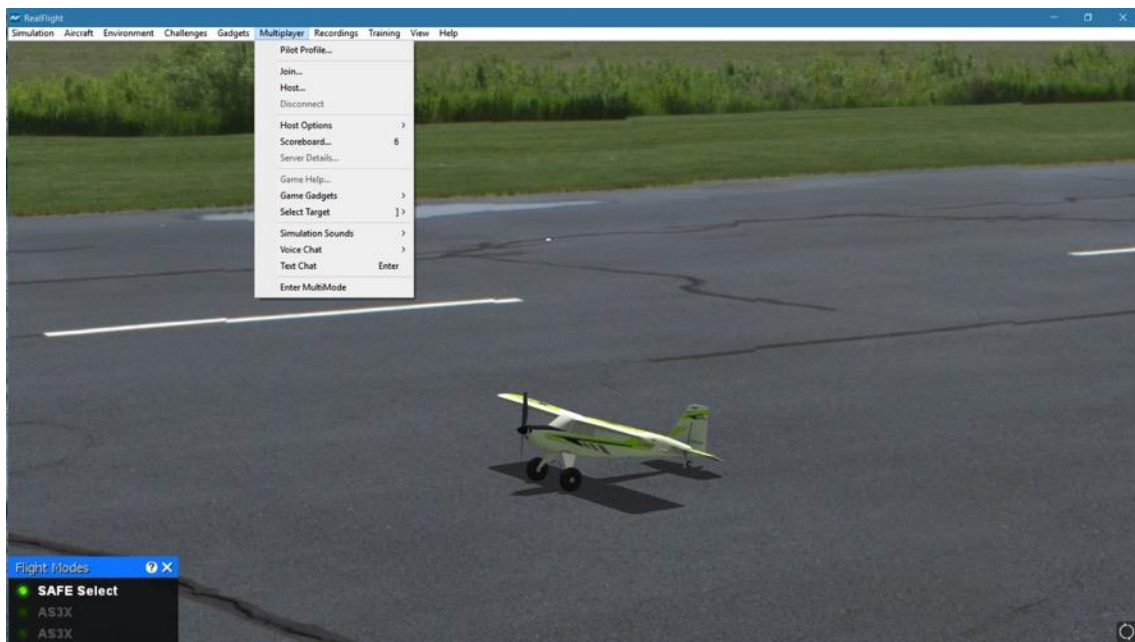

Some of these items will be grayed out or disabled if they do not apply to the current situation. For example, you cannot disconnect unless you are currently connected. As such, the Disconnect menu item is grayed out unless you are in a multiplayer session.

When you participate in a multiplayer session, the menu commands you will access depend on whether you are the host or whether you opt to join someone else's session. These commands also depend upon whether you already have a specific session you want to join.

It is possible to participate in a public session using our List Server. The List Server is a publicly available list of open RealFlight sessions. Currently, we provide the List Server to all RealFlight owners, free of charge. The List Server allows you to participate in multiplayer sessions with other RealFlight users anywhere in the world.

***IMPORTANT INFORMATION ABOUT THE LIST SERVER: At the time of this writing we are providing the List Server service on a trial basis. This service may be modified, interrupted, or canceled at any time without notice. In particular, we make no guarantee about the reliability of this service. To use this service, you may need to obtain product updates. Mention of the List Server in this manual does not imply that this service will be available at the time you purchase this product. Moreover, we reserve the right to bar any individual user, or all users at individual IP addresses or domains, from using the list server at our discretion. Abusive behavior, for example, will not be tolerated.***

### Important Multiplayer Connectivity Tip: Port Forwarding-

If you are connected to the internet behind a router (cabled or wireless) or software firewall, you may need to open up access to a certain range of port numbers before RealFlight can successfully connect for multiplayer gameplay.

Please Note: If you are unfamiliar with how to set up port forwarding on your router device and/or software firewall product(s), please refer to the supporting documentation (installation guide, user's manual, etc.) that came with the networking hardware or software you are using, or you may also try contacting the manufacturer's technical support for those products.

For RealFlight multiplayer gaming, by default the following port ranges must be forwarded to the client IP under the UDP traffic protocol:

61234-61241

You may adjust this range in the RealFlight Settings dialog window. See section

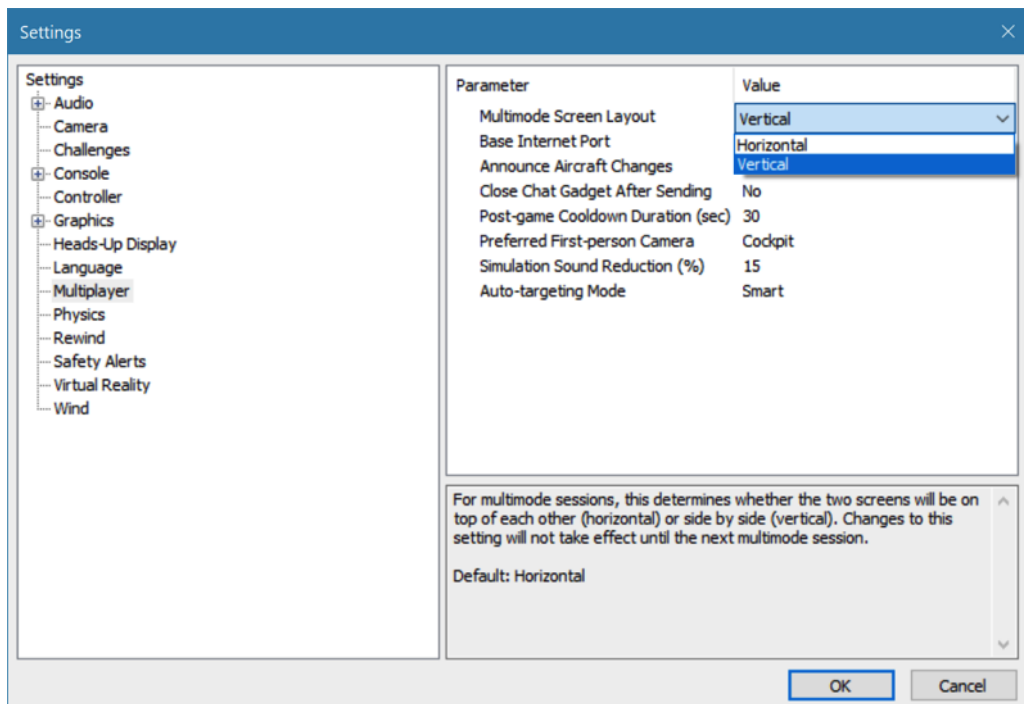

Base Internet Port- on page 111.

## Pilot Profile

The Pilot Profile allows you to customize the information about yourself. This information is available to other pilots during multiplayer sessions.

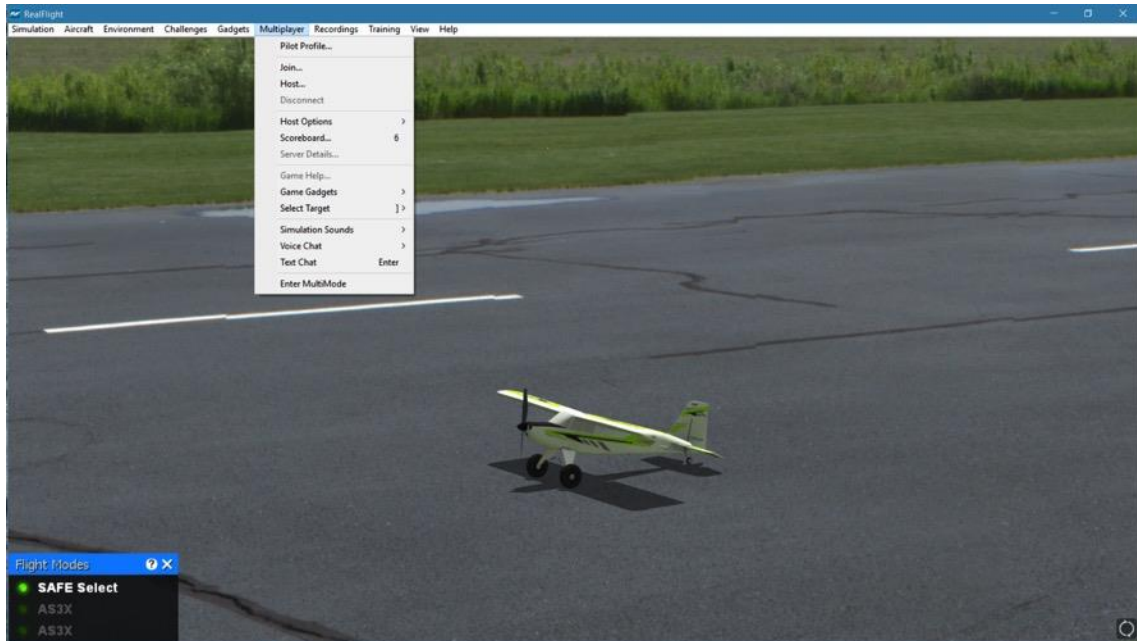

The Pilot Profile will also display the first day you ran RealFlight 9 (shown as your License Date), and keep track of the number of days, hours, and minutes you have spent flying the simulator (shown as Hours Logged).



The items that you may change for the Pilot Profile are as follows:

- Avatar – The image on the left-hand side of the profile is your avatar. An avatar is a graphical representation of one's self commonly used on the internet. RealFlight allows you to choose from a variety of avatars in your Pilot Profile. To do so, click on the avatar to display arrows at the bottom of the image. Clicking either arrow will cycle through the different avatars that are available. To select an avatar, click **Apply**. Alternatively, click **OK** to exit the Pilot Profile.
- Name – DVD and Tower Hobbies Digital versions of RealFlight also allow you to select a name for use in the simulation. Click the field below the Name label and type the name you wish to appear. Steam versions of RealFlight use your Steam user profile name (unsupported characters are automatically removed).
- Location – RealFlight 9 also allows you to enter your location. Click the field under Location to edit this information.
- Favorite Color – Click either arrow next to the color to pick your favorite color. This color will be used for your avatar background, streamers, and paintballs during multiplayer sessions.
- Tagline – Edit this field to display a short line about yourself, or use it to taunt your fellow pilots.
- Additional Information – The field at the bottom allows more room to add any additional information you wish to share.

As noted previously, the Pilot Profile is visible to other pilots during multiplayer sessions. Do not enter any personal information in the Pilot Profile that you are not comfortable sharing with other pilots.

Upon completing the Pilot Profile, click **OK** to retain these settings and close the window.

## Join

This option allows you to participate in a Multiplayer session without being the Host of the session yourself.

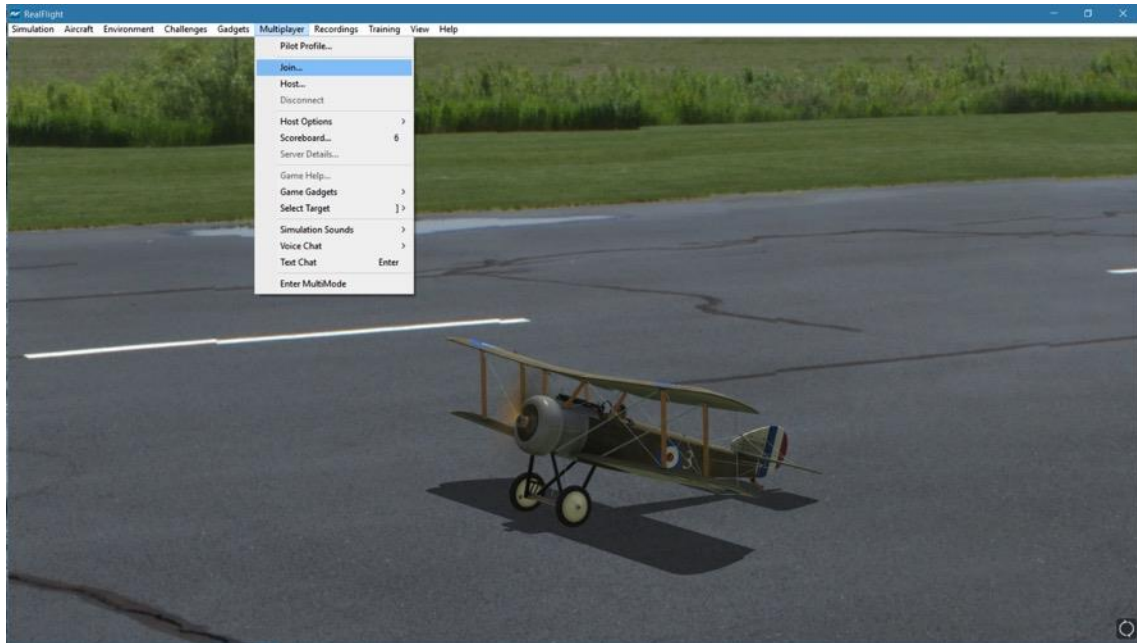

To access the Join... menu item, click on the **Multiplayer** menu followed by the **Join...** menu item.

Before you can join a session, you will need a network connection.

## Join Session-

This dialog allows you to select the multiplayer session that you wish to join. It also provides a variety of information pertaining to the various sessions available.

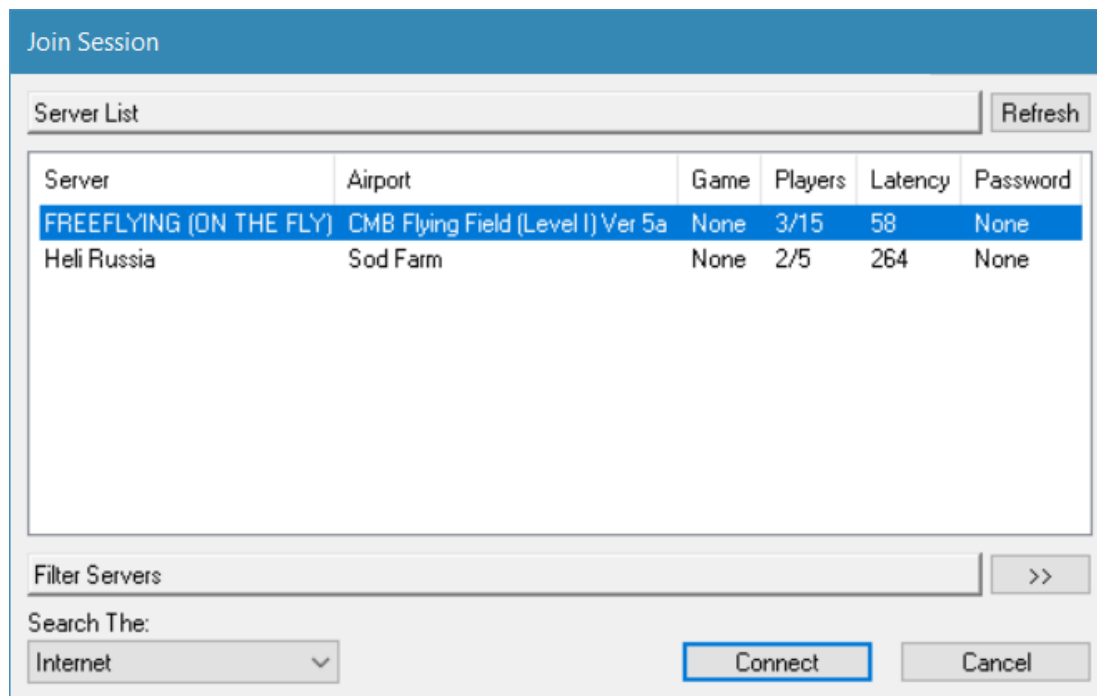

### Server-

The Server column displays the names of all available sessions. If you have not searched for (and found) a session, this column will remain blank.

### Airport-

This column shows the currently selected airport being utilized by the host.

### Game-

If there is a game in progress, this column shows the game that is currently running.

### Players-

This column indicates how many players are participating in a given multiplayer session. It also indicates the maximum number of participants allowed for the session. The host determines the number of allowable participants.

### Latency-

Latency is the amount of time it takes a packet of information to travel from its source to the destination. The larger the number, the slower the information travels. High latency can result in sluggishness and “lag” while running the simulation. As such, you will want to avoid sessions where the latency number is high.

### Password-

This column indicates whether or not a password is required to join a particular multiplayer session. This allows the host to maintain a private session for friends, family, etc.

### Search-

The bottom left corner displays a drop-down selection box indicating the location that you wish to search for multiplayer sessions. RealFlight 9 will search the List Server (Internet) or the Local Network (LAN) for multiplayer sessions.

To determine the Search area, click the down arrow. This activates the pull-down selections. Click on the location that you wish to search.

After making your selection, RealFlight will automatically search for multiplayer sessions at the desired location. When the search completes, the available sessions and information appear in the server list dialog box above. To select one of these sessions, click on the respective session and then click **Connect**. Alternatively, you may double-click on the Session Name to join.

Please note: If a multiplayer session is private, RealFlight 9 will ask for a password in order to join. If you know the password for the session, enter it now.

### Refresh-

To repeat the search for multiplayer sessions, click the **Refresh** button located in the upper right corner of this dialog window.

Also, if you are using an updated version of Windows XP (Service Pack 2 or later), Windows Vista or Windows 7, you may have Windows Firewall installed and running. If this is the case, Windows Firewall warning dialog may appear (similar to that shown below) the first time you use the Search function. You must select the Unblock or Allow Access option in order to allow RealFlight 9 to continue searching.



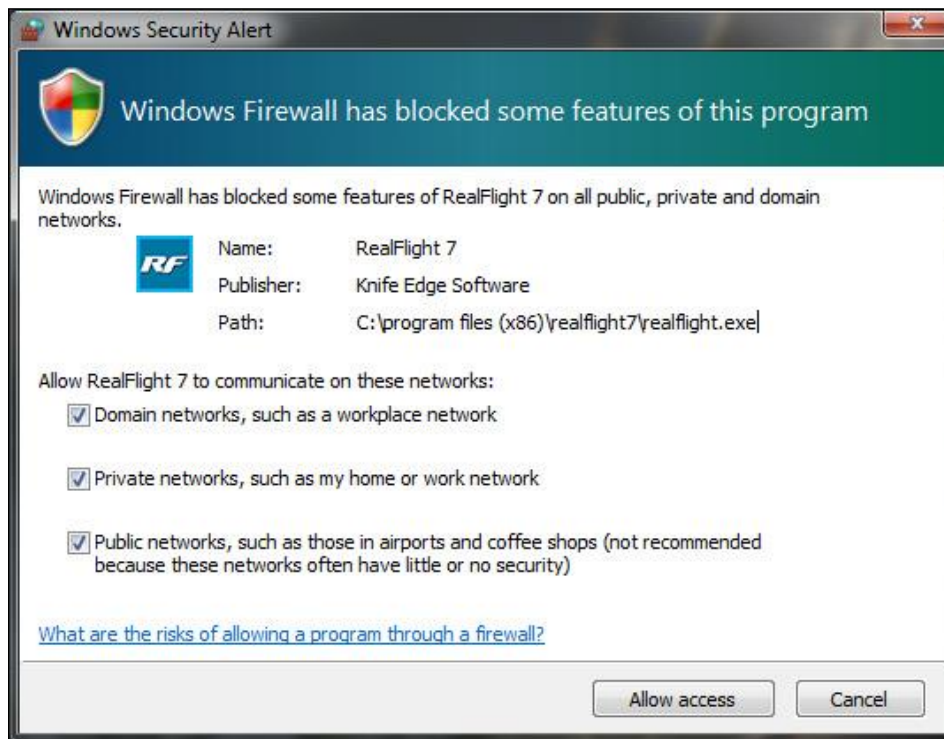

### Filter Servers-

Below the List Server is an option to filter your search results. If a large number of multiplayer sessions are listed, you may want to narrow your search results to quickly and easily find the session you wish to join. Filter options include:

- Server Name – If you know the name of the session you wish to join, type it in this field.
- Airport – If you wish to participate at multiplayer sessions only at certain airports, you can select that airport from this drop-down.
- Game – Like the Airport option, if you wish to find sessions running a particular event, you may select it from this drop-down.
- Free Slot – Use this drop-down to select sessions that have a certain amount of open player slots.

## Host

Every multiplayer session requires one participant to function as the host. If you are the host, you will be the one who starts the session. The host is also the one who starts and ends the events.

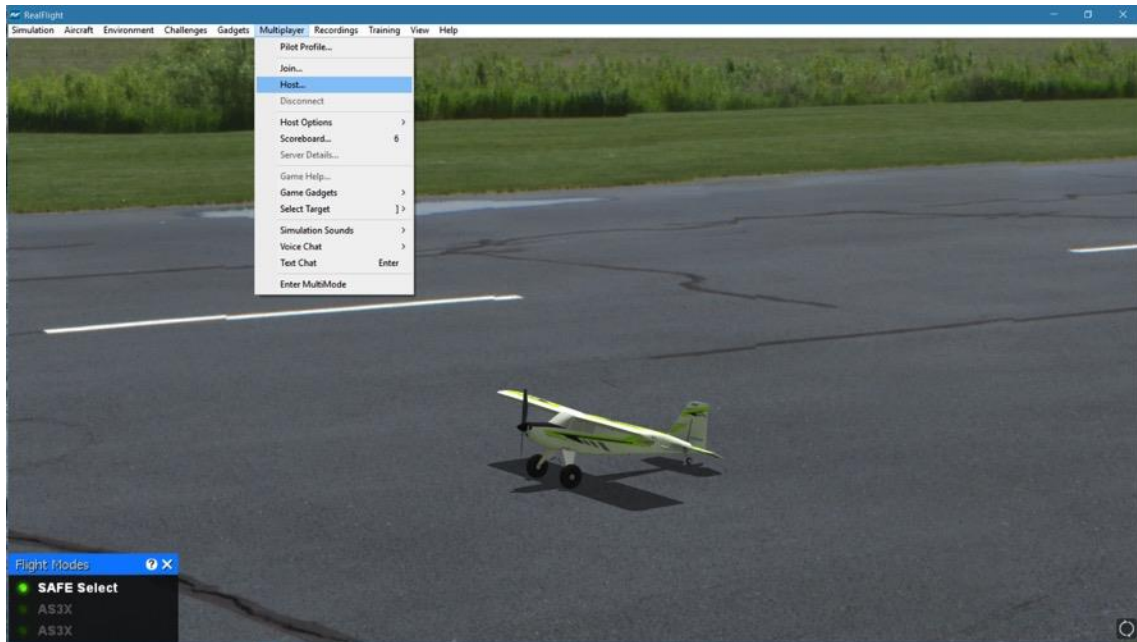

Once you have started the session, other players may join in as they wish. Unless you opt to make your session private, the session will be open to all RealFlight 9 owners searching for multiplayer events.

To access the Host... menu item, click on the **Multiplayer** menu followed by the **Host...** menu item.

## Host Information-

The Host Information allows you the ability to name your multiplayer session. You can also choose the maximum number of pilots and whether or not to make your multiplayer session public or private.

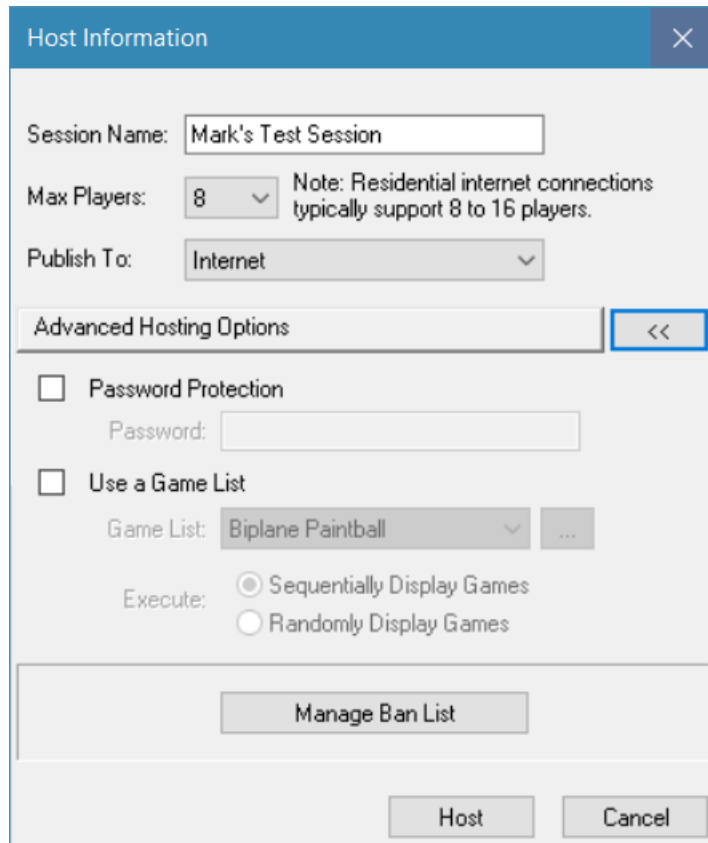

The screenshot shows the 'Host Information' dialog box. At the top, there is a title bar with the text 'Host Information' and a close button (X). Below the title bar, there are several input fields and options:

- Session Name:** A text box containing 'Mark's Test Session'.
- Max Players:** A dropdown menu showing '8'. To its right is a note: 'Note: Residential internet connections typically support 8 to 16 players.'
- Publish To:** A dropdown menu showing 'Internet'.
- Advanced Hosting Options:** A section header with a double-left arrow button (<<) to its right.
- Password Protection:** An unchecked checkbox. Below it is a text box labeled 'Password:'.
- Use a Game List:** An unchecked checkbox. Below it is a dropdown menu labeled 'Game List:' showing 'Biplane Paintball' and an ellipsis button (...).
- Execute:** Two radio buttons: 'Sequentially Display Games' (selected) and 'Randomly Display Games'.
- Manage Ban List:** A button located below the 'Execute' options.
- Host and Cancel:** Two buttons at the bottom right of the dialog.

### Session Name-

Using the keyboard, enter the name of the session that you will be hosting.

Please note: This is the name of your session, not necessarily your personal name. In fact, you might find it useful to use a descriptive name such as "3D Fun Fly." This is particularly useful when other participants are searching for a session to join.

### Max Players-

To adjust the maximum number of players allowed in your session, click the down arrow.

Currently, a multiplayer session may not have more than 32 members. If the host computer is somewhat slow or has a poor internet connection, you may want to limit the number of participants. We suggest 8-16 players for typical residential internet connections.

### **Publish To-**

This option allows you to choose how other people will find and connect to your multiplayer sessions. There are two options available.

- Internet – This option will publish your session on the RealFlight List Server, so anyone in the world can connect to you.
- LAN – Short for “Local Area Network”, choose LAN if you wish to host a multiplayer session on your local home or work network. For others to join, they must also connect from the same local network. This option will not list your session on the RealFlight List Server.

With the Host Information dialog window open, you may click the **Advanced Hosting Options** arrows for additional options. Some of these options are also accessible from the Multiplayer menu, after the multiplayer session has already been started.

### **Password Protection-**

Should you wish to host a private multiplayer session, you may choose to set a password to prevent other random pilots and participants from joining. If you choose to password protect your session, you will need to share this password with the people you want to join.

To enable and set the password, check the box to the left to activate the password field, then enter the desired password accordingly.

### **Use a Game List-**

Check this box to enable the different Game List options. This will allow you to automatically run a Game List at the start of the multiplayer session. When enabled, the available options are:

Game List – This drop-down box shows all Game Lists available. If you want to manage or create a new customized list, click the “...” next to the drop-down. If you wish to create a customized Game List, there are a number of options available. This includes Airport selection, Game type, Duration and Points. To do so, click “Configure...” to access the Manage Game options.

Execute – This determines the order in which each contest is loaded in the Game List.

These options are also available from the Multiplayer menu if you wish to select them at a later time. For more information about Game Lists, turn to page 232.

## Manage Ban List-

Click this button to display the Ban List dialog window. This option is also available from the Multiplayer menu. See page 236 for more information.

## Port numbers-

Prior to hosting a multiplayer session it is important to note that if you are connected to the internet behind a firewall or a router, you might need to open up access to a certain range of port numbers. RealFlight 9 looks for an open port from 61234 to 61241 by default. For more information on how to open these ports, please refer to your firewall or router's manual.

## Disconnect...

This menu item is used to disconnect from, or exit, the multiplayer session.

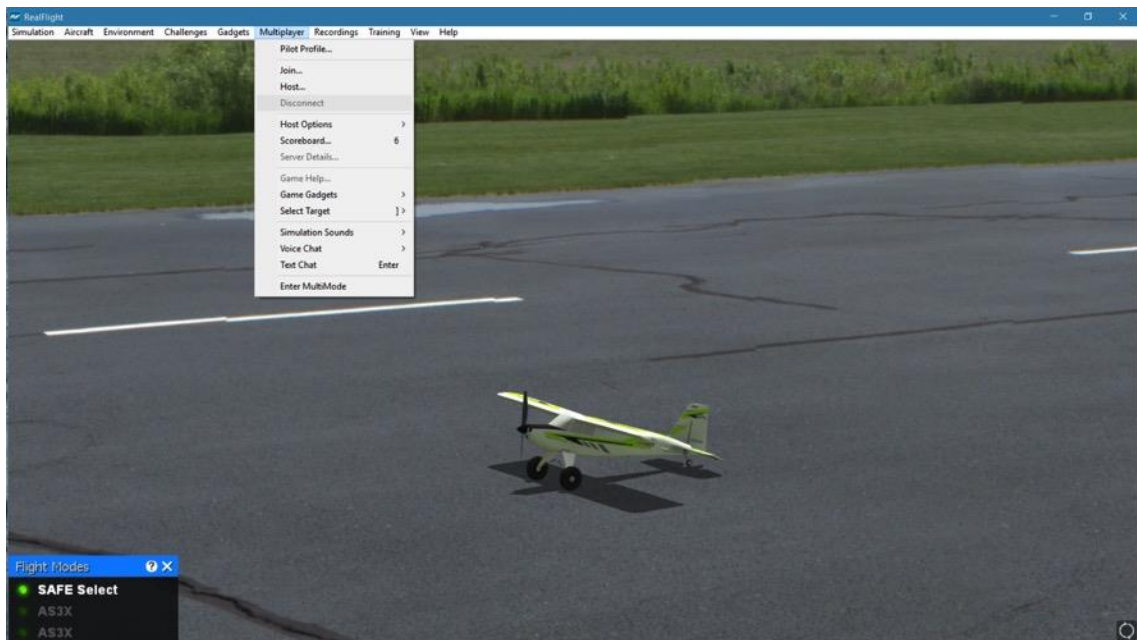

To access the Disconnect... menu item, click on the **Multiplayer** menu followed by the **Disconnect...** menu item.

Please note: If you are not currently participating in a multiplayer session, this item will be grayed out and will not be accessible.

## Host Options

This menu option will open a sub-menu that allows the host of a multiplayer session a variety of options to start, stop, and manage events. Many of these menu items are not accessible unless you are currently hosting a multiplayer session.

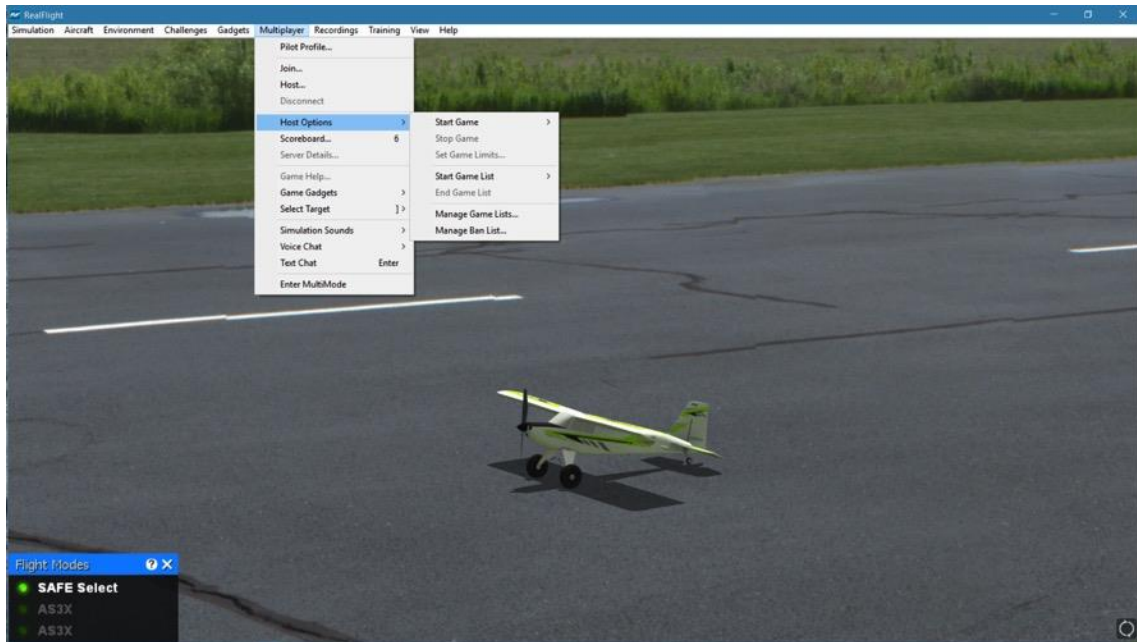

### Start Game-

To start an individual game at the airport currently loaded, select the event from the list that appears in this sub-menu. The options are:

- Combat (Biplanes) – Full-fledged combat with machine guns and rockets flying the Sopwith Pup.
- Combat (Jets) – Full-fledged combat with machine guns and rockets; flying the L-39.
- Combat (Unlimited) – Aircraft choice is up to the participants. Of course, we recommend utilizing an airplane equipped with the proper combat equipment.
- Combat (Warbirds) – Full-fledged combat with machine guns and rockets; flying the P-51 Mustang.
- Combat Aces (Warbirds) – A more challenging version of Combat.
- DeadRinger – Race to fly through all the rings (in any order), but don't get shot down in the process.

- Fun Fly – An open event without any weapons or scoring involved.
- Hardcore Combat (Biplanes) – Like the Combat event, but with limited ammo and bonuses. You can only shoot from the cockpit camera flying the Sopwith Pup.
- Hardcore Combat (Warbirds) - Like the Combat event, but with limited ammo and bonuses. You can only shoot from the cockpit camera perspective flying the P-51 Mustang.
- Paintball (Biplanes) – Fly combat, shooting paintballs in the Sopwith Pup.
- Paintball (Warbirds) – Fly the P-51 Mustang and shoot paintballs at your opponents.
- Rocket Wars (Foamies) – Fly the Multiplex Parkmaster and battle each other shooting rockets.
- Streamer Cut (Biplanes) – Fly the Sopwith Pup in traditional RC combat with streamers.
- Streamer Cut (Foamies) – The traditional RC combat with streamers, flying the Multiplex Parkmaster.
- Streamer Cut (Jets) – Take to the skies in the L-39 and try to cut your opponent's streamer.
- Streamer Cut (Warbirds) – Like the other streamer cut events, only this time you will be piloting the venerable P-51 Mustang.

### Power-Ups-

When a combat event is in progress, a number of Power-Ups will be available, scattered about the airport. These Power-Ups will benefit you by offering points, additional ammunition, fuel, and other items of interest. Not all Power-Ups appear at every game. For example, during a Streamer Cut game, you will not see Power-Ups that will replenish your ammunition, as it is not applicable.

To acquire or activate the Power-Up, simply fly through it during the game. Some Power-Ups will affect you, while others will affect everyone else.

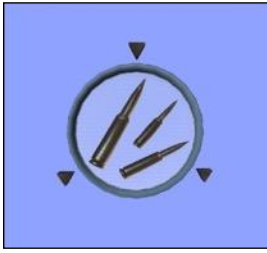

This Power-Up restocks your bullet ammunition.



If you are running low on fuel or battery power, fly through this Power-Up.

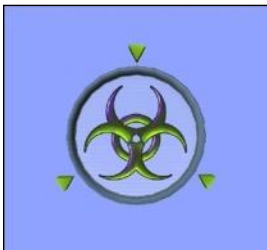

Flying through this Power-Up will only “infect” the other participants in the game, yet leave you unharmed. The effects vary depending upon the game. In Streamer Cut, for example, all streamers except for yours will be twice as long. If the event utilizes Paintballs, Guns, or Rockets, your opponents will be unable to fire. This is a temporary Power-Up.

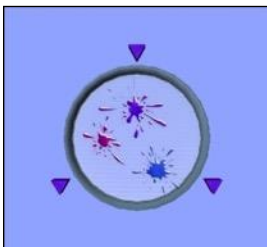

During Paintball combat, if you are running low on ammunition, fly through this Power-Up to receive more paintballs.



Fly through these Power-Ups to obtain bonus points. If you have negative points, these Power-Ups are useful to erase the deficit.





This is the one Power-Up to avoid at all cost. This Power-Up functions in reverse of the Infect Power-Up, whereby it harms you providing the advantage to your opponents.



You never know what you will receive with this Power-Up. As the name suggests, this Power-Up will randomly act like one of the other Power-Ups when you fly through it.

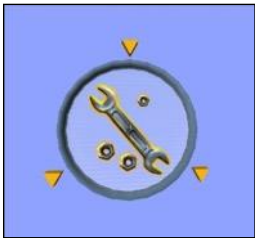

If your health is low during combat games with guns and rockets, fly through this Power-Up to repair your aircraft.



Restock the quantity of rockets by flying through this Power-Up.



For temporary immunity from your competitors, grab the Shield Power-Up. While this prevents your aircraft from obtaining damage from your opponents, the shield does not protect you from crashes.

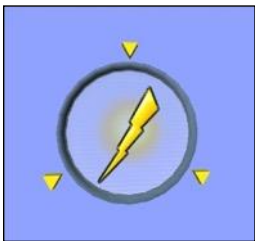

Get the advantage over your opponents with the Speed Boost Power-Up. This will allow you to fly faster for a short period of time.



Don't be so quick to hit that Reset button if it is not required. Each time you reset during a combat event, you will lose 15 points. Resetting also eliminates any Power-Ups you might currently have.

### Stop Game-

Select this to stop the currently running game. This option is only available if you are the host of the multiplayer session and are running a single game, not a Game List.

### Set Game Limits-

Select this menu item to open a window that allows you to alter the game limits.

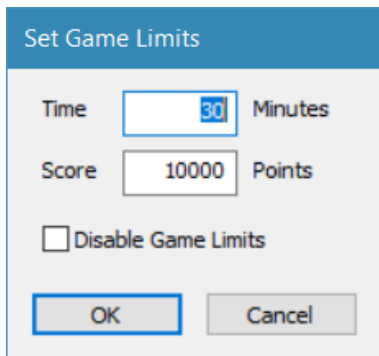

The image shows a dialog box titled "Set Game Limits". It contains two input fields: "Time" with a value of "30" and "Minutes" next to it, and "Score" with a value of "10000" and "Points" next to it. Below these fields is a checkbox labeled "Disable Game Limits" which is currently unchecked. At the bottom of the dialog are two buttons: "OK" and "Cancel".

The game will end when one of the limits is met. For example, if you wish for the game to end when the first player reaches 100 points, enter "100" in the **Score** field. If you wish the game to continue indefinitely, click the checkbox labeled **Disable Game Limits**.

### Start Game List-

This menu item will display all Game Lists available to the host. Selecting one will begin that list, allowing the host to compete and without having to worry about changing the games or time limits. For more information about Game Lists, see Manage Game Lists below.

### End Game List-

If you are currently running a Game List and wish to cease this list, select this menu item.

## Manage Game Lists...-

RealFlight 9 allows you to manage and run a list of events automatically giving you the opportunity to enjoy the competition without worrying about controlling the multiplayer session.

Clicking on this menu item will display the following dialog window:

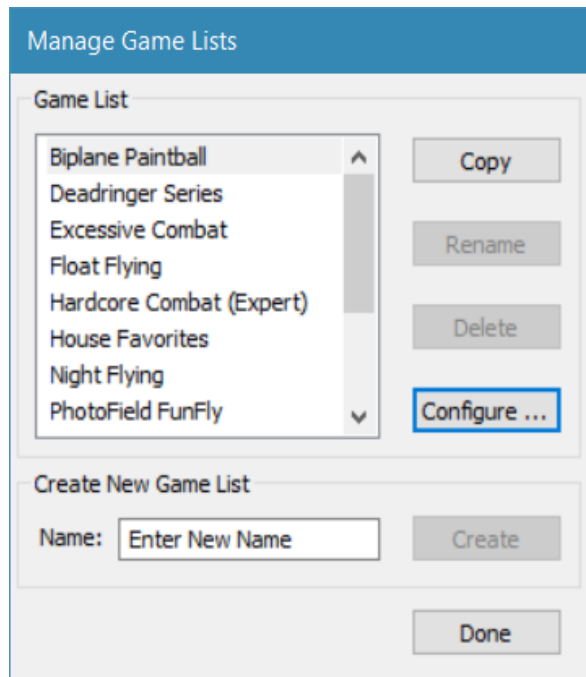

On the left side of this window, it will display the Game Lists available on your computer. A number of pre-configured Game Lists are included with RealFlight 9. To the right of this list are four buttons that have the following functions:

- **Copy** – You are not able to modify the default Game Lists included with RealFlight. However, if you wish to make a change to one of these default lists, you must first make a copy of it. To do so, first select the **Game List** on the left then click the **Copy** button. If you do not rename the Game List, it will appear as “Copy of ....” In the Game List.
- **Rename** – If you wish to rename a Game List, first select it from the list on the left. Then click the **Rename** button. This button will be disabled if the selected Game List was a default list included with RealFlight 9.
- **Delete** – Click this button to delete the selected Game List. Like Rename, this option is not available for the default Game Lists included with RealFlight 9. Please note that after you have confirmed the removal of the Game List, it will no longer be available nor will it be stored on your machine.

- **Configure ...** - To configure the contests, timers and other settings and options for the Game List, select it from the list on the left, then click the **Configure...** button. See below for an explanation on how to configure a Game List.

If you wish to create a completely new Game List from scratch, type in the name of the desired list at the bottom of the Manage Game List dialog window. Next, click **Create**. The new Game List will appear in the list above. You may now add contests and other options to this list. To do so, select the desired contest from the list, then click the **Configure...** button. The following window will appear.

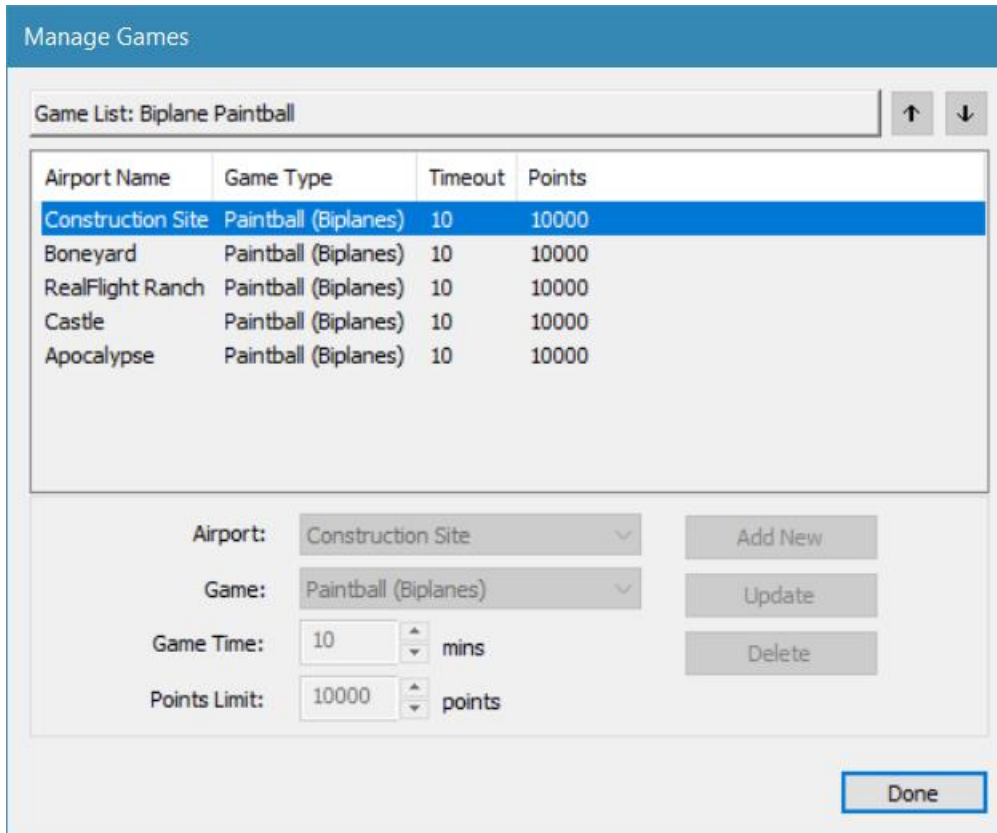

The Manage Games dialog window allows you to add and configure individual games within the Game List. For each event, you have the option to select the airport, contest, the amount of time spent at the game before switching to the next game, and the upper limit of points any player can reach before switching to the next game. You may also modify the order of these events.

Please note: These options are disabled for stock Game Lists that are included with RealFlight 9.

The main pane on this window indicates all games listed for the selected Game List. Each game will list the Airport at which it will load, the contest it will run, and the amount of time that remains in the contest before proceeding to the next game on the list. If you wish to change the order that these contests are loaded, select it from the list, then click either the up or down arrow buttons in the upper, right-hand corner.

There are three main functions available on this dialog window:

- **Add New** – To add a new game to the Game List, select the Airport and Game. If so desired, adjust the amount of time you wish the game to last. Next, click the **Add New** button.
- **Update** – This button enables you to make a change to a game that is already on the Game List. Select the desired game, and then choose your new settings for the Airport, Game and Game Time. Once you have made your changes, click the **Update** button. The Game List will reflect the new settings.
- **Delete** – Finally, if you wish to remove a game from the Game List, simply select it, then click the **Delete** button. The game will be permanently removed from the Game List.

Once you have configured your Game List, click the **Done** button. Your new Game List will now appear as a menu option under the Start Game List. See page 232 for more information about how to start a Game List.

### Manage Ban List...-

Generally speaking, the RealFlight and the RC community are a great group of people, all sharing a common interest and passion for all things aviation. Unfortunately, there are times when some people choose not to abide by the host's rules or wishes, or will otherwise conduct themselves in an inappropriate manner during a multiplayer session. Rather than choking the stuffing out of them, we've taken a more peaceful, yet still equally effective approach, preventing them from ruining your fun. If you are hosting a public multiplayer session, where someone is not behaving in a way you feel is appropriate, you can choose to ban that person.

To do so, click the Manage Ban List... menu item to display the following dialog window.

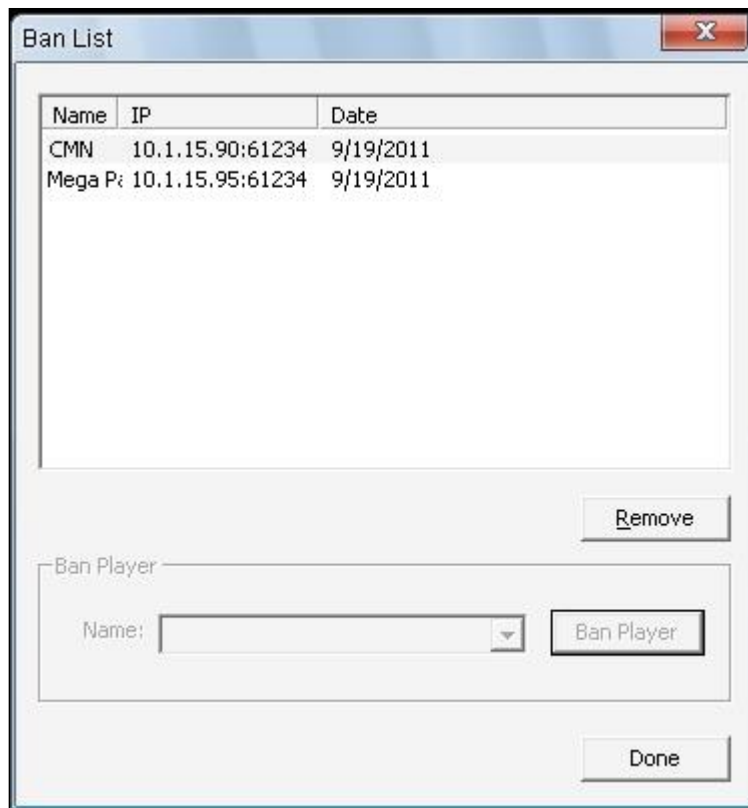

To add a person to the ban list, select their name in the drop-down selection box at the bottom of the window, then click the **Ban Player** button. Their name, IP address of their computer and the current date will appear in the list above. This will prevent them from participating in the events that you are hosting now, and in the future.

If you later change your mind and wish to allow the individual to participate once again, you may remove someone from the banned list. To do so, simply select their name in the list then click the **Remove** button.

6

## Scoreboard

The Scoreboard offers a wealth of information about all the players connected to the multiplayer session, as well as details on the current game (if one is in progress).



If a combat contest is currently in progress, you can show and hide the Scoreboard simply by pressing the **Scroll Wheel/Select** button on the InterLink DX controller. This allows you to display the Scoreboard without taking your hands off the controller and missing that well-placed shot.

The main area in the middle of the Scoreboard displays all players connected to the multiplayer session as well as a variety of useful information. This includes, from left to right:

- Look At – This function allows you to quickly change your camera’s point of view to look at the desired player’s aircraft. To do so, simply click the icon to change your view. The icon will be highlighted next to the current player you are looking at. If you are participating in a combat event, the Look At icon will be represented as a target. If you are simply participating in a multiplayer session, this icon will be represented as an eyeball.
- Pilot Profile – Situated between the Look At icon and the player’s name is a small arrow and the picture of the avatar that player is using. Clicking the arrow will display that player’s Pilot Profile. You may also double-click the desired player’s name to display these contents.



Within the Pilot Profile, you will also notice four buttons along the right side of the Pilot Profile. They include:

- Hide/Show – This button will hide or show the selected player’s aircraft on the screen.



- Mute/Unmute – As the name suggests, this button will mute or unmute the voice chat from this player only. Note that this does not mute your microphone.
  - Kick – Clicking this button will kick (remove) the selected player from the multiplayer session. This is only available to the host of the session. This will not ban a player from reconnecting.
  - Ban – This button will add the selected player to the Ban List and kick the player. Once this is done, this player cannot reconnect. This is only available to the host of the multiplayer session. See the Manage Ban List for more information about banning players.
- Player – This column, as the name suggests, show the player’s name.
  - Points – The Points column will show the points for all players in the current game. This list will automatically order itself, so that the player currently winning will be listed first. Second place is next, and so forth.
  - Crashes – Look to this column to find out how many times a player has crashed during a combat event.
  - Ping – At times, this column can be very important. It displays, in milliseconds, the amount of time data will travel between this player’s computer and the host computer. The lower this number, the better results you will have during multiplayer.

If there is a Game List in progress, more information is available at the bottom of the Scoreboard. At the lower left, it shows the remaining time left for the current event as well as the Point Limit. The lower right corner displays the airport that will be loaded for the next event in the Game List.

## Server Details...

As the host of a multiplayer session, you may choose to edit the details of your server. This information will be displayed to each player as they join your session.



The title bar of the window displays the name of your multiplayer session. This information will be displayed in the server list and also in the Join dialog window when other players search for multiplayer servers.

The top portion of this window displays the host information. This includes the Host Name, or the name that you entered into your Pilot Profile. Also displayed here are the Current Game (if active) and the Current Airport. The Current Game and Current Airport will be displayed in the Join dialog window when other RealFlight users search for multiplayer sessions.

The lower portion contains information which you can edit in a separate file, called `ServerMessage.txt`, located on your hard drive. This file is located in the `\RealFlight 9\Multiplayer` folder within My Documents. If you make changes to this file, the information

will be shared to all players that connect to your multiplayer session. Otherwise, if you leave the ServerMessage.txt file alone, making no changes to the default text, this screen will not be displayed to joining participants.

If you do not wish to see this screen, simply click the checkbox next to **Do not show this dialog again unless it changes** and click **OK**.

## Game Help...

The Game Help window is displayed to all participants at the beginning of a game.

Please note: This menu option is disabled if combat events are not currently in progress.

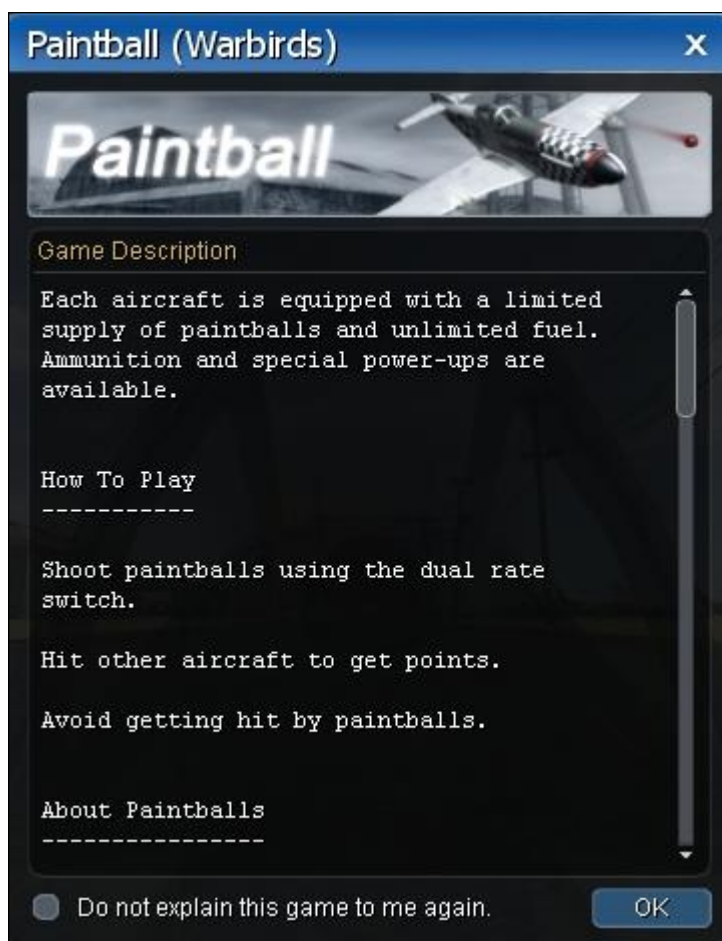

This window will explain how to play the current game, the scoring process, and provide you with other useful information to ensure you enjoy your experience. If you do not wish to see this screen, simply click the checkbox next to **Don't show this dialog again** and click **OK**. Note that this checkbox is independent for each game. For example, if you checked the box to

hide the Game Help dialog from appearing when the Combat (Jets) game was loaded, you will still see this dialog if the Streamer Cut (Foamies) game is loaded.

## Game Gadgets

There are three onscreen gadgets that are only available during multiplayer sessions. Therefore, unlike other gadgets which are located in the Windows menu, you will find these under the Multiplayer menu. Selecting Game Gadgets from the Multiplayer menu will display five choices.

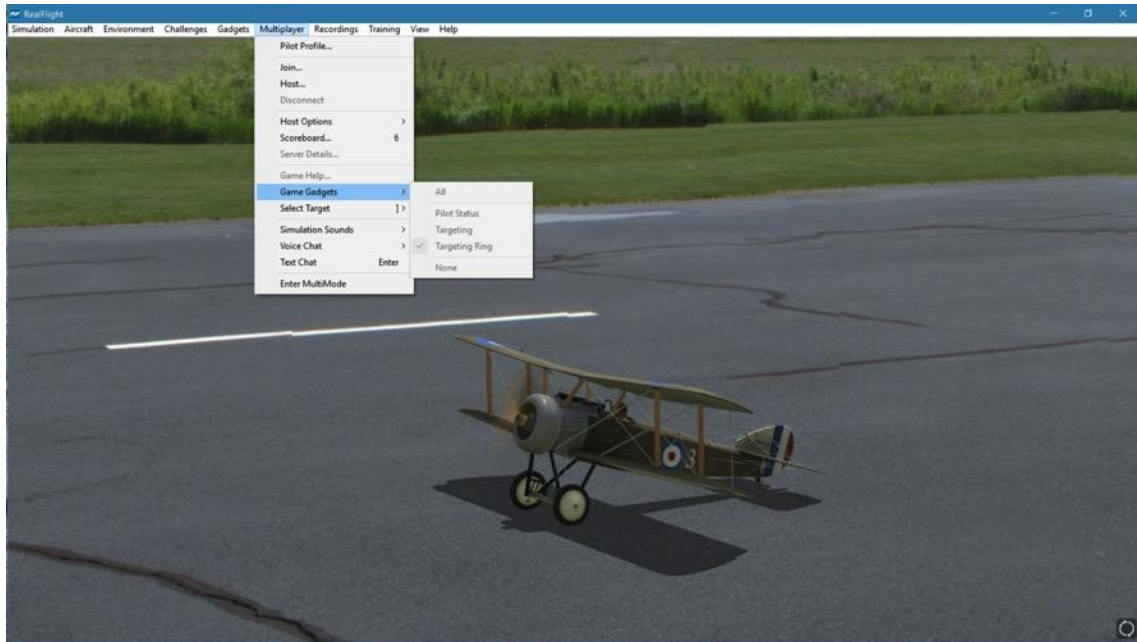

To display all of the Multiplayer Gadgets on the screen at the same time, click the **All** menu item. To remove all of the Multiplayer Gadgets, select **None**.

Alternatively, you may select each desired gadget individually. Each gadget offers unique information about the current game.

### Pilot Status-

This gadget displays pertinent data regarding your current status. The name entered in the Pilot Profile will be noted at the top of the status display. The bottom of this gadget indicates your current score. The middle section displays a variety of progress bars. The level of the progress bar will differ depending on the current status of the game, and the game you are playing. They include:



Fuel – Indication of the remaining fuel or battery power.



Health – In combat with guns and rockets, the health status determines whether your aircraft is destroyed or not. Nearby rocket explosions will cause some damage, where a direct impact will likely terminate your aircraft.

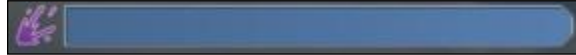

Paintball – This bar displays your remaining paintball ammunition.

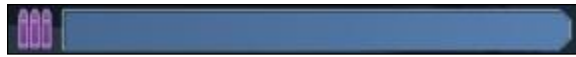

Bullets – This bar indicates the amount of ammunition you have remaining for the machine gun.



Rockets – Like Bullets and Paintballs, this progress bar displays the amount of rockets you have remaining.

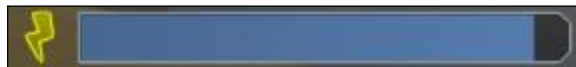

Speed Boost – If you fly through a speed boost Power-Up, this progress bar will appear, showing you the remaining time left until the boost is depleted.

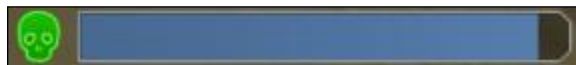

Poison – If you fly through a Poison Power-Up, or if another player flies through an Infect Power-Up, this bar will appear on your screen indicating the amount of time you have left until the infection wears off.



Shield – Flying through the Shield Power-Up will give you temporary immunity from all other players. This progress bar displays the amount of time left before you lose your shield.



Gun Temperature – During hardcore combat events, your guns can overheat and temporarily stop working. You must let them cool down before firing again. If this progress bar fills up completely, your guns have overheated.

## Targeting-

The Targeting gadget displays the player you currently have selected as your target. The avatar for the intended target will appear with their name and score for the current game. Below this will show their Tagline from the targeted player's Pilot Profile.



The Targeting gadget also controls whether the targeting indicator (red triangle) will appear around the selected target's aircraft. This triangle only appears if the gadget is on screen and a player is selected. If no player is targeted, it will read "No Target Selected."



While a game is in progress, the QuickSelect buttons take on new functions. If the targeting gadget is enabled, pressing the **Cancel** button will cycle through the different modes for the Targeting gadget, including:

- Activating the gadget and targeting the last player you had selected as a target.
- Leaving the gadget on the screen, but deactivating the current target; no players are targeted
- Removing the gadget altogether. No players are targeted when the gadget is removed.

Note that when you reset your aircraft, the Targeting gadget may select a new player depending on the targeting settings. See page 112 on how to select the method which the Targeting gadget will operate each time you reset.

## Targeting Ring-

The Targeting Ring, when activated, will appear directly in the middle of the screen. This heads-up gadget helps you locate your currently targeted opponent during combat events.



When displayed, an arrow will appear on the outer perimeter of the circle. This indicates the direction of the targeted aircraft. Note that the arrow will not be displayed if the aircraft appears within the perimeter of the Targeting Ring.

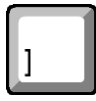

## Select Target



The menu items located in the Select Target menu allows you to select amongst the connected players as a target. Clicking **Previous**, or **Next** will cycle through the players accordingly. Alternatively, you can press the '[' or ']' keys on the keyboard.

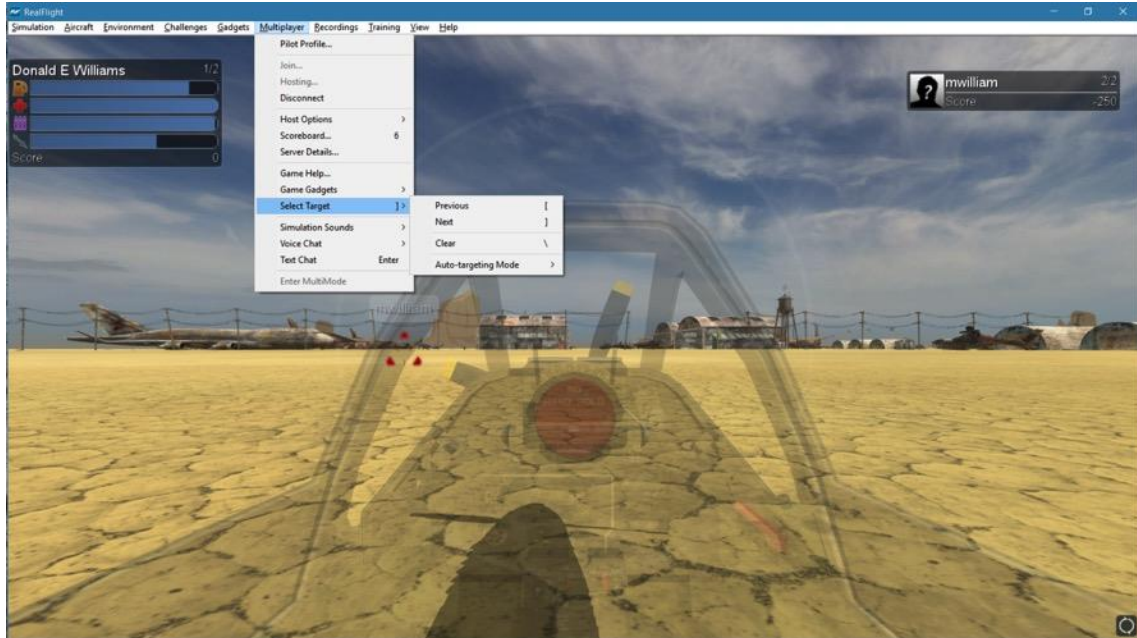

To deactivate the current target so that no players are targeted, simply choose **Clear** from the menu, or press '\`' on the keyboard.



During combat events, you can quickly cycle through different targets using the InterLink DX Select Function. Simply rotate the scroll wheel left or right to select different opponents.

## Auto-targeting Mode-

This sub-menu allows you to set how RealFlight chooses your target during multiplayer events. This takes effect after each reset of the aircraft. The options available:

**Disabled** – RealFlight does not change the targeted player. This allows you to have full control of the targeting system.

**Leader** – RealFlight will target the player with the highest score. If this happens to be you, then RealFlight will select a player at random.



Random – RealFlight will randomly select a player to target.

Smart – All players with a higher score than yourself will be selected somewhat randomly. The player with the highest score and the player that most recently damaged you will have a higher chance of getting selected.

Threat – This option will target the last player that caused damage to you.

## Simulation Sounds

During multiplayer sessions, you may wish to turn down, or off, the sounds generated by the simulator, including engine sounds. This will allow you to better hear and understand other players using voice chat.

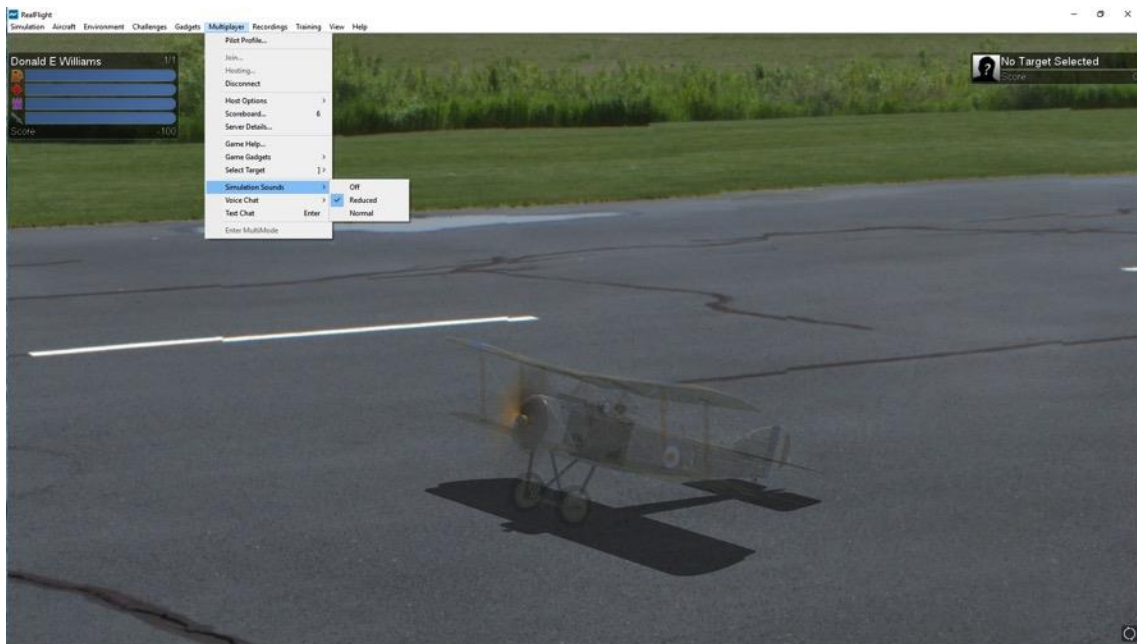

By default, RealFlight 9 will set the Simulation Sounds to **Reduced**. At this setting, you will still be able to hear all of the sounds, including engine noises and crashes, but at a lower volume. Select **Off** to turn off all simulator sounds. If you prefer that all sound settings remain the same in multiplayer sessions as they do offline, select the **Normal** menu item.

## Voice Chat

With a microphone plugged into the computer, RealFlight allows you to talk to other players in a multiplayer session, as if everyone was sitting in the same room.

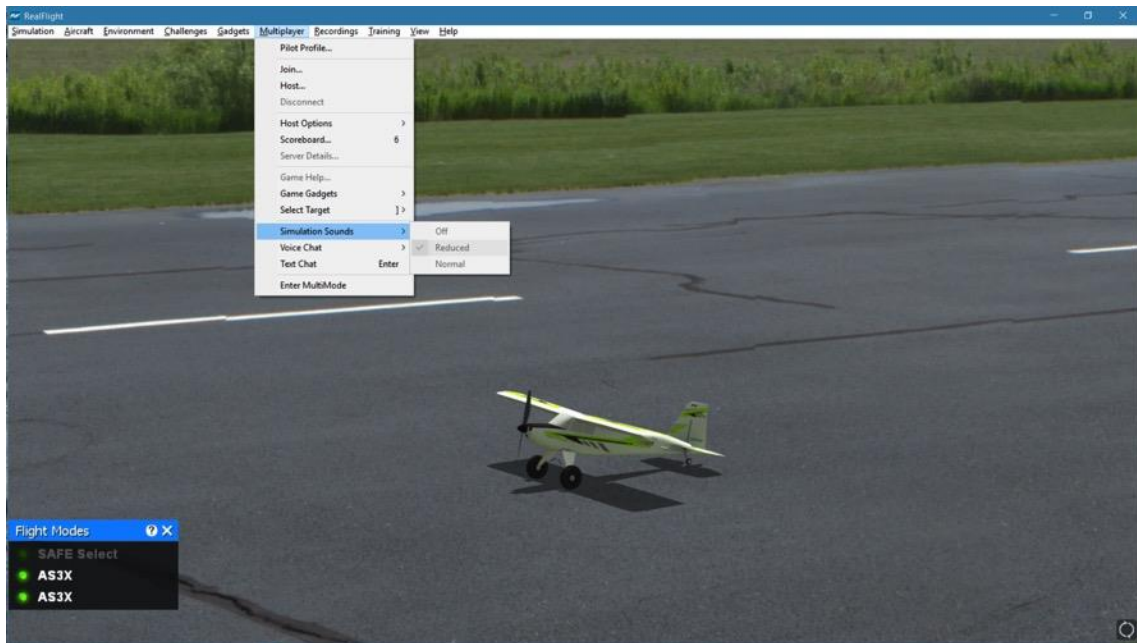

Three options are available when choosing Voice Chat from the Multiplayer menu.

### Enable/Disable-

Choose this menu item to either disable or enable voice chat. When disabled, you will not be able to send or receive voice chats.

### Test Microphone...-

This menu item will bring up a small dialog window, which will allow you to test the microphone connected to your computer. Follow the on-screen instructions to test the microphone.



Select the button that best matches your setup. If you are using a microphone and speakers, we suggest turning the speaker volume down or off. Otherwise, audio feedback could be sent to all participating pilots, making voice chat difficult for all players.

Once you have selected your setup, the following dialog will appear to test the microphone.

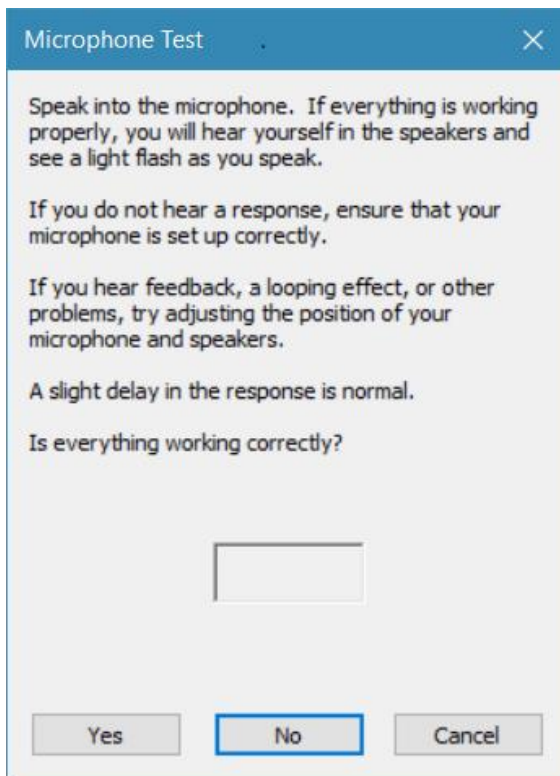

Follow the on-screen instructions. If your microphone test is successful, click the button labeled **Yes**. Doing so will display the following:

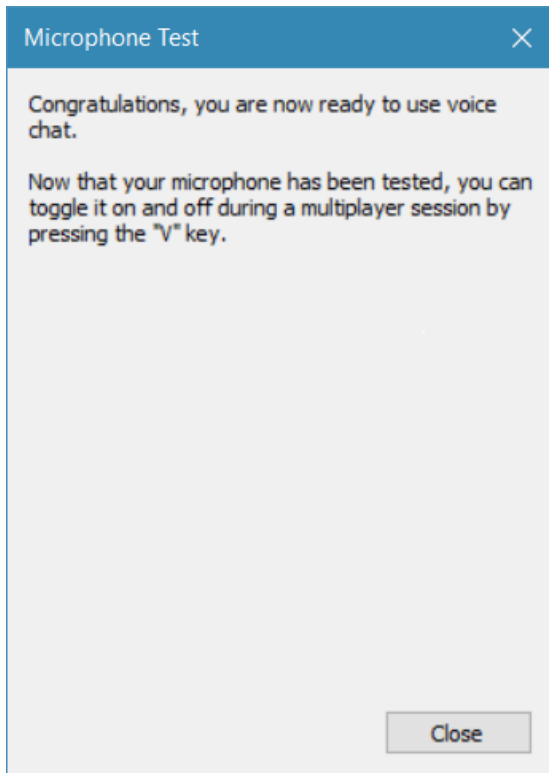

Clicking **No** on the microphone test dialog will display the following screen with troubleshooting tips:

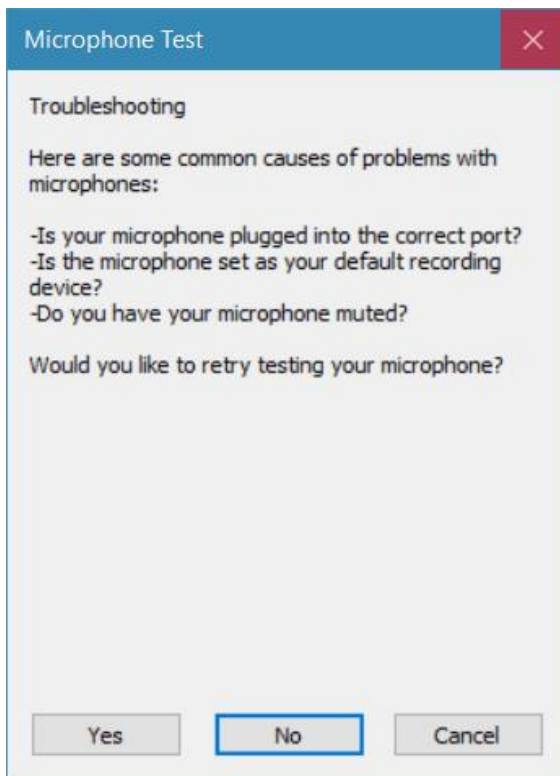

Please note: If you are having difficulties setting up your microphone, please refer to your computer user manual for proper setup.



### **Toggle Microphone On/Off-**

This option will turn on or off your microphone, so other players can/not hear you. You will still be able to hear other players. Alternatively, you can press 'V' on the keyboard to toggle the microphone on or off.

## Text Chat

During Multiplayer sessions, you may want to chat with other participants. Doing so is as simple as typing a message, much like popular instant messenger programs.

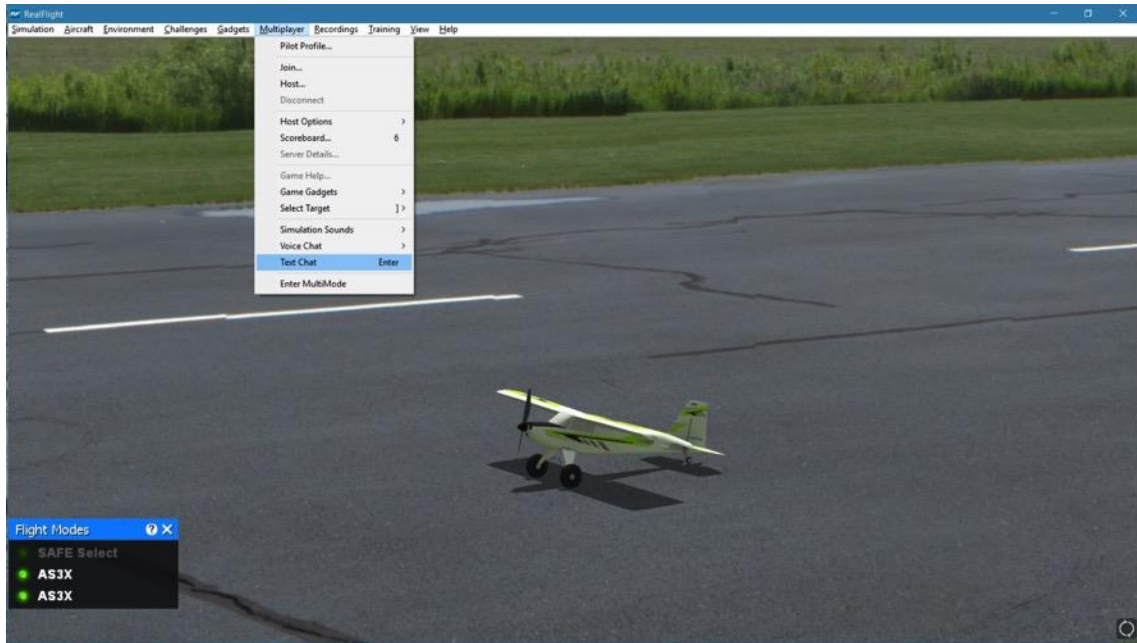

To send a chat message, press the **Enter** key to bring up the Chat field at the bottom of the screen. Using the keyboard, type the message you wish to send. Press the **Enter** key again on the keyboard to send the message.

Please note: All messages are viewable by all participants. RealFlight 9 does not offer private chat.

Any messages received from other participants will appear at the bottom of the screen.

## Enter MultiMode

MultiMode allows you to fly with another pilot on the same PC; with each pilot controlling his or her own aircraft. This feature is ideal for offering personal flight instruction, practicing formation flights, or simply for chasing one another across the skies.

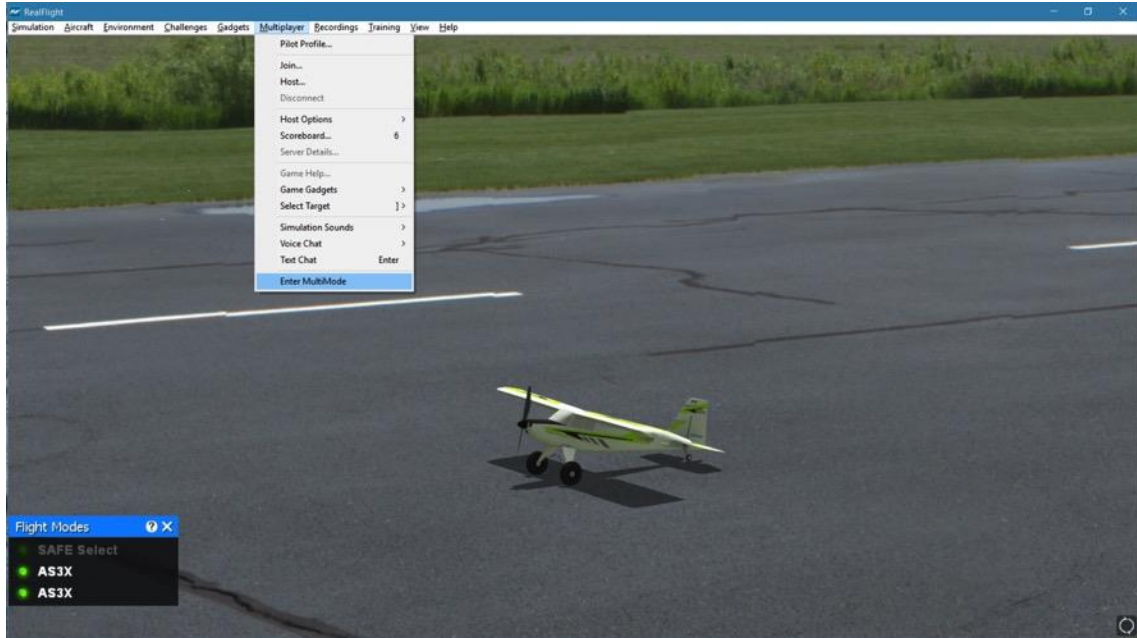

To access the MultiMode menu item, click on the **Multiplayer** menu followed by the **Enter MultiMode** menu item.





MultiMode will split the screen either horizontally (default) or vertically. You can change this option in the Settings window. Simply click the **Simulation** menu followed by **Settings**. On the left side of the Settings screen that appears, choose **Multiplayer**. On the right, you can adjust the **MultiMode Screen Layout** – select either Horizontal or Vertical.

All options available in RealFlight are also available in MultiMode. The difference is most will function on half of the screen that currently is active. To determine which half has the focus or is active, look for the yellow outline. To change focus, click the half that doesn't have the yellow outline. You'll notice the focus changes when you do.

For example, if you are flying in MultiMode with a horizontally split screen, you might notice that the yellow outline is around the top half. If you want to change the aircraft for the person flying on the bottom half of the screen, first click that half of the window, so it has the focus or is the active screen. Next, select an aircraft following the normal procedure.

Please note, there are a number of ways to control the additional aircraft within MultiMode. For example, you may use another InterLink DX or InterLink-X controller. Alternatively, it is possible to use the Spektrum WS2000 Wireless Simulator Dongle as well. For the Wireless Simulator Dongle, please follow the information located on Page 44 of this manual.

To exit MultiMode, select **Exit MultiMode** menu item under the **Multiplayer** main menu.



# Recordings Menu

*SAVE AND PLAY BACK REALFLIGHT MEMORIES.*

The Recordings menu is used to start and stop recordings to assist you in your RC ventures. The RealFlight 9 simulator also allows you to record your flights for later playback – complete with audio voiceovers. You can even share your flights with friends and fellow pilots.

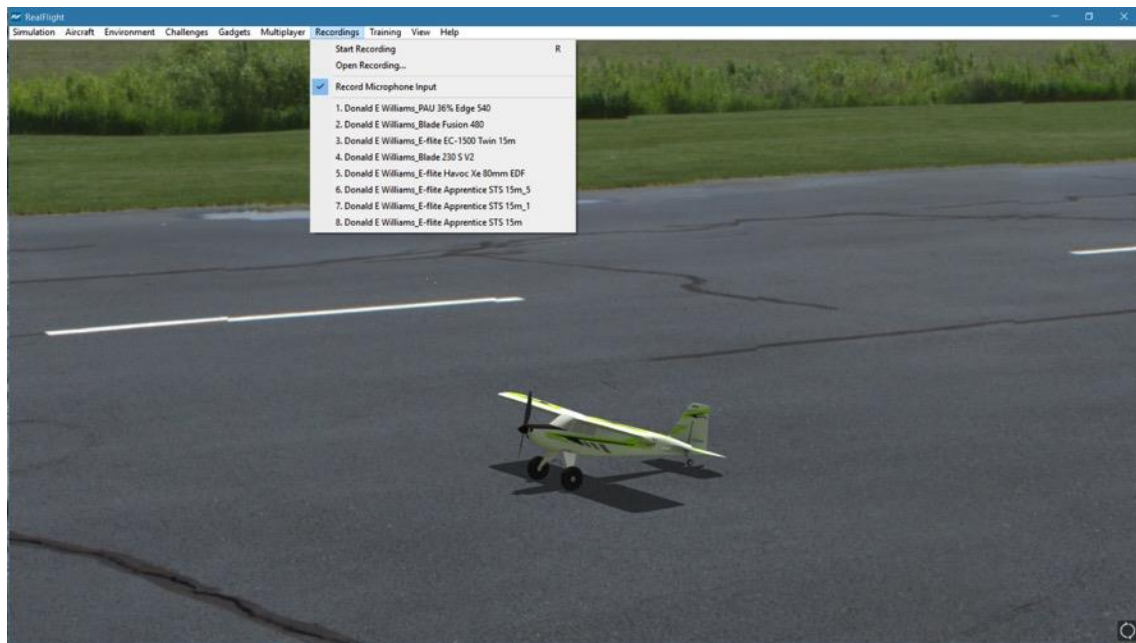

## Start Recording

Click on the **Recording** menu followed by the **Start Recording** menu item. RealFlight 9 will start recording your flight immediately. An on-screen message will confirm that the recording has started.

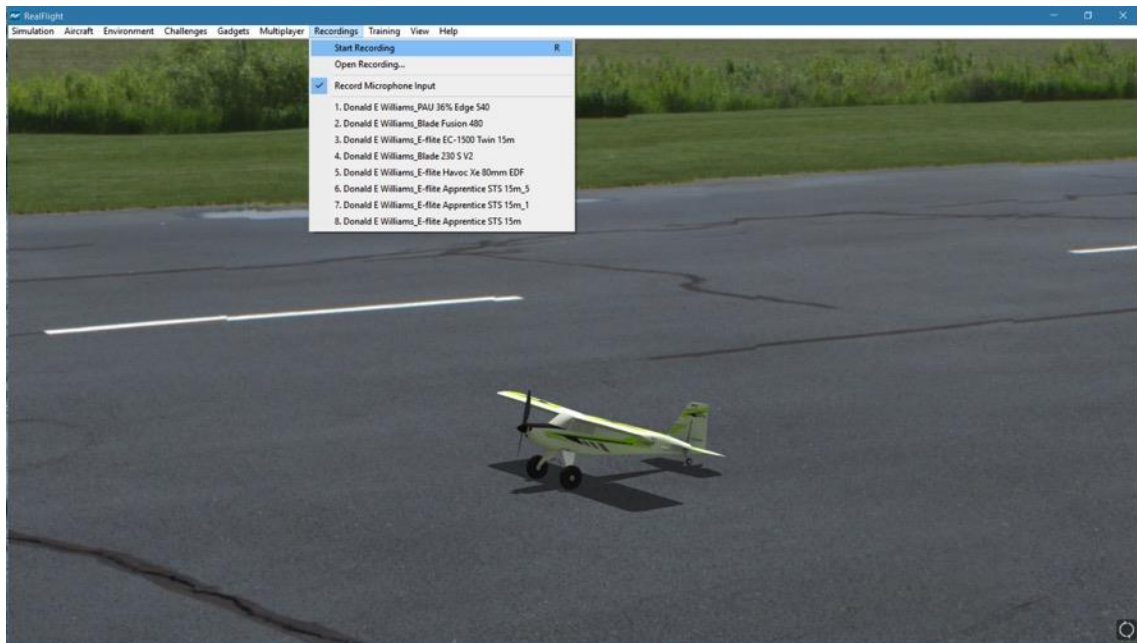

RealFlight will continue recording your flight until you select the **Stop Recording** menu item or press 'R' again to stop recording.



## Stop Recording

The Stop Recording menu item is not visible until the Start Recording menu item activates. To stop the recording of your flight at any time, click the **Recording** menu title, followed by the **Stop Recording** option. RealFlight 9 will stop recording at this time. RealFlight 9 automatically saves all recordings for playback later. For information on how to delete a recording, please see the Open Recording... section which follows.

When RealFlight 9 stops recording, an on-screen message appears which indicates the default name of the recording that has just been completed. For information on how to change the name of a recording, please see the Open Recording... section which follows.

## Open Recording...

This menu item allows you to access the recording files. It also allows you to perform a variety of modifications to the files such as renaming them or deleting them. To access the recordings, click the **Recording** menu title followed by the **Open Recording...** menu item.

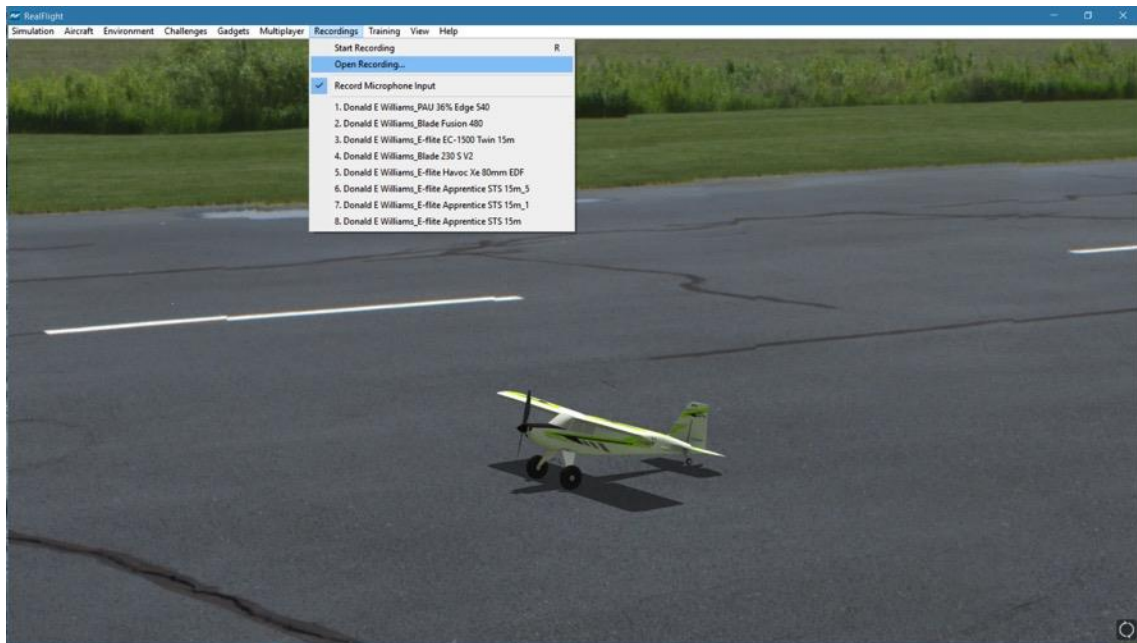

To open a recording, click on the file name. Next, click on the **Open** button. Alternatively, you may double-click on the file. Regardless of which method you use, this will start RealFlight's Playback Gadget. For more information on the Playback Gadget, please refer to the information below.

If you wish to rename the recording, simply right click on the respective recording, select rename from the drop-down menu and rename the file.

To delete a recording, right click on the recording file and select **Delete** from the pull-down list.

## Playback Gadget-

When you open a recording, RealFlight 9's playback gadget appears on the screen. This gadget allows you to control the playback of the recordings using simple mouse commands. It features DVD-like controls that start, stop, and pause the playback. It is also possible to modify the playback gadget.



If you do not wish to view the playback information, double-click the **title bar** of the display box. This will hide the information. To view it once again, simply double-click the **title bar** again.

To modify the size of the playback gadget display, position the cursor over the lower right corner of the frame. Using the mouse, drag the frame according to your wishes. Dragging the frame to the right or left increases or decreases the width of the gadget, respectively.

Clicking on the 'X' in the viewport's title tab removes it from the screen and exits the playback.

#### Loop Play-

The arrows that form a circle cause the recording to loop (i.e., play continuously). The continuous loop is activated when the arrows are illuminated. To stop the looping, click on the loop button again.



#### Look at Recording-

Click on the 'eye' to look at the respective Recording. This causes the camera to treat the recording as its target object, rather than your aircraft. If you are looking at a different aircraft than the recording and wish to watch the recording, click the 'eye' button.



#### Left/Right Arrows-

The left and right arrows skip back (left) or skip forward (right) in the recording. Alternatively, you may click on the position indicator, hold the mouse button and drag the indicator to the desired position.

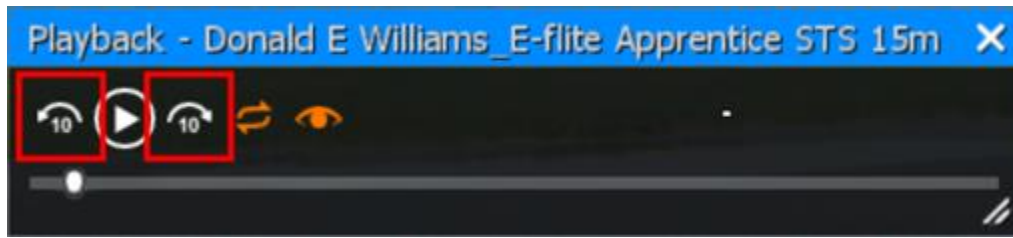

### Playback/Pause-

If the recording is paused, the playback button will be the single arrow pointing to the right. To resume playback of the recording, click this arrow.



If the recording is playing, the playback button will switch to a pause button. To pause playback, press this button. You may continue at any time by pressing the playback button once again.

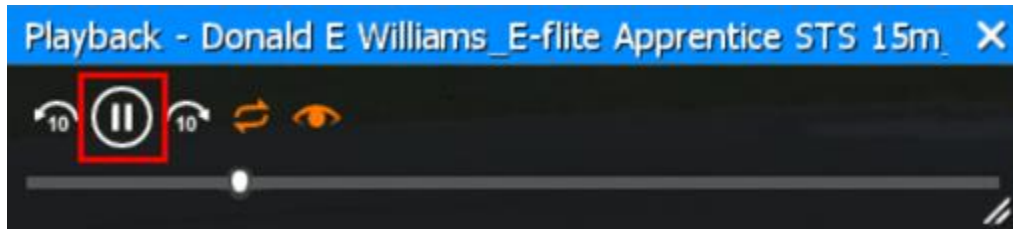

### Position of Recording-

The slider bar and position indicator are used to track the progress of the recording playback.

It is also possible to use the position indicator to select the point at which you wish the recording to begin playing. Using the mouse drag, position the slider bar to the position desired.

## Record Microphone Input

RealFlight 9 also allows you to add your voice or other audio to the recordings. If selected, the Record Microphone Input menu item activates and allows you to record audio input to accompany your recording.

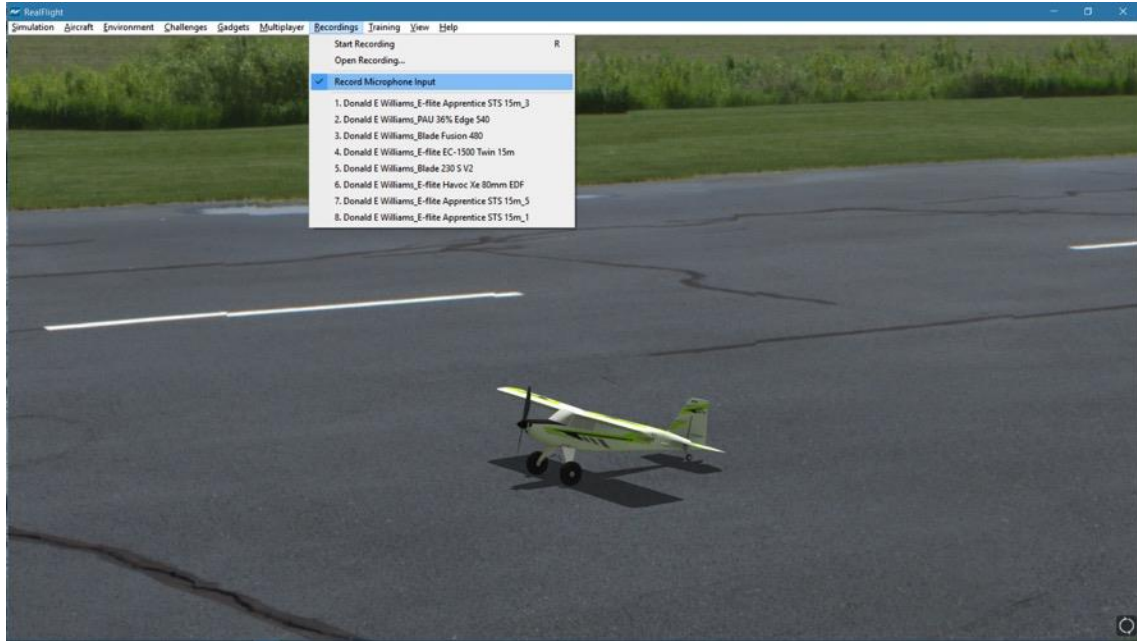

Adding your voiceover to the recordings is a fantastic way to create personalized training lessons. This feature presents you with the ability to create your own Virtual Flight Instructions that you can share with other RealFlight 9 owners around the world!



## Recordings MRU

If you have previously selected a recording, you will note that it appears on a list in the Recordings menu title. Lists such as this are commonly referred to as Most Recently Used, or MRU lists. The MRU list is limited to the eight most recently selected recordings. If you wish to view one of these recordings simply click on the name of the recording and it will begin.

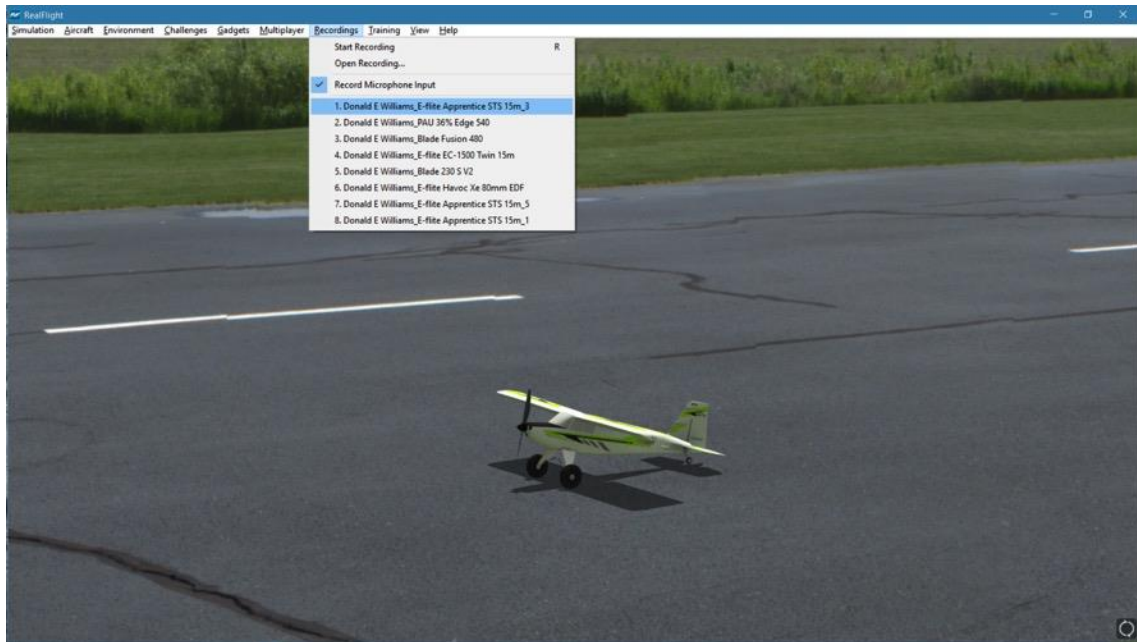

## Training Menu

*PRACTICE MAKES PERFECT. REALFLIGHT'S TRAINING AIDS MAKE PRACTICING A LITTLE MORE ENJOYABLE.*

**R**ealFlight 9 Horizon Hobby Edition offers a number of training aids. These training aids are designed for modelers of all skill levels.

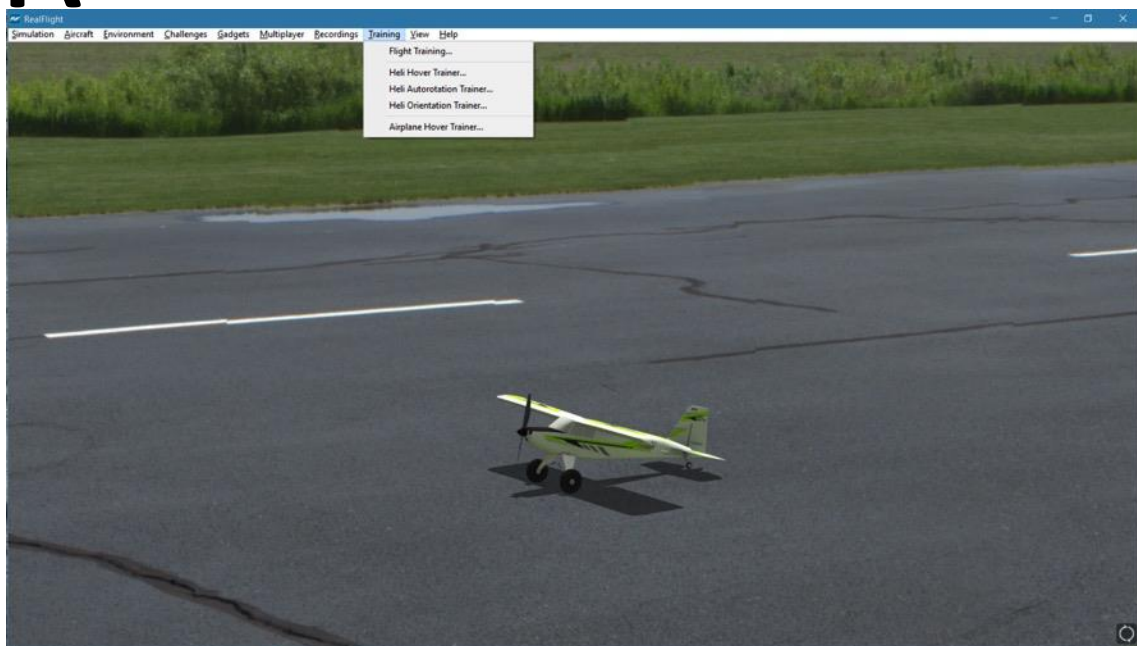

Helicopter pilots will benefit from the Heli Hover Trainer, Heli Autorotation Trainer, and the Heli Orientation Trainer. The Heli Hover Trainer and Heli Orientation Trainer offer modelers the chance to practice their stick control and helicopter attitude recognition.

Airplane modelers will benefit from the Airplane Hover Trainer. Further, entry-level airplane modelers will also benefit from the **new** Flight Training module that has been incorporated in the RealFlight 9 Flight Simulator. As the name suggests, this module includes a number of flight training segments designed to introduce modelers to RC flight and to overcome any potential apprehensions or fears. Our instructor will teach you step-by-step, how to takeoff, fly around and land safely using E-flite's Apprentice STS airplane.

RealFlight 9 also makes it easy to access some of the previous flight training segments as well. The Classic segment includes a multitude of lessons for both helicopter and airplane pilots covering the gamut of RC flight- from basic skills through advanced aerobatics; it's all there and ready to advance your skillset.

## Flight Training

The Flight Training segment of the Training menu, as noted previously, is a great introduction to RC for newcomers, as well as the ideal way for seasoned veterans to either advance their skills, or fine-tune existing ones.

To start the training, select the **Flight Training** menu item from the Training menu. This will lead you to the Flight Training menu selections.

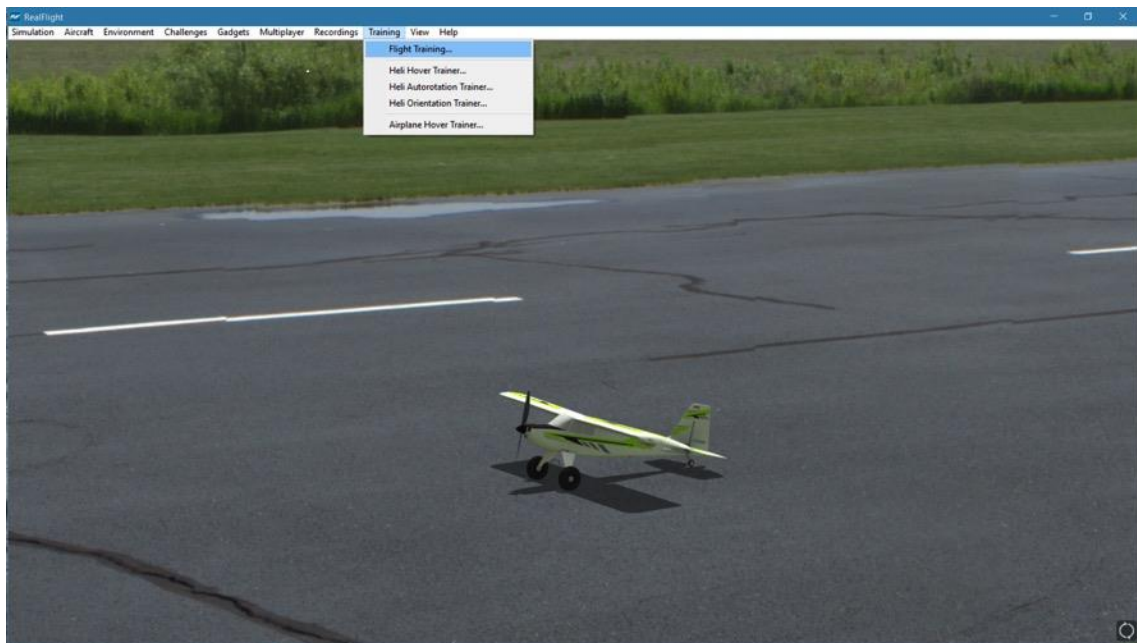

The Flight Training menu item contains several filter options. The filter option selected, as well as any previously completed flight training lessons, may determine lesson availability.

If the New filter is selected, this will bring forth the flight training that has been added to the RealFlight 9 offering. The Classic filter includes content that was previously offered through past iterations of the RealFlight simulation.

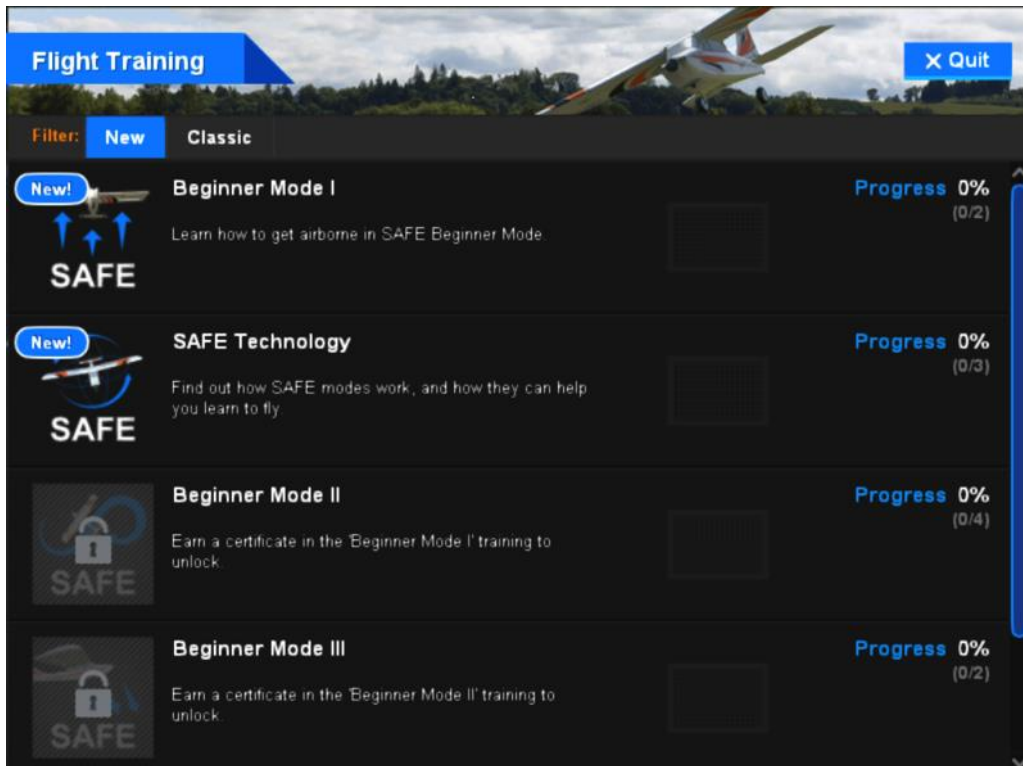

## New Flight Training

The New Flight Training filter contains a variety of flight lessons from our expert flight instructor that will take newcomers to the hobby through all facets of entry-level flight. For example, the first lesson offered teaches modelers how to properly taxi the aircraft in preparation for takeoff. We then build upon the lessons sequentially with the final lesson putting it all together to takeoff, fly around and then landing appropriately just as it would be done at the local flying field.

If you have not completed any of the New Flight Training sessions, selecting this option will initially allow access to the Beginner Mode I and SAFE Technology lessons. The goal of the Flight Training module is to provide entry-level modelers with a solid foundation from which to grow and expand their capabilities. Once these lessons have been completed, with an acceptable score, additional lessons will become available to the modeler.

To access a Flight Training lesson, mouse click on the desired lesson. Note: if a lesson is grayed out with the padlock image in the iconic representation, then this particular lesson is not yet available to you. Please complete the previous lessons to unlock accordingly.

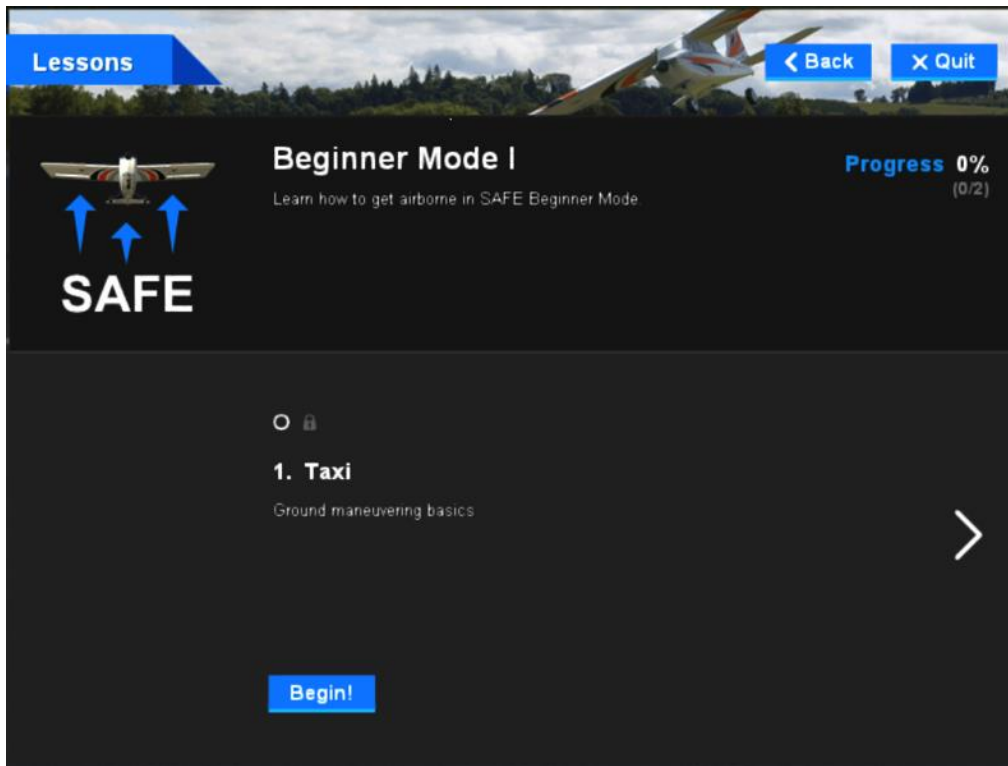

After you've selected the desired lesson, you will note several areas of interest. For example, the header of the lesson includes the overall goal for this module. For example, if Beginner Mode I has been selected the overall goal is to ensure that the modeler is comfortable getting airborne with SAFE in the Beginner Mode.

Further, the specific lesson at hand is described accordingly. In our example, lesson 1 is to ensure that the modeler is able to taxi the aircraft appropriately to place themselves in proper position for a takeoff.

Click **Begin!** to start the Lesson accordingly.



If applicable, a Flight Modes graphical indication will appear on screen as well. This indicator will exemplify the current flight mode of the Instructor’s aircraft. Should the Instructor alter the flight mode within the lesson, the graphic will also change accordingly.

Further, an on-screen radio will indicate the Instructor’s stick movements as well as any switch positions, etc. This visual representation will greatly assist in the understanding of any desired inputs as well as the amount of input necessary to achieve a given response from the aircraft.

When the Lesson is finished, a Lesson Complete notification will appear in the upper right corner of the screen. Click **Finish** to return to the main menu.

Progress for a given lesson is indicated as a percentage to the right of the *progress* indicator. Furthermore, the number of lessons within a segment is included below this progression indication. In our example, there are two lessons thus completing one of the two would produce a progress indicator of 50%.

If another lesson is available in the selected module, click the arrow indication on the side of the screen accordingly, to access.

To start the desired lesson, click the **Begin!** button at the bottom of the screen. This will lead to the next dialog screen. If you’ve completed a lesson, the date of completion will be noted accordingly. Mouse click the **Begin!** once again to start the training session.

### Playback Gadget Bar-

With the flight training lesson open, RealFlight’s playback gadget bar will appear at the top of the screen. There are a number of controls and options included on this gadget bar; each will be identified and explained below in a separate section for ease of reference.

### Playback Gadget-

This gadget allows you to control the playback of the recordings using the mouse. For example, clicking the arrow that is facing to the left will rewind the flight lesson and start from the beginning. If you want to review a segment of the lesson, clicking the semi-circular arrow with the 10 beneath this will rewind to the previous 10 seconds. Further, if you wish to pause a lesson when it is playing, simply click the 'Pause' button.

The center portion of the playback gadget indicates the overall length of a given lesson as well as the current recording position within this lesson.

Additionally, it is possible to use the position indicator on the recording's slider bar to move the recording to the desired starting point. To do so, use the mouse drag to position the slider bar to the position desired then release.

### Try It/Watch Gadget-

Represented by the transmitter icon and the words 'Try it!' or 'Watch', this gadget determines whether or not the user wishes to try the lesson themselves.

If the watch appears on screen, it is fairly self-explanatory, the modeler will simply be watching (and listening) to the Instructor's explanation of the lesson selected.

However, if the modeler mouse clicks on Try It!, his/her aircraft will appear on-screen near the Instructor's model. This will enable the modeler to mimic the flight control inputs, etc. so that they may practice the maneuver for themselves. Of course, the Instructor's aircraft is still active as well so there will be a visual representation from which to reference.

### Lessons-

Mouse clicking the Lessons icon will take you back to the lesson selection menu item of the Flight Training screen once again; enabling you to continue forward with additional lessons or to press the **Quit** button accordingly.

### Classic Flight Training-

As mentioned previously, the Classic Flight Training module includes a variety of lessons that had been incorporated into previous RealFlight offerings from a variety of pilots. The appearance may be a bit dated, however, the foundational training is still valid today.

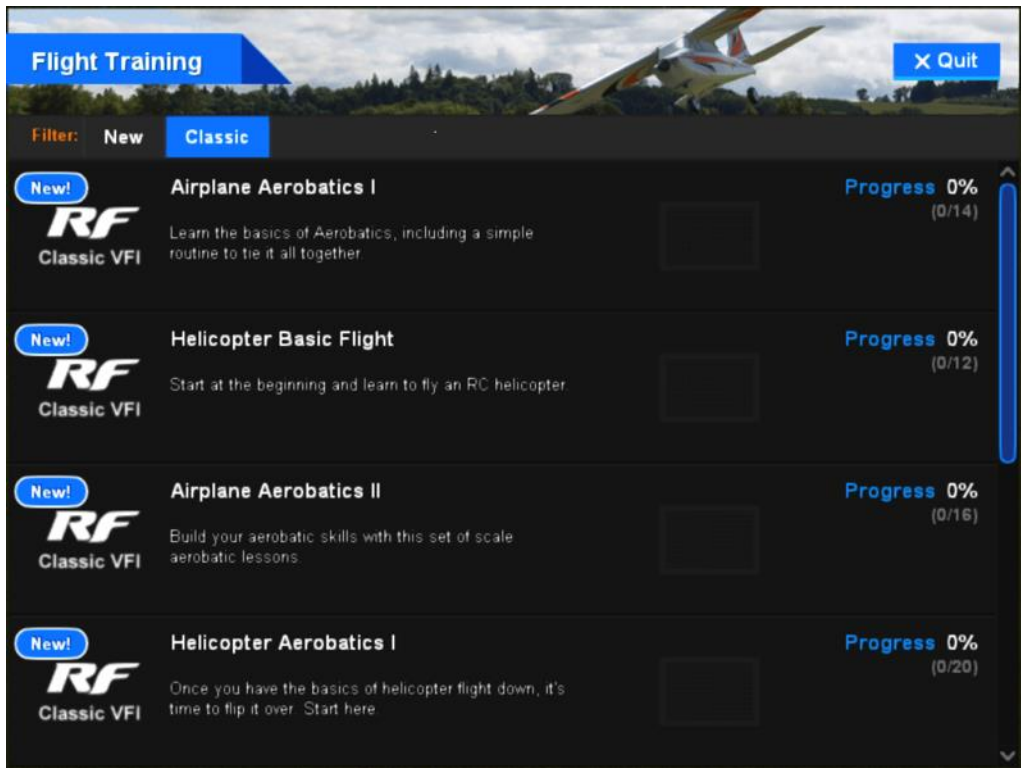

The menu items (e.g., Playback Gadget, etc.) are identical to those utilized in the New Flight Training segments noted previously. For additional information pertaining to these items, please reference the information above.

The lessons offered in the Classic Flight Training have been further grouped into relevant categories. For example, the Airplane Aerobatics I session includes 14 individual lessons that target some of the entry-level maneuvers commonly taught to pilots that have progressed beyond a basic skillset. Similarly, the Airplane Aerobatics II lessons will go beyond that taught in the Airplane Aerobatics I.



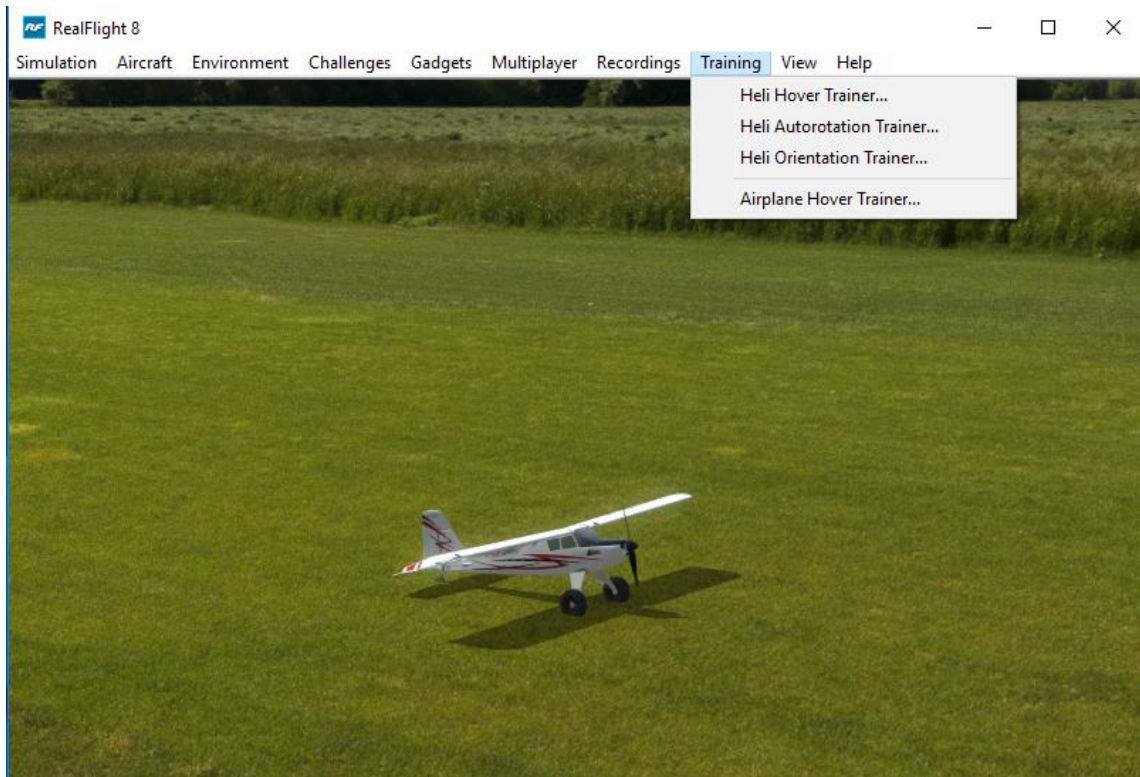

## Heli Hover Trainer

The Heli Hover Trainer offers you a great way to learn how to precisely control a helicopter in a hover. With the Heli Hover Trainer, you pick which channel, or channels you wish to control and RealFlight will take care of the rest for you. You'll also have options to determine the model's orientation, perimeter dimensions, and more.

To start the trainer, click **Heli Hover Trainer...** menu item from the **Training** menu. The trainer will start automatically.

A welcome dialog will first appear to explain the goals of this trainer as well as offer a few tips. If you do not wish to see this dialog screen again for each time you load this trainer, simply click the **Don't show this message again** checkbox at the bottom, then click **Go**.

Following the welcome dialog, the get ready dialog screen will appear. This screen will explain what you are required to do for this trainer. There is also a checklist that you should follow before you proceed. If an item in the checklist is properly adjusted, or correctly positioned, the Ready light will illuminate. Otherwise, the Ready light will be dim, and the function on the controller pictured to the left will blink indicating what needs to be done.

The get ready dialog is a great way to prepare for the trainer. Once you have successfully run through the trainer a few times and no longer wish to see this dialog, simply click the checkbox labeled **Don't show this message again** and then click **Go**.

You'll notice a circle on the ground. This circle represents the training boundary or perimeter. If your helicopter ventures beyond the boundary's outer perimeter, it will break apart and the session will begin once again. The smaller circle within the boundary's perimeters represents the true center of the boundary. You'll also note an 'X' mark within the boundary; the 'X' represents the current location of your helicopter. The goal is to control the helicopter in a stable hover, keeping it as close to the center of the circle as possible.

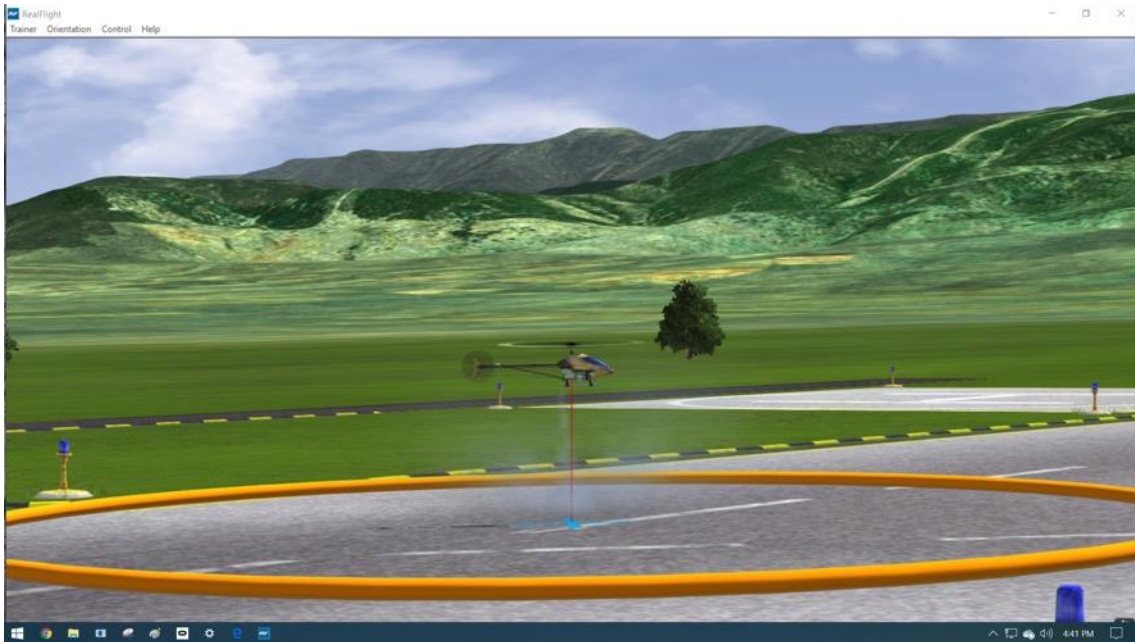

## Trainer Menu-

The Trainer menu contains the following menu items:



### Reset Aircraft-

If you crash or fly outside the circle, there are three ways to reset the aircraft:

1. Press the **Reset** button on the InterLink DX controller. This is probably the fastest and simplest method.
2. Press the keyboard's space bar.
3. Click the **Reset Aircraft** menu item.

### Boundary-

The Boundary menu item allows you to change the size of the circle, or eliminate it altogether. To change the size of the boundary, select the **Boundary** menu item from the **Trainer** menu. A drop-down menu will appear with the following options.

- None – Eliminate the boundary circle.
- Small – Creates a small circle.
- Medium – Creates a medium-sized circle; this is the default setting.
- Large – Creates a large circle.

### Crashes-

After a crash, RealFlight may automatically reset your helicopter for you, if so desired. This option is on by default. If you would prefer to turn this option off, select the **Crashes** menu item, then select the **Automatically Reset Aircraft**. If a checkmark appears next to this menu item, then this feature is activated. If the checkmark does not appear, it is not active.

If Automatically Reset Aircraft is enabled, you may adjust how quickly the reset happens. To adjust this delay, select the **Crashes** menu item followed by the **Reset Delay** menu item. Four options will be available to you:

- None – No delay will be set. The aircraft will reset immediately.
- Short – The aircraft will reset approximately one second after it crashes.
- Medium – The aircraft will reset approximately three seconds after it crashes.
- Long – The aircraft will reset approximately six seconds after it crashes.

### Exit-

If you wish to leave the Heli Hover Trainer and return to the simulator, select the **Exit** menu item.

## Orientation Menu-

The Orientation menu allows you the option to select the position and attitude of the heli when the session begins or the helicopter is reset.



A checkmark will appear next to the currently selected orientation. The options available are:

- Random Upright – The heli will start in the upright position, but it will randomly face either to the right, left, nose out, or nose in.
- Random Inverted – The heli will start in the inverted position, but it will randomly face either to the right, left, nose out, or nose in.
- Nose Out – The heli will start upright, facing nose out. This option is the best selection for beginning heli pilots.
- Nose In – The heli will start upright, facing nose in.
- Left – The heli will start upright, facing to the left.
- Right – The heli will start upright, facing to the right.
- Nose Out Inverted – The heli will start inverted, facing nose out.
- Nose In Inverted – The heli will start inverted, facing nose in.
- Left Inverted – The heli will start inverted, facing to the left.
- Right Inverted – The heli will start inverted, facing to the right.

## Control Menu-

The Control menu allows you to select which channel or channels you will control. All other channels are controlled by RealFlight, allowing you to learn just the controls you wish and adding more as you become more comfortable and confident in your skills.



A checkmark will appear in the menu next to the currently selected item. Your options are:

- Pitch Only – You control only the pitch of the heli. RealFlight will control the roll, yaw, and throttle.
- Roll Only – You control only the roll of the heli. RealFlight will control the pitch, yaw, and throttle.
- Yaw Only – You control only the yaw of the heli. RealFlight will control the roll, pitch, and throttle.
- Throttle Only – You control only the throttle of the heli. RealFlight will control the roll, yaw, and pitch.
- Throttle, Pitch – You control both the throttle and pitch of the heli. RealFlight will control the roll, and yaw.
- Throttle, Roll – You control both the throttle and roll of the heli. RealFlight will control the pitch, and yaw.
- Throttle, Yaw – You control both the throttle and yaw of the heli. RealFlight will control the roll, and pitch.
- Throttle, Pitch, Roll, Yaw – You control all channels for the heli.

## Help-

If you wish to display the welcome and get ready dialog screens again, select **Show Training Dialogs** from the Help menu.



## Heli Autorotation Trainer

Every helicopter pilot will tell you that one of the most important things to learn is how to properly perform an autorotation in case your model should experience a motor/engine loss of power. This Heli Autorotation Trainer offers you a great way to learn this maneuver.

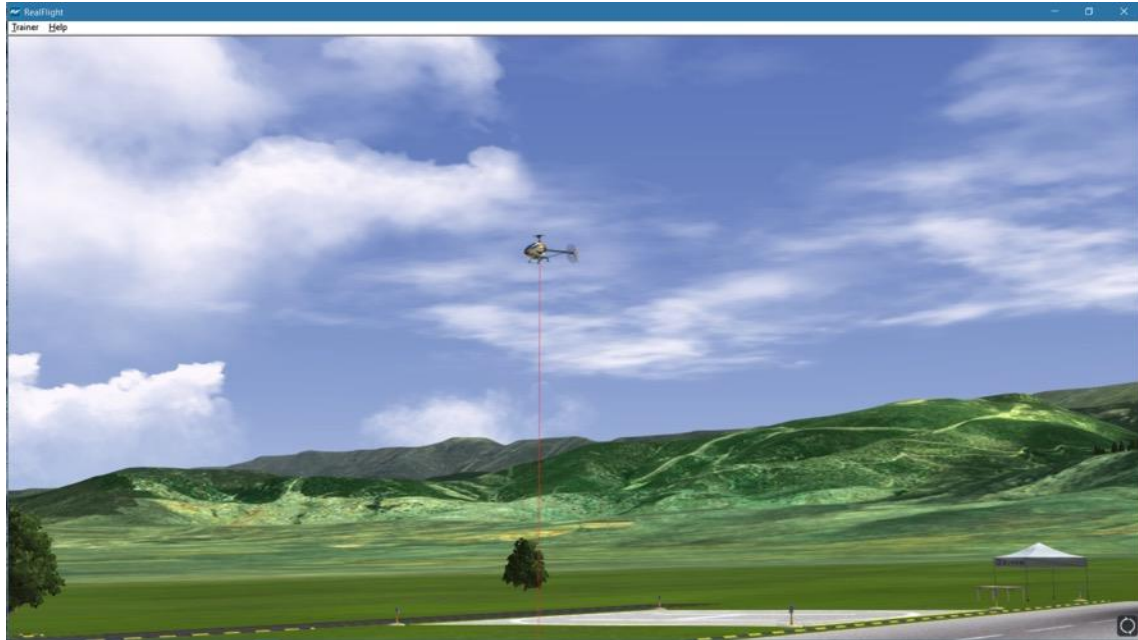

To start the trainer, click **Heli Autorotation Trainer...** menu item from the **Training** menu. The trainer will start automatically.

A welcome dialog will first appear to explain the goals of this trainer and offer a few tips. If you do not wish to see this dialog screen again each time you load this trainer, simply click the **Don't show this message again** checkbox at the bottom, then click **Close**.

Following the welcome dialog, the get ready dialog screen will appear. This screen will explain what you are required to do for this trainer. There is also a checklist that you should follow before you proceed. If an item in the checklist is set, the Ready light will illuminate. Otherwise, the Ready light will be dim, and the function on the controller pictured to the left will blink indicating what needs to be done.

The get ready dialog is a great way to prepare for the trainer. Once you have successfully run through the trainer a few times and no longer wish to see this dialog, simply click the checkbox labeled **Don't show this message again** and then click **Go**.

You'll notice that the heli appears in the air with a line below it drawn towards the ground. On the ground is a boundary circle in which you must land.



## Trainer Menu-

The trainer Menu contains the following menu items:



### Reset Aircraft-

If you crash, there are three ways to reset the aircraft:

1. Press the **Reset** button on the InterLink DX controller. This is probably the fastest and simplest method.
2. Press the keyboard's space bar.
3. Click the **Reset Aircraft** menu item.

### Boundary-

The Boundary menu item allows you to change the size of the circle or eliminate it altogether. To change the size or the boundary, select the **Boundary** menu item from the **Trainer** menu. A drop-down menu will appear with the following options:

- None – Eliminates the boundary circle.
- Small – Creates a small circle.
- Medium – Creates a medium-sized circle.
- Large – Creates a large circle.

### Initial Altitude-

This sub-menu item allows you to adjust the altitude from which you will start the autorotation. A low altitude will offer less time for you to make adjustments to your landing, however, it is good to practice emergency autorotations at all altitudes.

There are three options available:

- Low – While a lower altitude offers less time for input, the inertia will have less time to diminish as well.
- Medium – Allows for a mid-level autorotation.
- High – The helicopter will start at a higher altitude. Thus, the pilot will have to compensate accordingly to ensure a safe autorotation landing.

### Approach Position-

The Approach Position sub-menu allows you to adjust the initial location of the heli, from right to left, with middle directly in front of the landing zone. You may also choose Inverted from this sub-menu to practice maneuvering the heli back to an upright position before landing during the autorotation.

### Crashes-

After a crash, RealFlight may automatically reset your aircraft for you, if so desired. This option is on by default. If you would prefer to turn this option off, select the **Crashes** menu item, then select the **Automatically Reset Aircraft**. If a checkmark appears next to this menu item then this feature is activated. If the checkmark does not appear, it is not active.

If Automatically Reset Aircraft is enabled, you can adjust how quickly the reset happens. To adjust this delay, select the **Crashes** menu item followed by the **Reset Delay** menu item. Four options will be available to you:

- None – No delay will be set. The aircraft will reset instantaneously.
- Short – The aircraft will reset approximately one second after it crashes.
- Medium – The aircraft will reset approximately three seconds after it crashes.
- Long – The aircraft will reset approximately six seconds after it crashes.

### Exit-

If you wish to leave the Heli Hover Trainer and return to the simulator, select the **Exit** menu item.

## Help-

If you wish to display the welcome and get ready dialog screens again, select **Show Training Dialogs** from the Help menu.



## Heli Orientation Trainer

As you become more proficient with hovering a helicopter, you can test your skills with the Heli Orientation Trainer. The Heli Orientation Trainer challenges you to keep your helicopter in the same location as the trainer helicopter. As you succeed in doing so the trainer helicopter will move and the level of difficulty will increase.

To start the trainer, select the **Heli Orientation Trainer** menu item from the **Training** menu.

The Heli Orientation Trainer has a number of different levels, each with an increasing degree of difficulty greater than the previous. To pass a level you must hover your helicopter in close proximity to the trainer helicopter, mimicking the attitude, etc. of the trainer helicopter. As you do so, the trainer helicopter will turn from blue to red and the progress bar at the top of the screen will increase indicating that your task is nearly complete.



In the upper right corner, a countdown timer is visible. This is the remaining amount of time allotted for you to fill the progress bar and complete the task. If you fail to do so, both the timer, and the progress bar will reset to zero. You must begin once again.

The number displayed in the upper left corner indicates the number of locations the trainer helicopter will stop for the current level. It will also indicate how many of these locations you have completed. For example, if it displays 1/3, you have successfully completed one spot out of three for the current level.

As you advance to the next level, you may be responsible for controlling more channels, the allotted time might also decrease, and the trainer heli will stop in more locations. You might also experience any combination of these circumstances as the difficulty increases.

## Heli Orientation Menu-

The Heli Orientation menu is the only menu accessible while the trainer is running. Two options are available in the Heli Orientation menu:

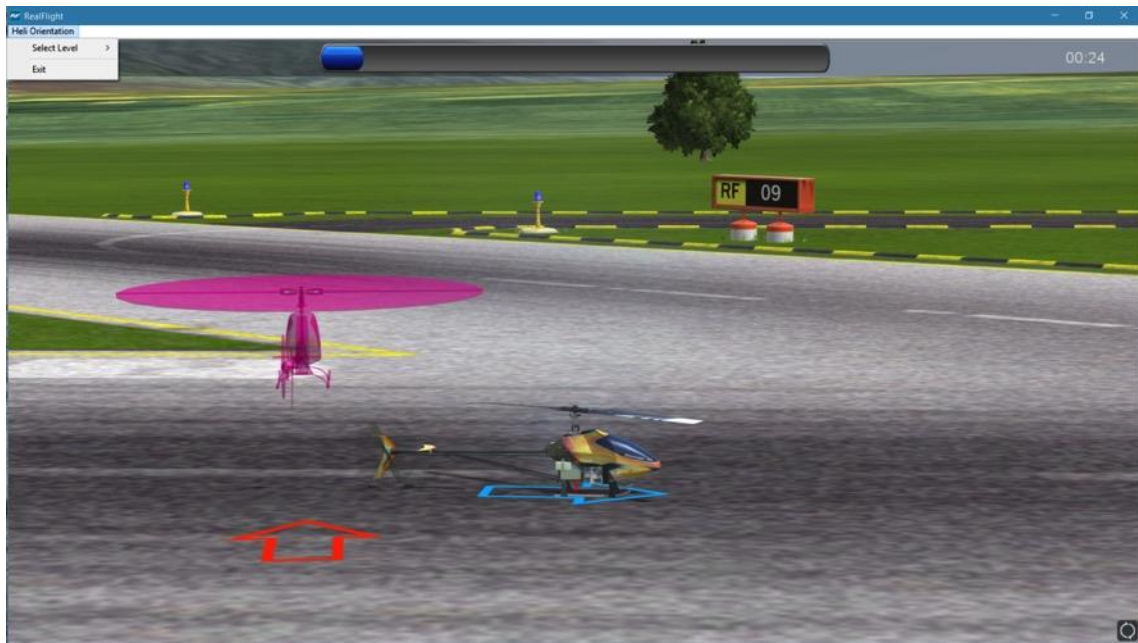

### Select Level-

A drop-down menu will display the levels available to you. For example, if you have only progressed to Level 2, you will not be able to access Level 3 or higher in this menu.

A checkmark will appear next to the level you are currently flying.

### Exit-

To return to the simulator, select **Exit** to leave the Heli Orientation Trainer.

## Airplane Hover Trainer

The Airplane Hover Trainer offers you a great way to learn how to control an aerobatic airplane in a torque roll. With the Airplane Hover Trainer, you pick which channel or channels you wish to control. RealFlight automatically controls the rest.

To start the trainer, click the **Airplane Hover Trainer...** menu item from the **Training** menu. The trainer will start automatically.



A welcome dialog will appear to explain the goals of this trainer and offer a few tips. If you do not wish to see this dialog screen again each time you load this trainer, simply click the **Don't show this message again** checkbox at the bottom, then click **Close**.

Following the welcome dialog, the get ready dialog screen will appear. This screen will explain what you are required to do for this trainer. There is also a checklist that you should follow before you proceed. If an item in the checklist is properly adjusted, the Ready light will illuminate. Otherwise, the Ready light will be dim, and the function on the controller pictured to the left will blink indicating what needs to be done.

The get ready dialog is a great way to prepare for the trainer. Once you have successfully run through the trainer a few times and no longer wish to see this dialog, simply click the checkbox labeled **Don't show this message again** and then click **Go**.

Within the trainer, you'll notice a circle on the ground. This circle represents the training boundary, or perimeter. If your airplane ventures beyond this boundary, it will break apart and the session will begin once again. You'll also note an 'X' mark within the boundary that represents the current location of your airplane. The goal is to control the airplane in a stable hover; keeping it as close to the center of the circle as possible.

## Trainer Menu-

The Trainer menu contains the following menu items:

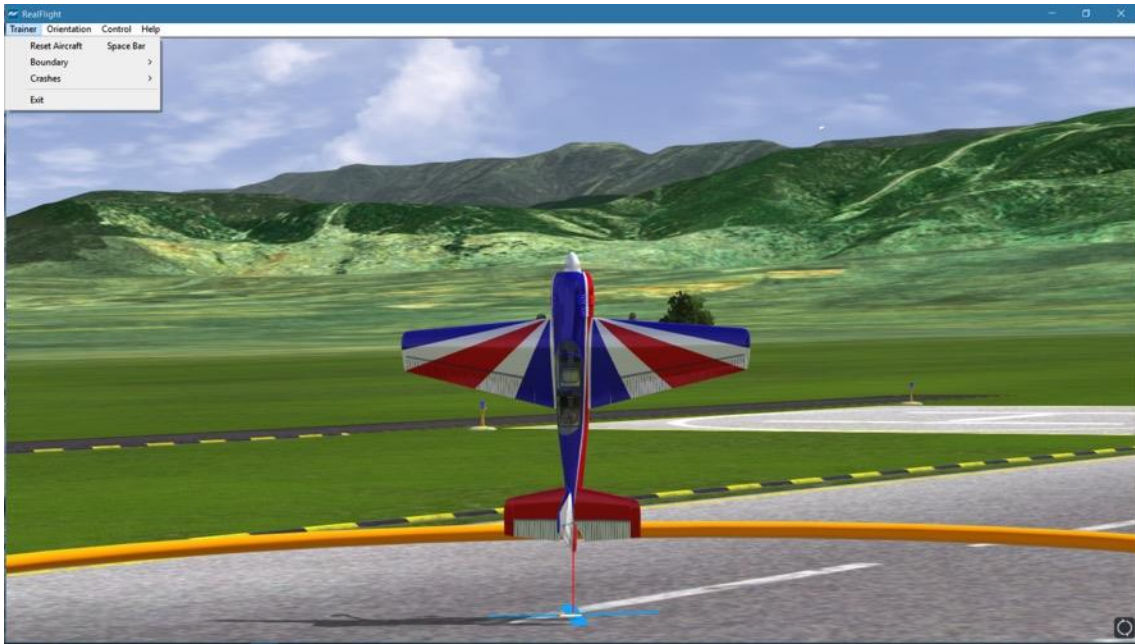

### Reset Aircraft-

If you crash or fly outside the circle, there are three ways to reset the aircraft:

1. Press the **Reset** button on the InterLink DX controller. This is probably the fastest and simplest method.
2. Press the keyboard's space bar.
3. Click the **Reset Aircraft** menu item.

### Boundary-

The Boundary menu item allows you to change the size of the circle, or eliminate it altogether. To change the size or the boundary, select the **Boundary** menu item from the **Trainer** menu. A drop-down menu will appear with the following options:

- None – Eliminates the boundary circle.
- Small – Creates a small circle.
- Medium – Creates a medium-sized circle.
- Large – Creates a large circle.

### Crashes-

After a crash, RealFlight may automatically reset your aircraft for you, if so desired. This option is on by default. If you would prefer to turn this option off, select the **Crashes** menu item, then select the **Automatically Reset Aircraft**. If a checkmark

appears next to this menu item then this feature is activated. If the checkmark does not appear, it is not active.

If **Automatically Reset Aircraft** is enabled, you can adjust how quickly the reset happens. To adjust this delay, select the **Crashes** menu item followed by the **Reset Delay** menu item. Four options will be available to you:

- None – No delay will be set. The aircraft will reset instantaneously.
- Short – The aircraft will reset approximately one second after it crashes.
- Medium – The aircraft will reset approximately three seconds after it crashes.
- Long – The aircraft will reset approximately six seconds after it crashes.

#### **Exit-**

If you wish to leave the Airplane Hover Trainer and return to the simulator, select the **Exit** menu item.



## Orientation Menu-

The Orientation menu allows you the option to select the position and attitude of the airplane when the session begins or the airplane is reset.

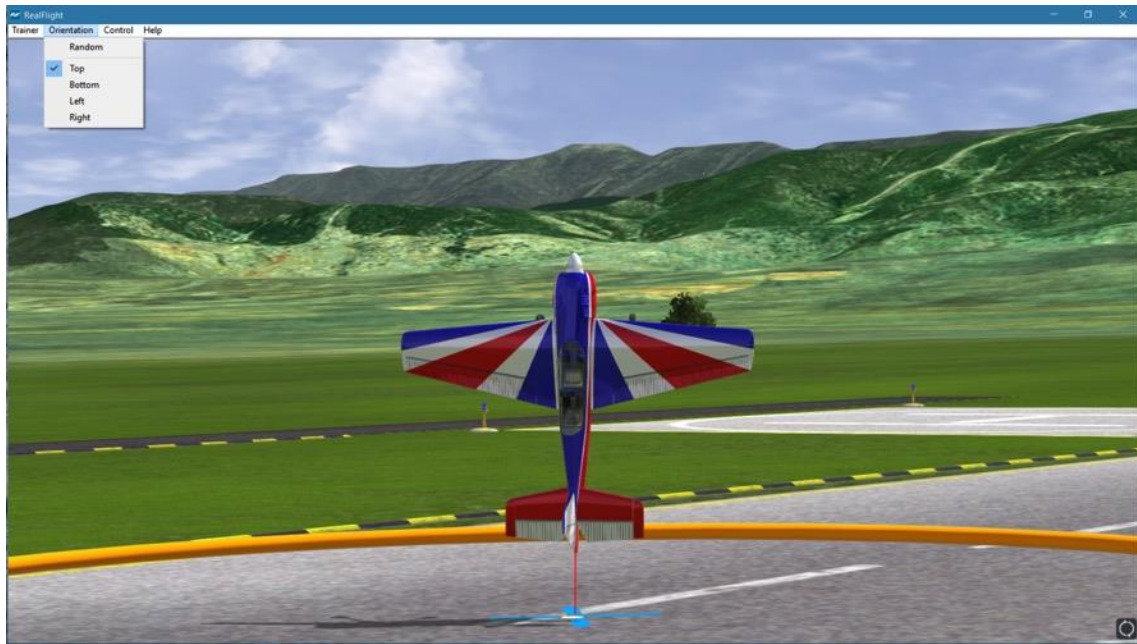

A checkmark will appear next to the currently selected orientation. The options available are:

- Random – The airplane will start in a random position, with the top, bottom, left side or right side facing you.
- Top – The airplane will start with the top of the aircraft facing you.
- Bottom – The airplane will start with the bottom of the aircraft facing you.
- Left – The airplane will start with the left side of the aircraft facing you.
- Right – The airplane will start with the right side of the aircraft facing you.

## Control Menu-

The Control menu allows you to select which channel or channels to control. The remaining channels are controlled by RealFlight, allowing you to learn just the controls you wish and adding more as you become more comfortable and confident.

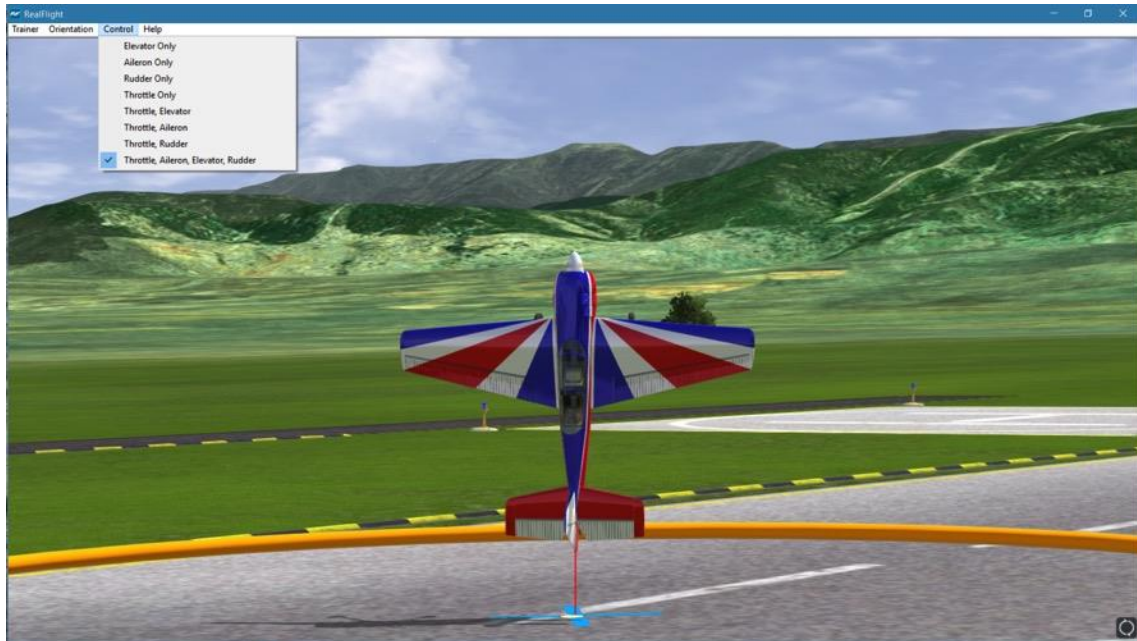

A checkmark will appear in the menu next to the currently selected item. Your options are:

- Elevator Only – Check this to control only the elevator of the aircraft. RealFlight will control the throttle, ailerons, and rudder for you.
- Aileron Only – Check this to control only the ailerons of the aircraft. RealFlight will control the throttle, elevator, and rudder for you.
- Rudder Only – Check this to control only the rudder of the aircraft. RealFlight will control the throttle, ailerons, and elevator for you.
- Throttle Only – Check this to control only the throttle of the aircraft. RealFlight will control the elevator, ailerons, and rudder for you.
- Throttle, Elevator – Check this to control the throttle and elevator of the aircraft. RealFlight will control the ailerons and rudder for you.
- Throttle, Aileron – Check this to control the throttle and ailerons of the aircraft. RealFlight will control the elevator and rudder for you.
- Throttle, Rudder – Check this to control the throttle and rudder of the aircraft. RealFlight will control the elevator and ailerons for you.

- Throttle, Aileron, Elevator, Rudder – Check this to control all four channels. You will not receive any assistance from RealFlight.

## Help-

If you wish to display the welcome and get ready dialog screens again, select **Show Training Dialogs** from the Help menu.

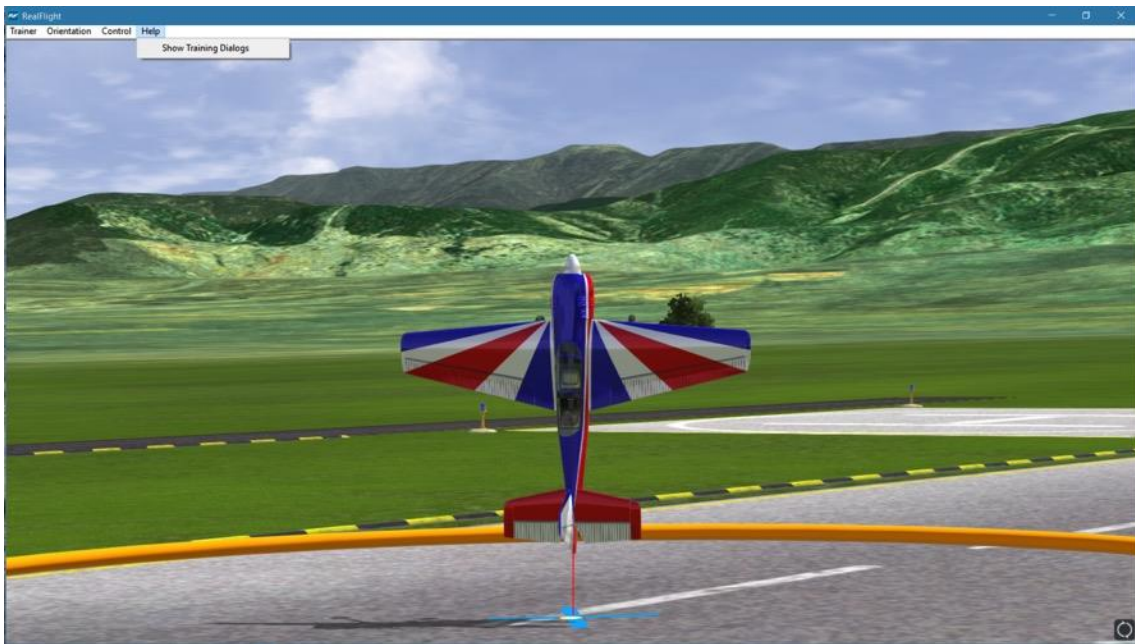

## View Menu

*ADJUST YOUR VANTAGE POINT, CHANGE YOUR LOCATION, ENABLE EFFECTS, AND MORE.*

This menu allows you to adjust the various view-related features and functions of the simulation. The View menu adjusts what you are looking at and where you are looking from.

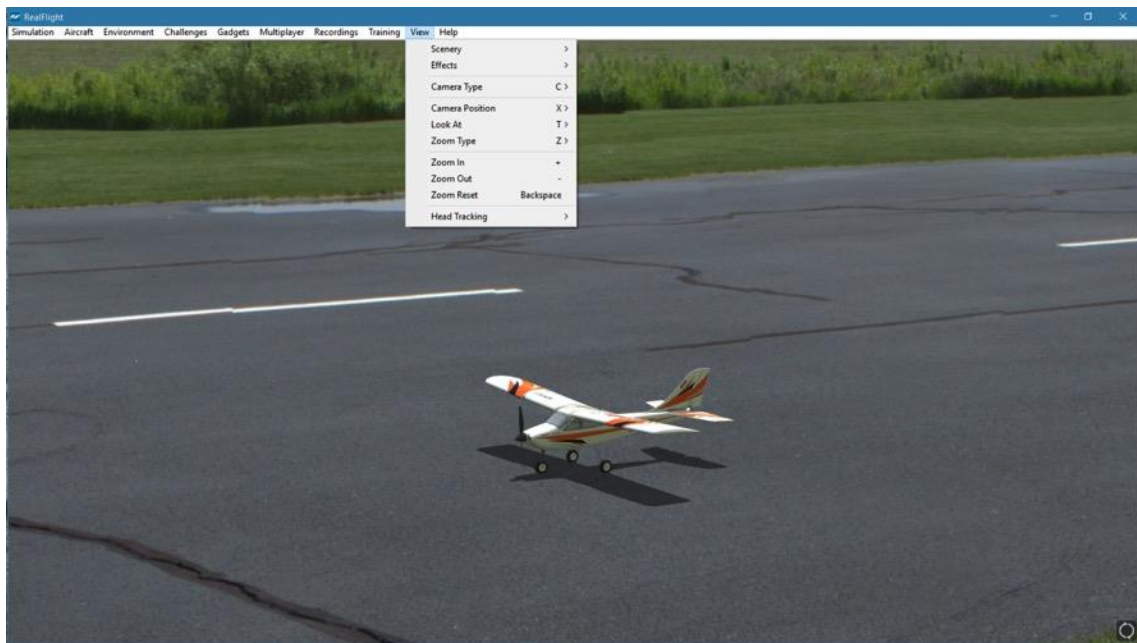

## Scenery

The Scenery menu item is used to determine whether to show or hide scenery objects in the airport.

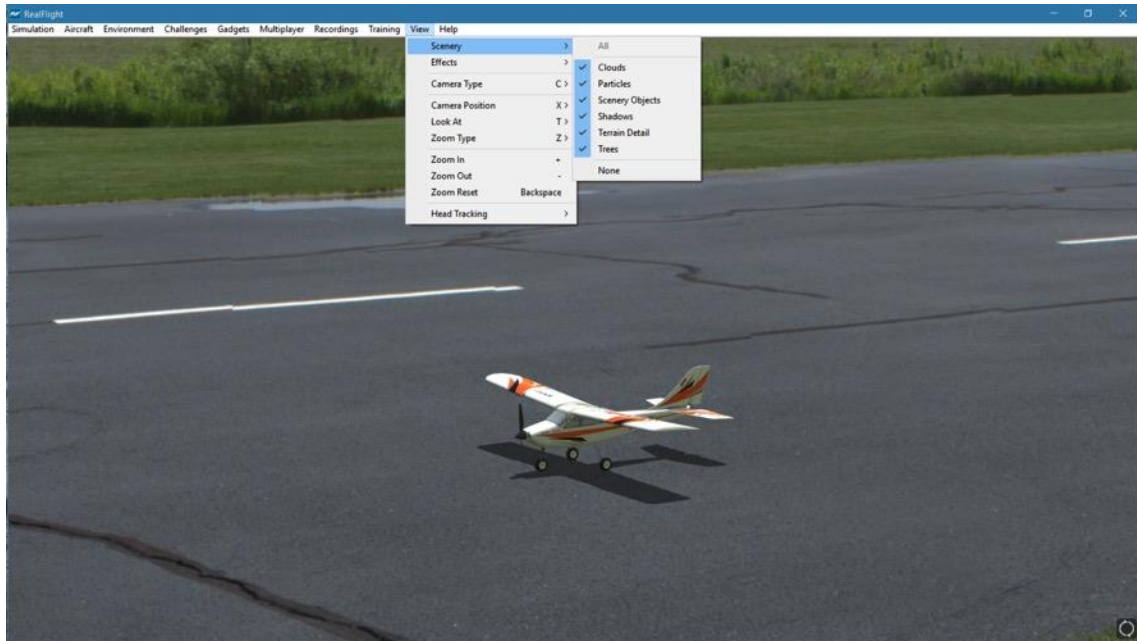

Selecting this item brings forth a pull-down menu with a list of items you can show (make visible within the simulation) or hide (remove from visibility). To show items, check them in the drop-down menu. To hide items, click on them to remove their respective checkmark.

If the frame rate slows dramatically, try eliminating some of the items listed in the Scenery sub-menu. This will improve the frame rate. To remove all items from the scene, click **None**.

## Effects

The Effects menu item is used to determine whether to show or hide simulator enhancement objects in the airport.

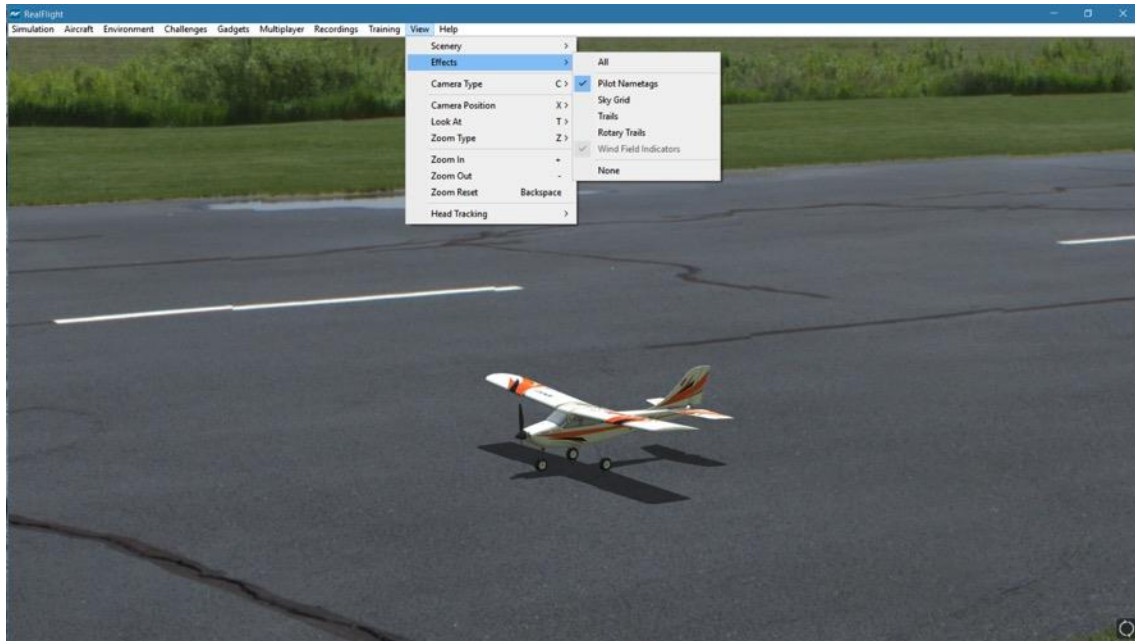

Selecting this item brings forth a pull-down menu with a list of items you can show (make visible within the simulation) or hide (remove from visibility). To show items, check them in the drop-down menu. To hide items, click on them to remove their respective checkmark.

### Pilot Nametags-

When multiple aircraft are flying, either from a multiplayer session, or when you are playing a recording, the pilot's name will follow the aircraft on screen. This indicator will appear on the edge of the screen if the aircraft is out of view, giving you a general direction on where to find that aircraft.

Unchecking this menu item will eliminate the Pilot Nametags from the screen.

### Sky Grid-

As the name suggest, Sky Grid is a framework of lines that appear in the sky when activated. Modelers practicing precision aerobatic maneuvers will appreciate these lines as they will assist them in perfecting their routines.

To enable Sky Grid, click the **View** menu title, followed by the **Effects** sub-menu. Then, click the **Sky Grid** menu item.

## Trails-

Trails, as the name implies, will create a trail or pathway through the sky depicting all facets of flight for the aircraft. This feature is very useful for F3A pattern pilots and F3 heli pilots as well as those modelers wanting to see how precise their maneuvers truly are.

Think you're a precision pilot? You might be able to fool the judges at a contest, but you can't change reality in RealFlight. With RealFlight's Trails feature, the pathway initiates from the wingtips of an airplane model and from the main rotorblades of a helicopter and remains in the sky for the duration of the flight, allowing modelers to thoroughly review their trail from start to finish. If you stray even a fraction from straight-and-level, or your loops aren't exactly round, the evidence is onscreen.

You will also find this feature very useful when used in combination with the Sky Grid feature mentioned above.

To enable Trails, click the **View** menu title, then the **Effects** sub-menu. Then, click the Trails menu item.

## Rotary Trails-

Rotary Trails function similarly to the Trails feature, except it highlights the path of the prop of the airplane or main rotor of the heli; additionally, the rotary trails do not remain onscreen throughout the flight.

To enable Rotary Trails, click the **View** menu title, followed by the **Effects** sub-menu. Then, click the **Rotary Trails** menu item.

## Wind Field Indicators-

Flying at sites designed for practicing thermal and slope soaring flight, Wind Field Indicators will display where the updrafts are located and their direction. To practice real-world scenarios, you may wish to turn off these indicators.

To enable Wind Field Indicators, click the **View** menu title, followed by the **Effects** sub-menu. Then, click the **Wind Field Indicators** menu item.



## Camera Type

The **Camera Type** menu item determines the Camera Type for the active viewport. Each viewport is independently adjustable. Select from a **Fixed Position**, **Nose** or a **Chase** view. If your aircraft is equipped with on-board cameras, they will be listed here as well.

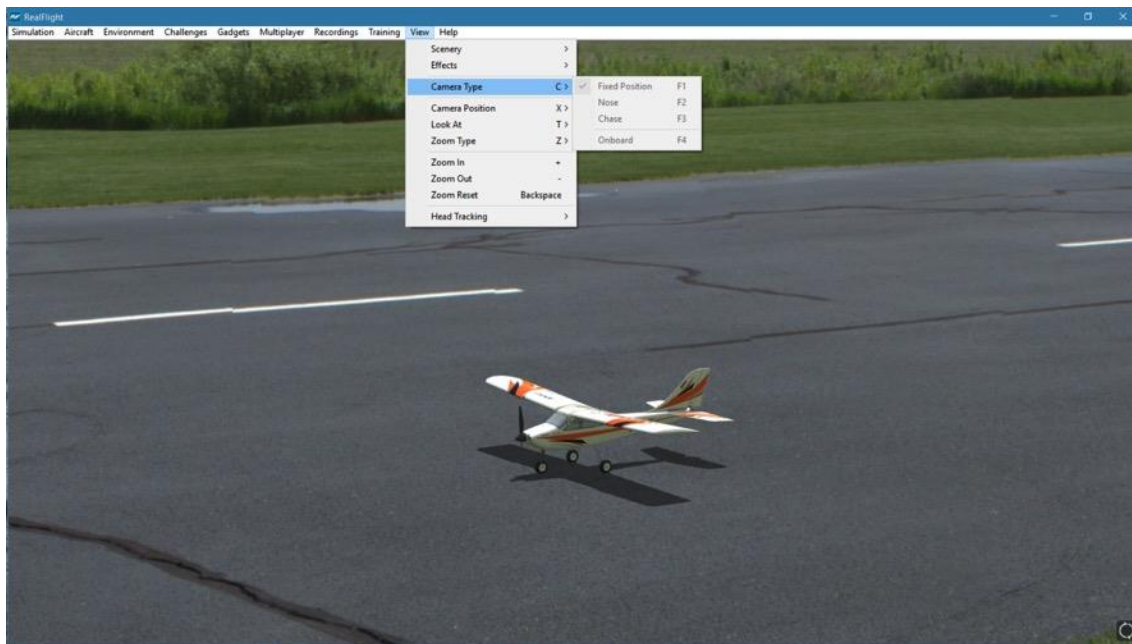

To access the Camera Type adjustments, click on the **View** menu followed by the **Camera Type** menu item. Select your preferred view from the pull-down list.

Please note: Some airports do not allow Camera Type adjustments.



### Fixed Position-

In this mode, the camera remains in a fixed, stationary position. The position is determined by the Camera Position setting.



### Nose-

The Nose selection places the camera at the front of the aircraft looking forward.

To magnify the view or zoom in on the selected item, press the **[+] (plus)** key on the keyboard. Each time you press the **[+] (plus)** key or select the **Zoom In** menu item, the zoom level increases incrementally. Alternatively, you may select the **Zoom In** option from the **View** menu.



To decrease the magnification, or zoom away from the selected item, press the **[-] (minus)** key on the keyboard. Each time you press the **[-] (minus)** key or select the **Zoom Out** menu item, the zoom level decreases incrementally. Alternatively, you may select the **Zoom Out** option from the **View** menu.



### Chase-

The Chase mode positions the camera behind the aircraft. The camera will follow the aircraft as it moves.

To magnify the view or zoom in on the selected item, press the **[+] (plus)** key on the keyboard. Each time you press the **[+] (plus)** key or select the **Zoom In** menu item, the zoom level increases incrementally. Alternatively, you may select the **Zoom In** option from the **View** menu.

To decrease the magnification, or zoom away from the selected item, press the **[-] (minus)** key on the keyboard. Each time you press the **[-] (minus)** key or select the **Zoom Out** menu item, the zoom level decreases incrementally. Alternatively, you may select the **Zoom Out** option from the **View** menu.



### Onboard Cameras-

Depending on the aircraft, there may be additional cameras available on and around the aircraft, looking at a variety of different directions and perspectives. For example, the P-51 Mustang is equipped with three onboard cameras that include:

- **Cockpit** – This camera is placed inside the P-51 cockpit, looking forward, much like sitting in a real aircraft. This camera also includes some “intelligence”, moving and rotating based on the current aircraft motion or movement.

For example, during normal flight, the cockpit camera will try to predict and look in the direction the aircraft is likely to fly. If you were to fly a knife edge maneuver, the camera will look down towards the ground.

During combat events, this camera will attempt to look at the player you have targeted.

- **Rear** – This camera angle is positioned slightly above the nose of the airplane, looking rearward towards the cockpit and tail.
- **Tail** – Positioned at the top of the vertical stabilizer, this camera looks forward towards the nose of the airplane.

- Wing – Positioned at the tip of the port-side wing, looking back at the cockpit.

Onboard cameras can be added and modified much like other parts of the aircraft. Refer to page 128 in Edit Current Aircraft section for more information on how to edit RealFlight aircraft.



## Camera Position

This menu item determines where the camera will be situated when viewed from the ground. Depending upon the airport selected, there may be one or more Pilot Spawn locations to use as camera positions.

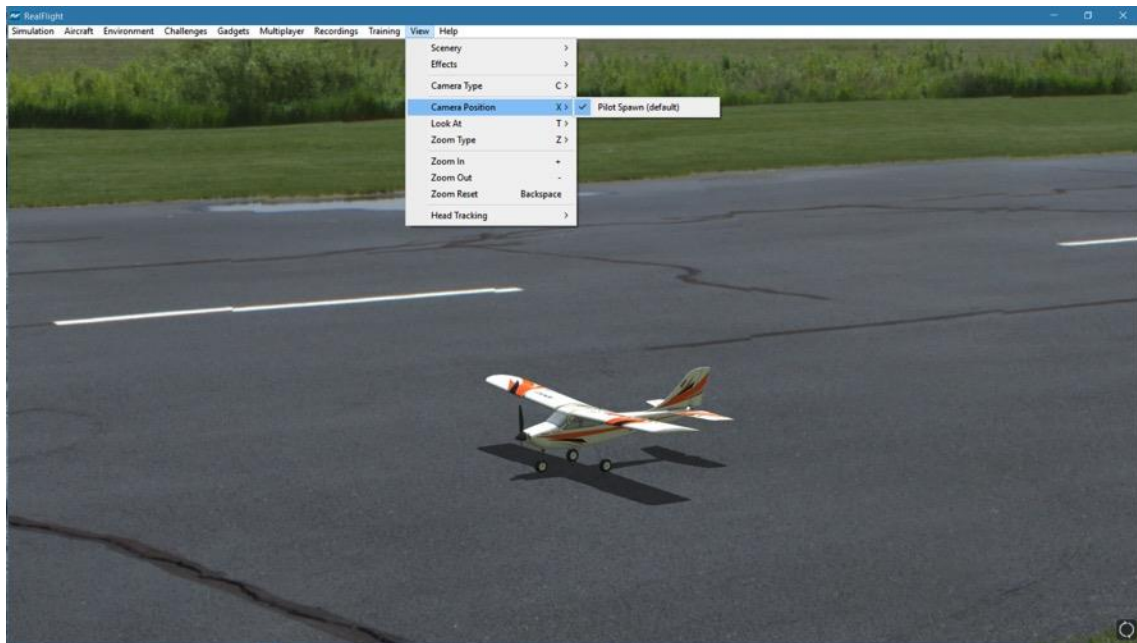

The RealFlight 9 simulator automatically picks the default Pilot Spawn for the airport that you have loaded.

To change the setting, click on the viewport to you wish to modify. This becomes the active view in the simulation. To access the Camera Position adjustments, click on the **View** menu followed by the **Camera Position** menu item. Select your preferred view from the drop-down list.

You may also press the keyboard's '**X**' key to toggle through the available Camera Position options. If the airport has two pilot spawn locations, for example, pressing the '**X**' key will toggle back and forth between these two locations.



## Look At

This menu item changes what the camera looks at. Usually you will want the camera to remain focused on your aircraft.

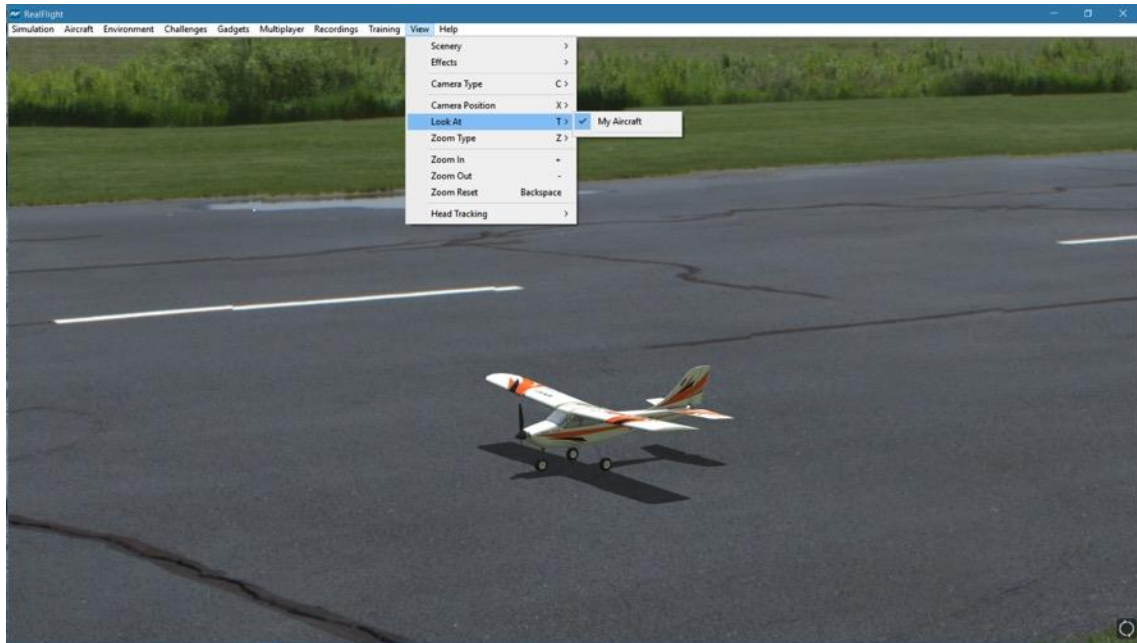

Click on the viewport that you wish to modify. This becomes the active view in the simulation. To access the list of things to look at, click on the **View** menu followed by the **Look At** menu item. Then select an item to look at. For example, if you are in a multiplayer or MultiMode session, the other players in the session will be listed in the popup menu. Select a player to look at his/her aircraft.



## Zoom Type

The Zoom Type menu item allows you to change the type of zoom used in the simulation.

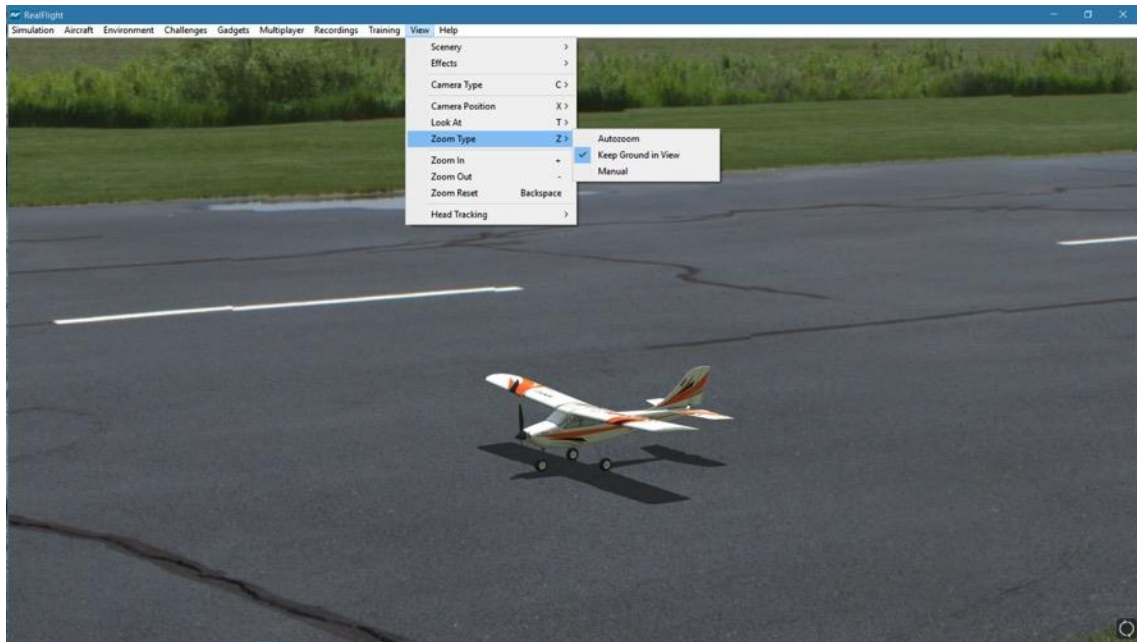

Click on the viewport that you wish to modify. This becomes the active view in the simulation. To access the Zoom Type menu item, click on the **View** menu followed by the **Zoom Type** menu item. Select the **Zoom Type** option that accomplishes your goal. You may choose between **Manual**, **Autozoom**, and **Keep Ground in View**.

### Autozoom-

This zoom type adjusts the zoom range based on the distance of the aircraft from the pilot. The camera automatically zooms in as the aircraft gets further from the pilot and then automatically zooms out as the aircraft gets closer to the pilot.

### Keep Ground in View-

This zoom type attempts adjust the camera so that the aircraft and the ground are always in view. This is the only zoom type that disallows zooming in and out.

### Manual-

This enables the standard view with zoom capabilities. See the *Zoom In* and *Zoom Out* sections below for more information.



## Zoom In

Once you have selected the type of zoom that you desire, RealFlight allows you to customize it further by zooming in.

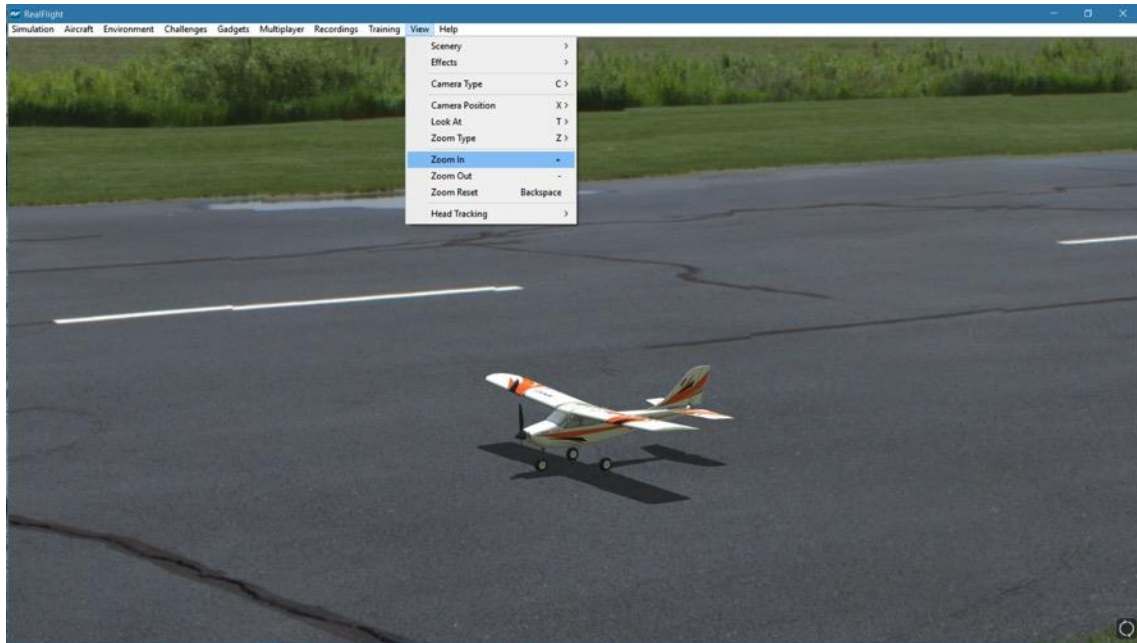

Click on the viewport that you wish to modify. This becomes the active view in the simulation. To access the Zoom In menu item, click on the **View** menu followed by the **Zoom In** menu item.



## Zoom Out

Once you have selected the type of zoom that you want you can customize it further by zooming out. Zooming Out decreases the magnification.

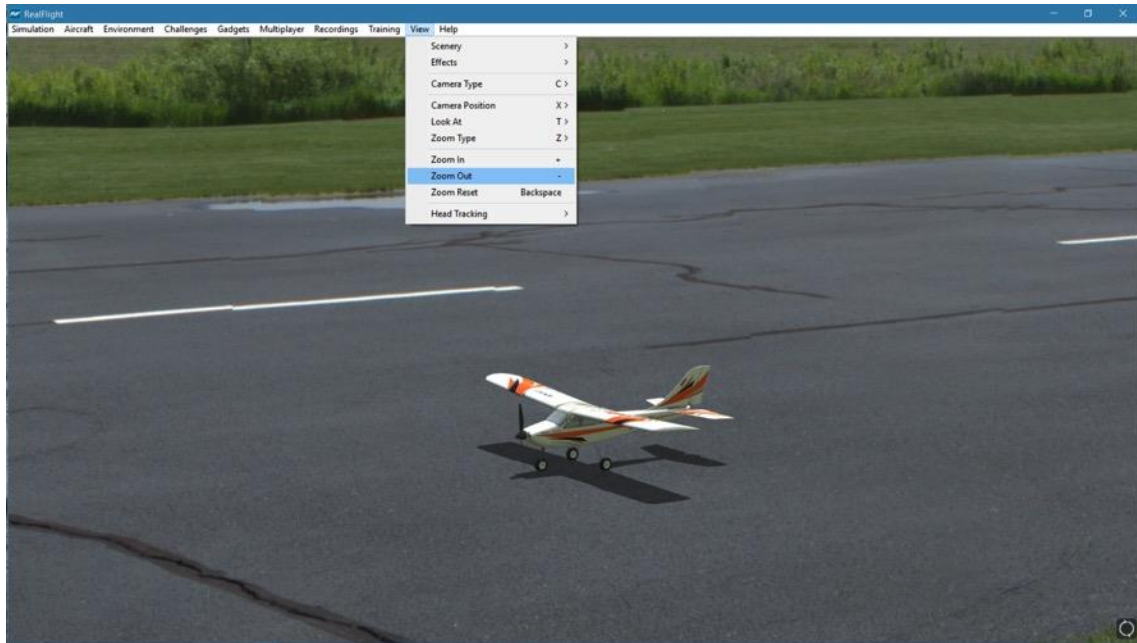

Click on the viewport that you wish to modify. This becomes the active view in the simulation. To access the Zoom Out menu item, click on the **View** menu followed by the **Zoom Out** menu item.



## Zoom Reset

This selection resets the zoom magnification level to its default value. This is useful if you are zoomed way in or way out and want to return quickly to the default level of magnification.

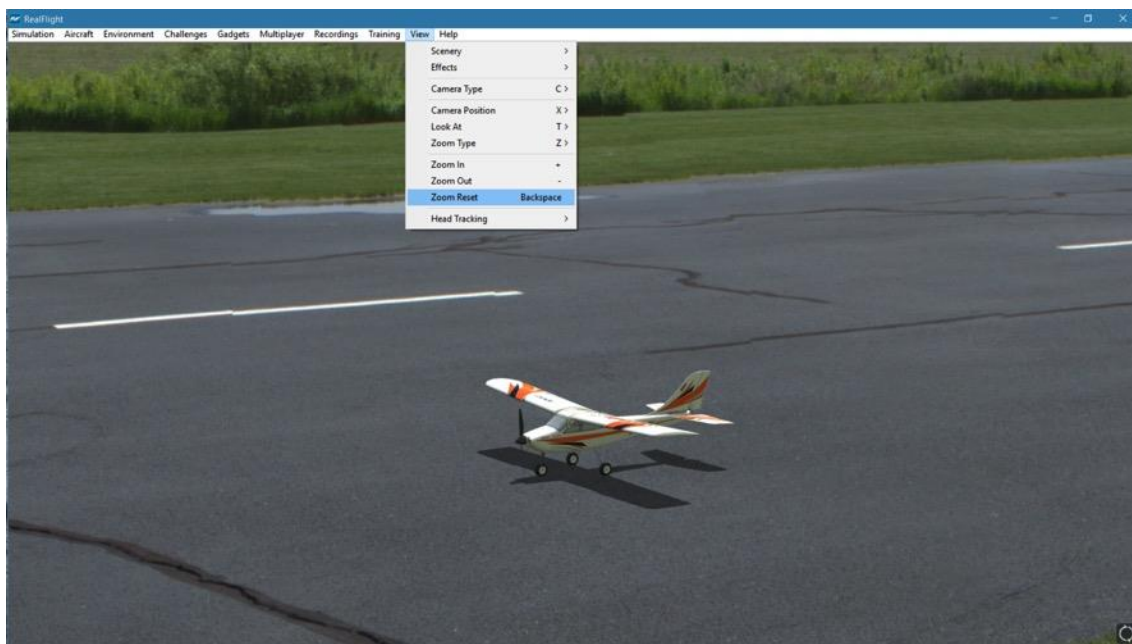

Click on the viewport that you wish to modify. This becomes the active view in the simulation. To access the Zoom Reset menu item, click on the **View** menu followed by the **Zoom Reset** menu item.

## Head Tracking

RealFlight 9 is compatible with the TrackIR from NaturalPoint. With a TrackIR plugged into your computer, you can control the camera with the movement of your head as if you are at the field looking around.

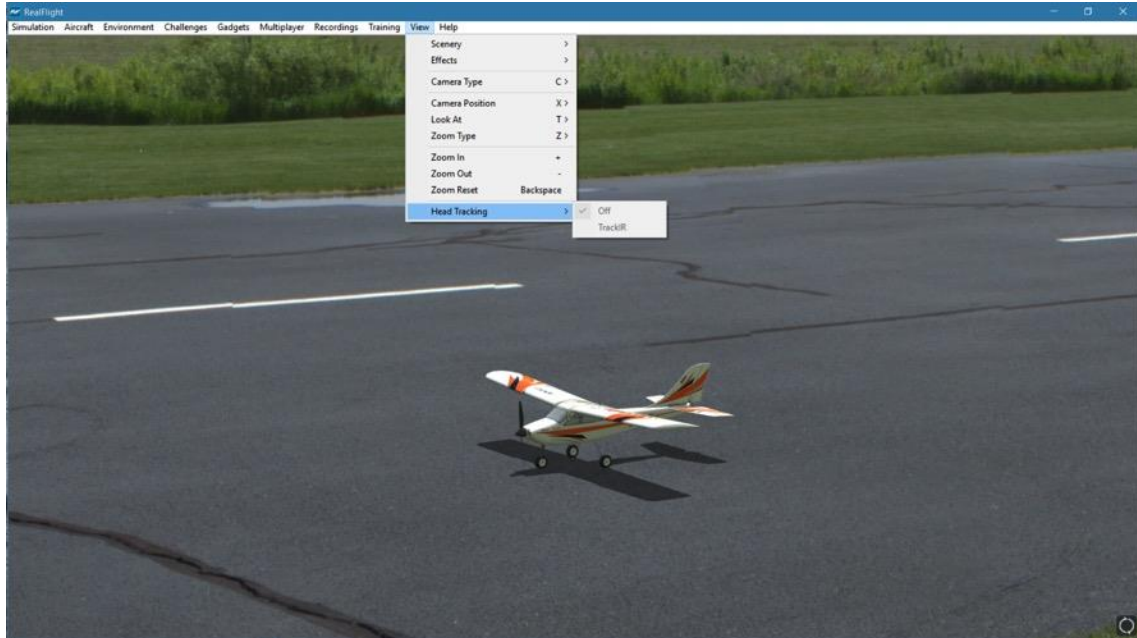

For example, if you are flying at a high altitude and wish to line up with the runway, at a flying field you would look down briefly. With the TrackIR, you would do the same at your computer. With a small movement of your head, you can look down at the runway and back up to your aircraft.

For more information about TrackIR, and where to purchase one, visit NaturalPoint's website at:

<http://www.naturalpoint.com/trackir/>



# Help Menu

*WHEN ALL ELSE FAILS, ASK FOR HELP.*

This menu provides you with miscellaneous assistance and guidance with a variety of simulator-related issues.

To access the Help files, click on the Help menu title.

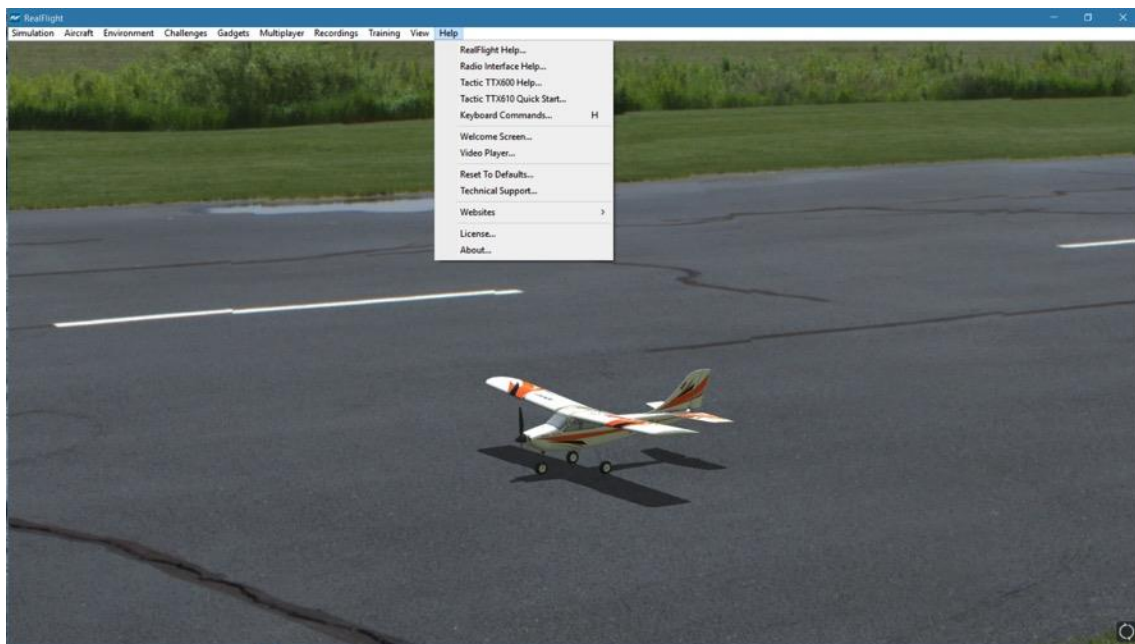

## RealFlight Help

This menu item accesses the RealFlight 9 manual which you are reading now.

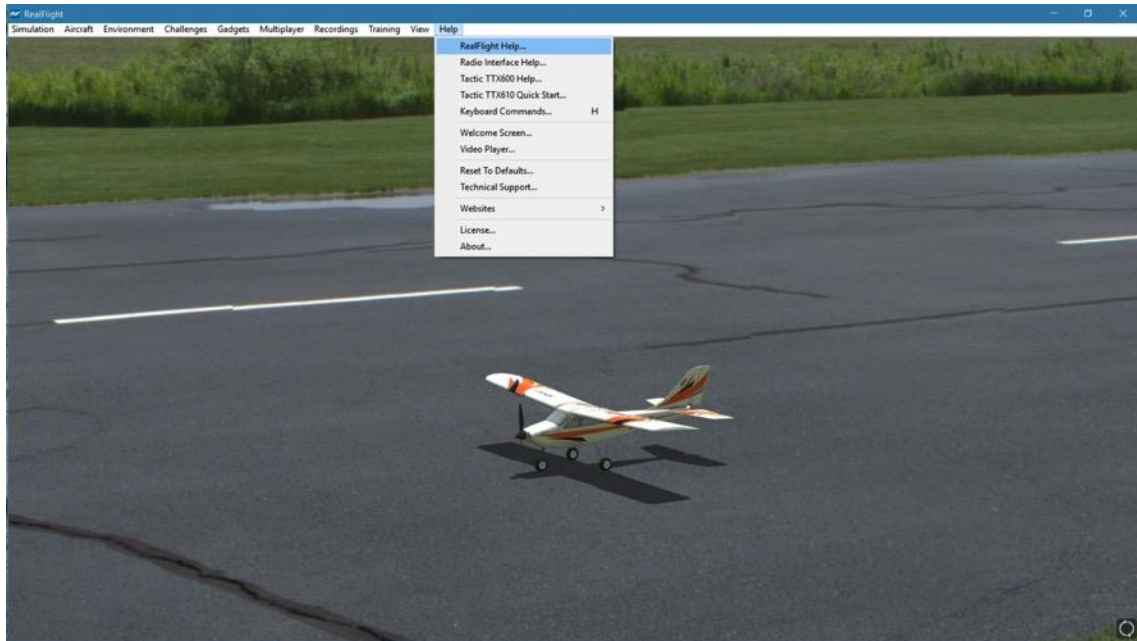

To access the **RealFlight Help** file, click on the **Help** menu title.

## Radio Interface Help

We understand that setting up RealFlight to function correctly with your real transmitter can be daunting the first time. To assist you with this particular task, we've provided a guide to walk you through this setup.

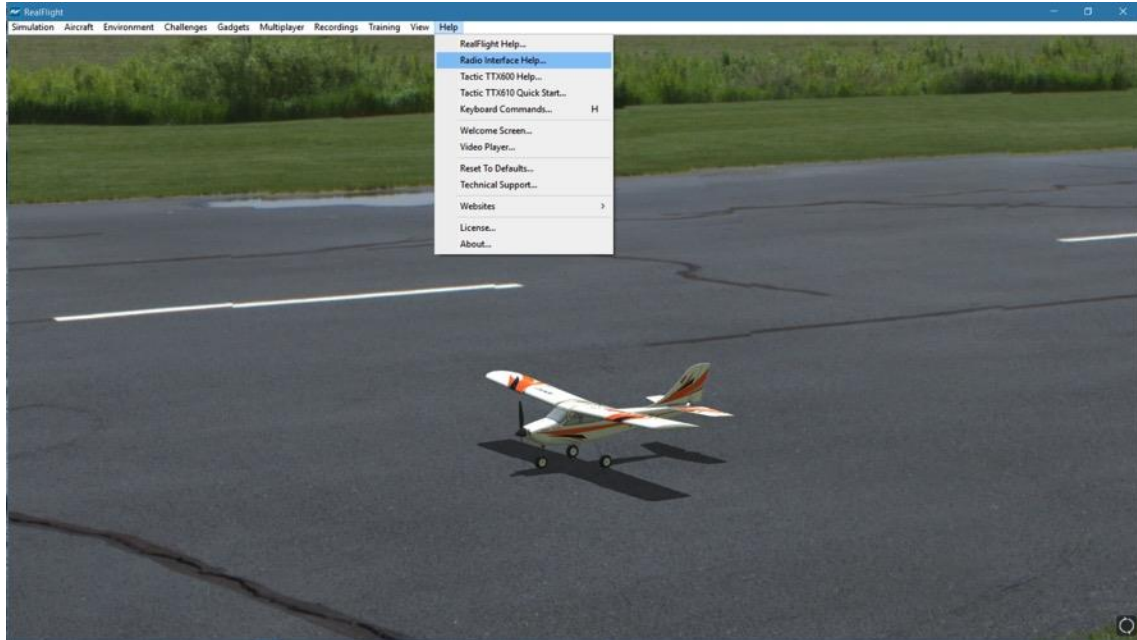

To access this guide, click the **Radio Interface Help** menu item.

## Tactic TTX600 Help

Past versions of RealFlight included the Tactic TTX600 SLT radio. Along with the Radio Interface Help document, the Tactic TTX600 Help file continues with detailed setup instructions specifically for this radio.

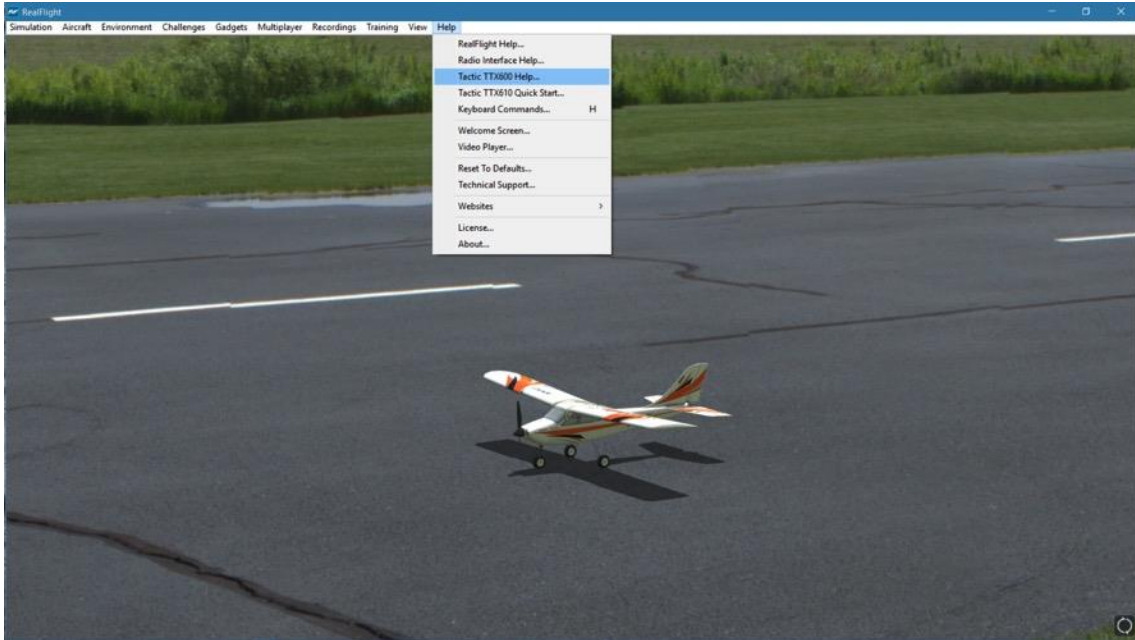

Access this document by clicking the **Tactic TTX600 Help** menu item.

## Tactic TTX610 Quick Start

Previous versions of RealFlight also included the Tactic TTX610 SLT radio. Along with the Radio Interface Help document, the Tactic TTX610 Quick Start file provides additional instructions on how to set up the TTX610.

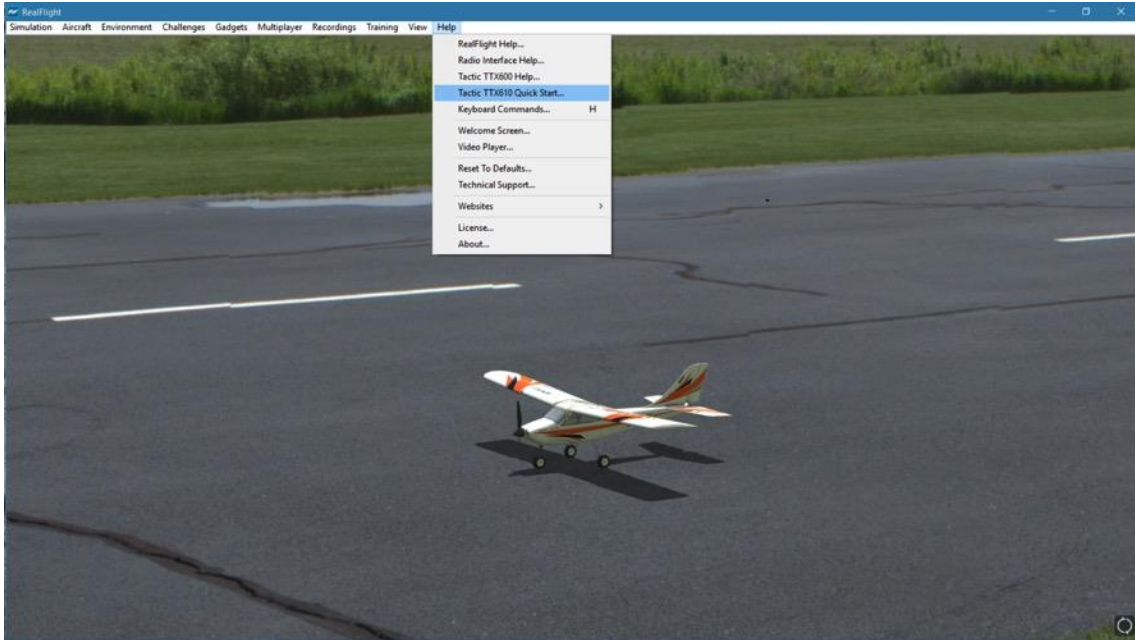

Access this document by clicking the **Tactic TTX610 Quick Start** menu item.



## Keyboard Commands

RealFlight allows you to access menu and other commands from your computer's keyboard. A key that directly invokes a command is called a "quick key" or "hot key".

For example, pressing the **[+] (plus)** key on the keyboard's number pad incrementally zooms your view towards the aircraft. This is exactly the same result that arises if you select Zoom In from the RealFlight 9's View menu item. Consequently, we say that the **[+] (plus)** is a hot key for the Zoom In command.

To access the Keyboard Commands, click the **Help** menu title, followed by the **Keyboard Commands** menu item.

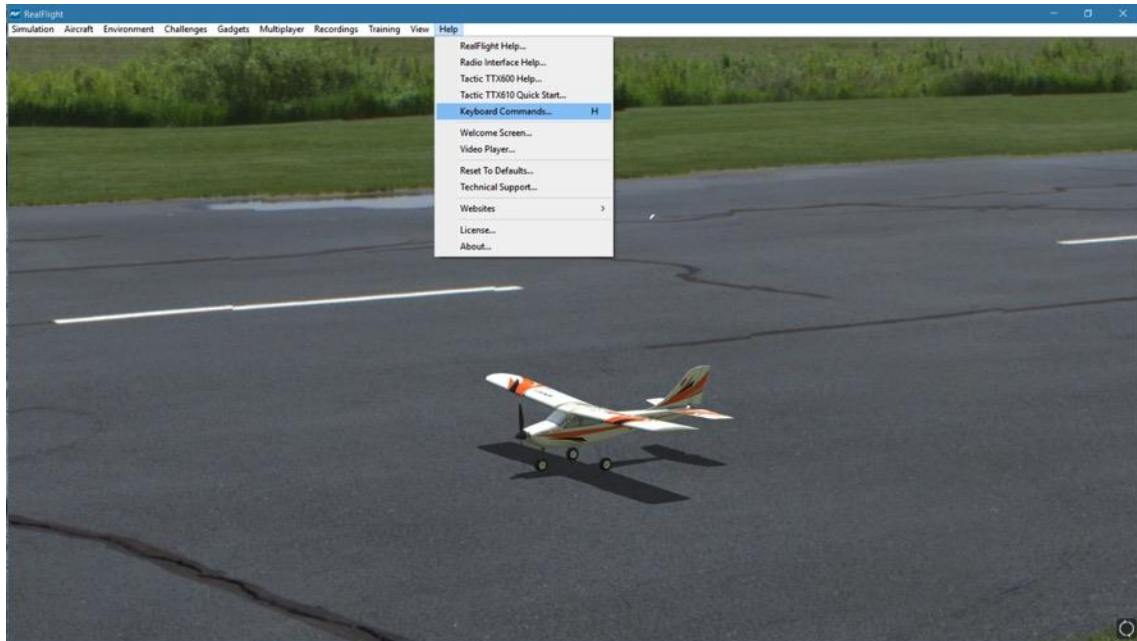

The following overlay will appear:



The Keyboard Commands screen contains all of the information pertaining to the hot keys. To view the entire list, drag the scroll bar on the right side of the Keyboard Commands screen down. Alternatively, this list is also contained on the back cover of the Installation Guide which accompanied this software [DVD version only].

Clicking on the 'X' in the title tab of the frame will remove it from the screen.

## Welcome Screen

The Welcome Screen that appears when you first start RealFlight can be accessed at any time from this menu item.

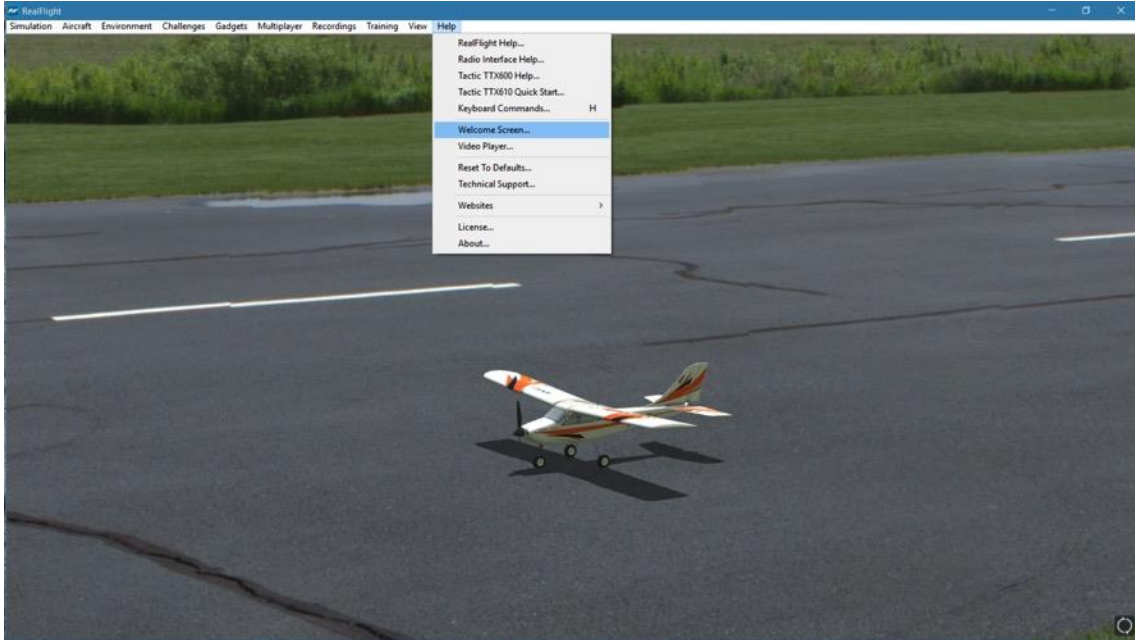

The Welcome Screen gives you the ability to change aircraft, flying sites or scenarios. You may also select a most recently flown aircraft, earn Challenge medals, or open the video player window.



## Video Player

RealFlight offers training videos to assist the first-time RC pilot as well as videos to highlight some of the more popular features available. Selecting the Video Player menu item will display the following screen.

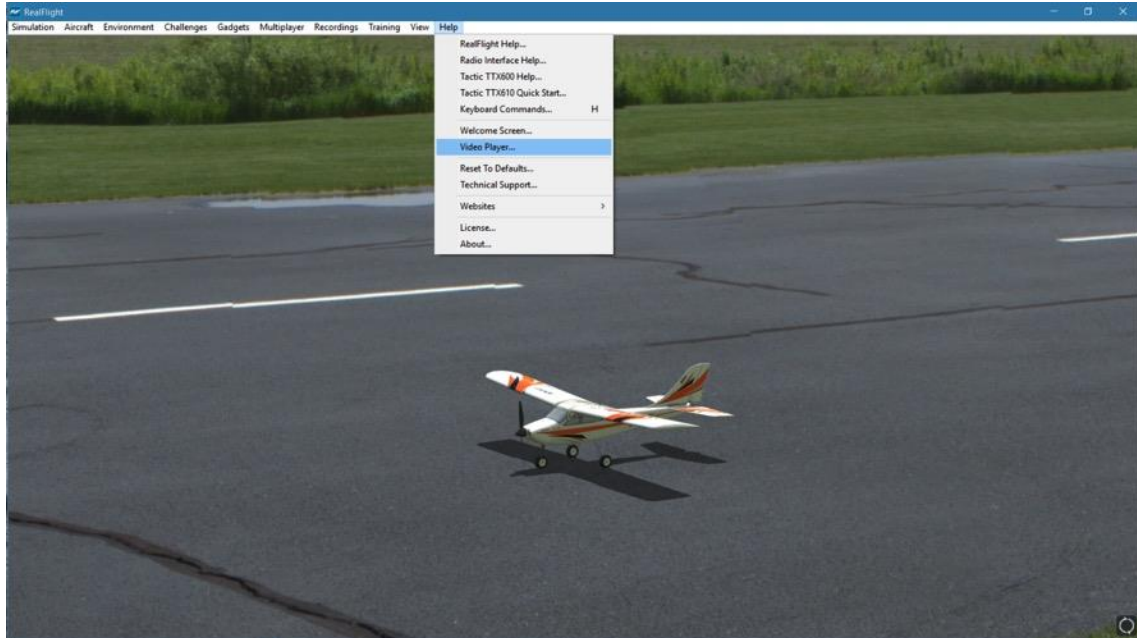

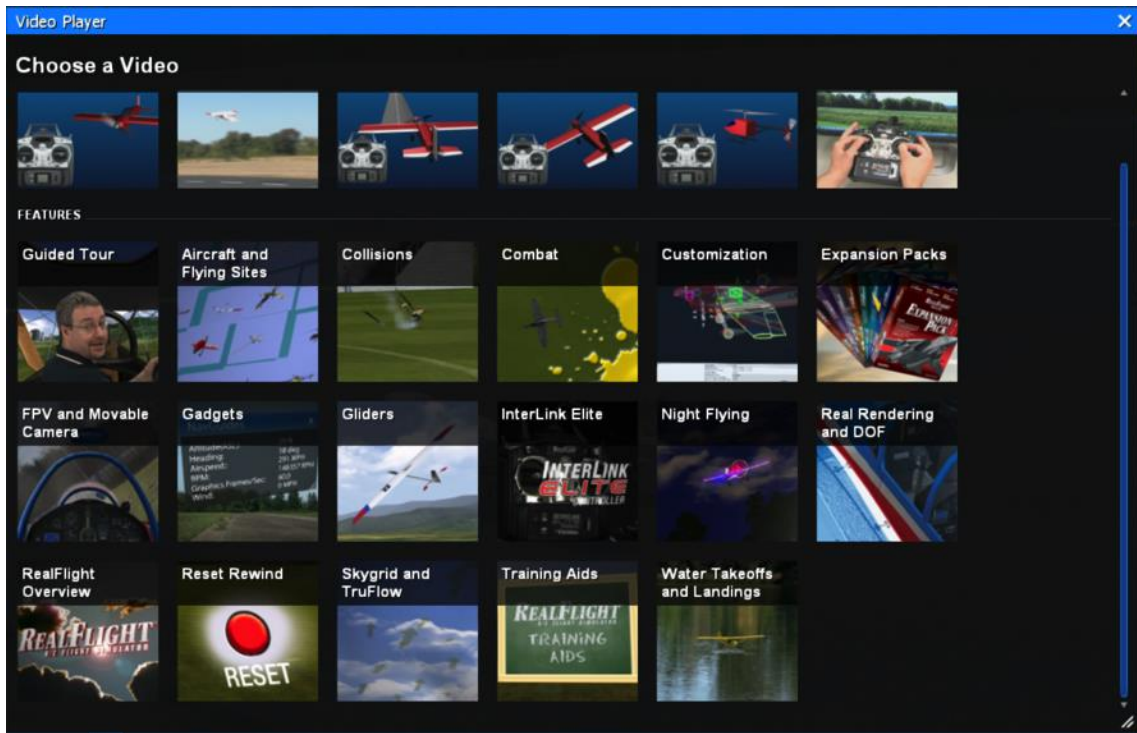

Clicking a thumbnail will automatically start that video. To return to the video selection screen, simply click the **Choose Another Video** button found at the lower right corner.

The Video Player is also accessible from the Welcome Screen.

## Reset to Defaults

This option will reset all of your RealFlight settings to their original values and then restart the simulator.

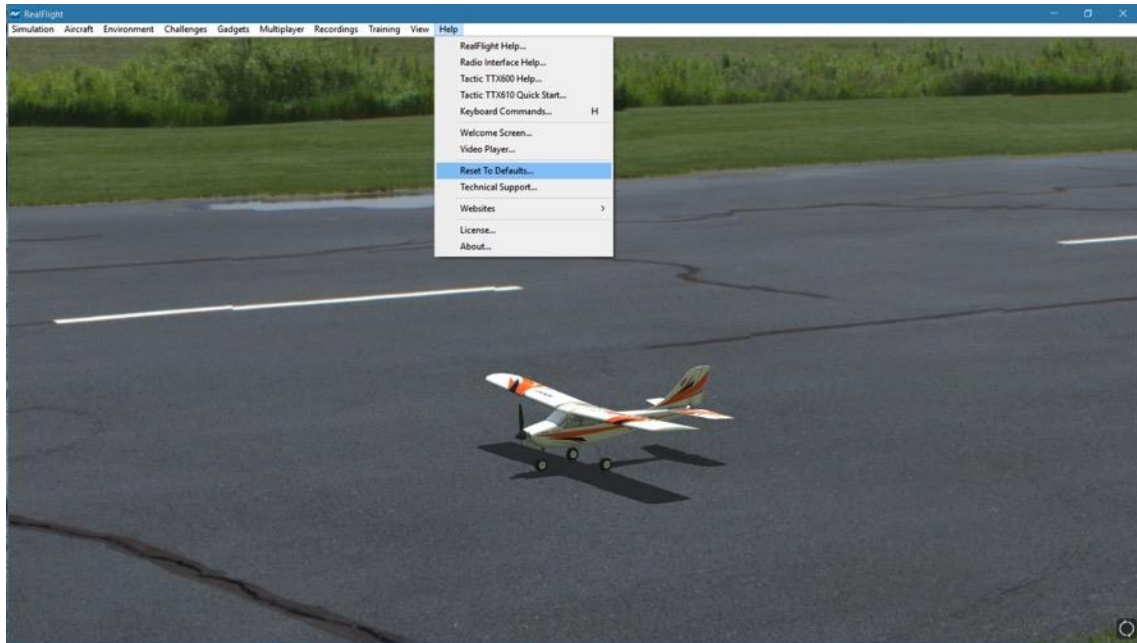

It is perfectly safe. Custom content such as modified aircraft and airports, imported content from the swap pages, and challenge scores will not be affected. Think of this as a way to freshen your installation and make it like new without having to uninstall and reinstall. It is a good way to fix things if you've made a change you don't like but can't remember what you did.

## Technical Support

Choose this to exit the simulator and open a separate Technical Support dialog. It will take a minute to gather data before it appears; this is normal.

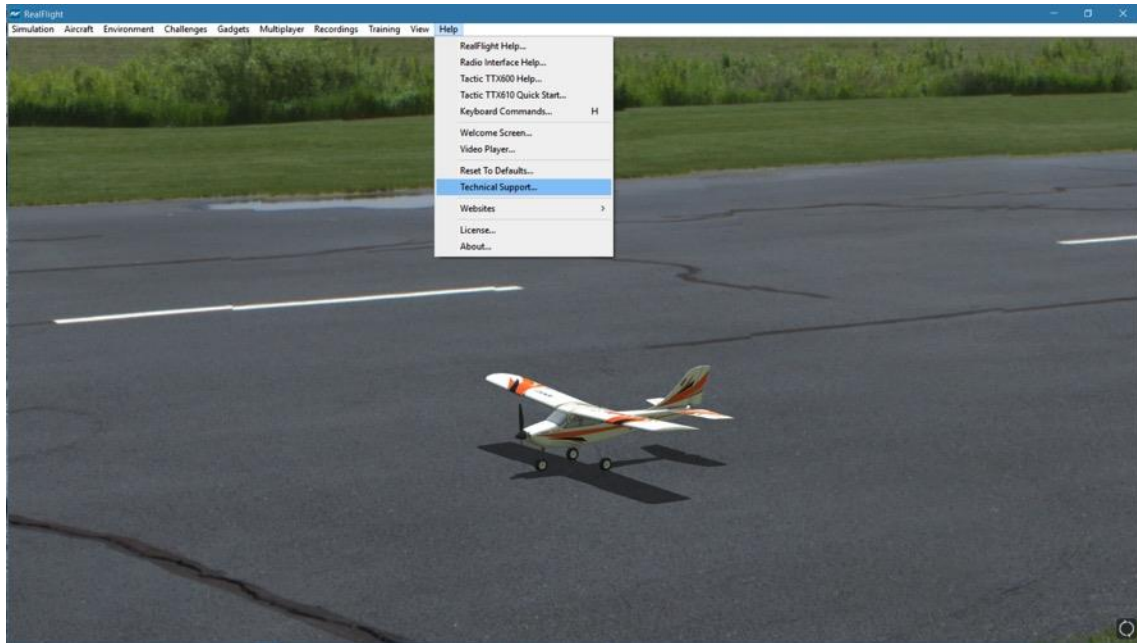

For more information please see the Technical Support section in Appendix B.

## Websites

This menu item contains direct links to the RealFlight related websites. Please ensure that you are connected to the internet before making your selection. The options include:

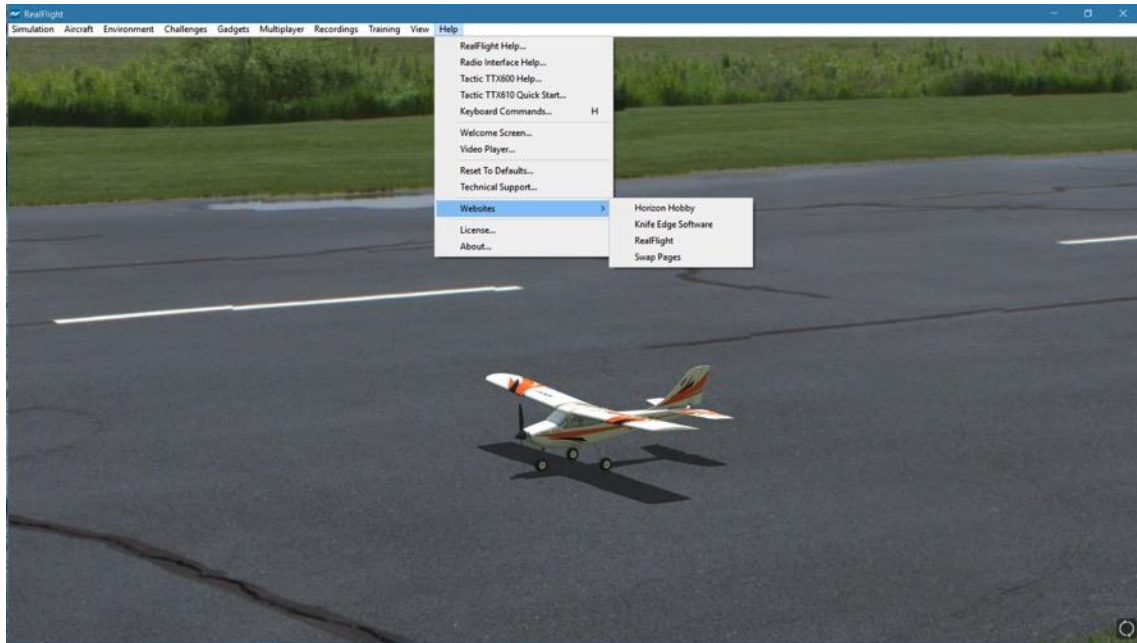

### Horizon Hobby, LLC-

Publishers of the RealFlight 9 RC Simulator. Visit their site for information pertaining to the many other Horizon Hobby exclusive product offerings.

### Knife Edge Software-

Developers of the RealFlight 9 RC Simulator. Visit the Knife Edge forums to share experiences and technical support with other RealFlight owners. The Knife Edge forums also play host to a wide variety of free, downloadable aircraft, trim schemes, flying sites and more.

### RealFlight-

Visit the RealFlight website for more information about the RealFlight family of products, search the knowledge base for technical support, or for information on how to contact our support staff if you have questions.

### Swap Pages-

If you have created your own aircraft, flying site or recording and would like to share it with the rest of the RealFlight community, you can do so at the RealFlight Swap Pages. Or, visit the swap pages to download hundreds of aircraft, flying sites, etc. to add to your RealFlight hangar.

## License

This menu item contains the End Users License Agreement (EULA) for the RealFlight RC Flight Simulator. Please read it carefully.

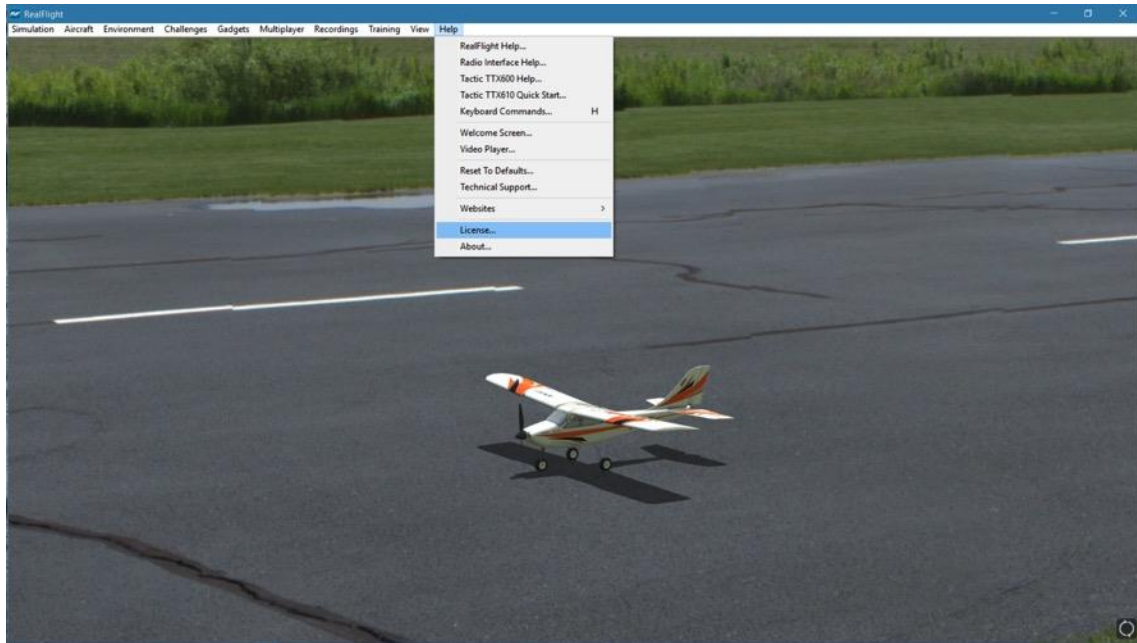

Clicking on the 'X' in the title tab of the frame will remove it from the screen.

## About

The **About...** menu item contains miscellaneous information pertaining to your software including your RealFlight serial number and the version number of the software that you are currently operating.

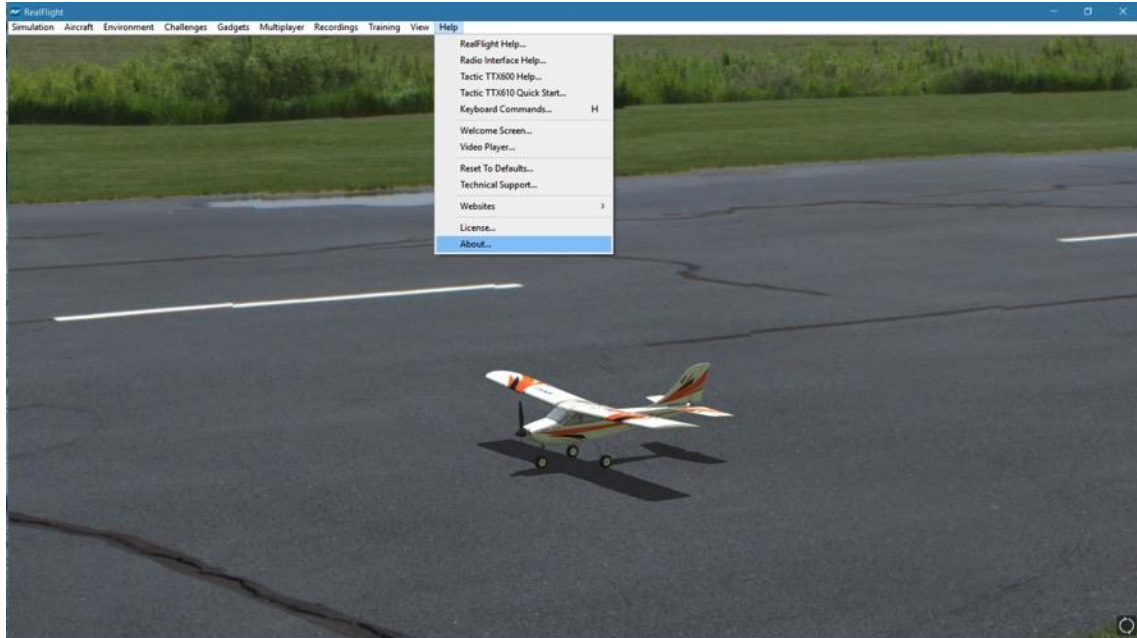

Also seen in the About screen are the credits and names of the people that have worked together to bring you one of the world's most realistic RC simulators, RealFlight 9.

Clicking on the 'X' in the title tab of the frame will remove the About window.

# Virtual Reality

*PUT ON A VR HEADSET TO COMPLETELY IMMERSE YOURSELF INTO REALFLIGHT.*

**R**ealFlight 9 is compatible with the Oculus Rift and the HTC Vive, two of the most popular VR devices currently available. Using VR with RealFlight increases the realism and completely submerges, and immerses, you into the environment.



You will need to purchase VR hardware to take advantage of this feature. RealFlight 9 is compatible with the Oculus Rift S and the HTC Vive.

For more information about these devices, check out their websites at:

Oculus Rift: <https://www.oculus.com/rift-s/>

HTC Vive: <https://www.vive.com>

In order to use the Oculus Rift S with RealFlight, please make sure to allow **Unknown Sources**. This option is found in the Settings in the Oculus software.



Once set up, simply put on the VR headset. RealFlight will detect the VR device and automatically switch to VR mode. Taking off the headset will revert back to normal mode.

VR enables you to fly from standing on the ground looking up at your aircraft, exactly like you would at your local flying field. At any flying site on RealFlight, set the throttle to zero and reset the aircraft. Now, put on the VR headset. By default, you should be looking at your aircraft. Fly as normal, but move your head to keep the aircraft in your view. While flying, you can look around, find the runway and keep an eye out for the pits, and then quickly look back at the aircraft, exactly like you would in real life at your local RC field.

To add a jolt of excitement, change your camera view to sit in the cockpit of the aircraft, allowing you to look around while flying. You must choose to fly at a 3D airport to take advantage of this feature. PhotoField airports will not work. Put the VR headset on, then press the **C** key to cycle through the different camera viewpoints. If the aircraft is set up for it, one of the viewpoints will be from the cockpit of the aircraft. From this vantage point, take the time to move your head around to look at everything, including outside the aircraft. You can even move forward/backwards and side-to-side to adjust your position in the cockpit. The options are nearly limitless.

# InterLink DX Controller

*Utilizing the InterLink DX controller to improve your flying experiences.*

Prior to picking up the InterLink DX controller and simply thrashing around the sky, it's beneficial to completely understand all that the InterLink DX controller has to offer as a controller and an interface as well.



## InterLink DX Layout-

The InterLink DX unit offers two two-position switches, five three-position switches, a rotary knob, and a push-button, two horizontal sliders and two gimbal sticks to control the aircraft within the simulation. Our engineering staff have designed this controller, and the applicable functionality to mimic the typical input offerings from actual Spektrum transmitter offerings.

Additionally, the staff have incorporated the Scroll Wheel/Select button as well as the Reset and Cancel buttons to enhance the RealFlight experience.

Below you will find the identification/layout of the switches, gimbals, etc. In subsequent areas of this Appendix, we will further explore the options, etc. that are offered by the newly developed Spektrum InterLink DX controller- and from the RealFlight 9 RC Flight Simulator accordingly.

As you'll see, this is much more than a simple joystick controller or gaming device, used properly the Spektrum InterLink DX controller and the RealFlight 9 RC Flight simulator software will prepare you for many, many years of flying and complete enjoyment of the hobby alike.

1	Switch A (2 Position)
2	Switch B (3 Position)
3	I Button
4	Switch C (3 Position)
5	Switch D (3 Position)
6	R Knob
7	Switch F (3 Position)
8	Switch H (2 Position)
9	Switch G (3 Position)
10	Left Stick
11	Right Stick
12	USB Cable
13	Reset Button
14	Cancel Button
15	Scroll Wheel / Select Button

16	Power LED
17	Rudder Trim (Mode 1, 2) Aileron Trim (Mode 3, 4)
18	Elevator Trim (Mode 1, 3) Throttle Trim (Mode 2, 4)
19	Elevator Trim (Mode 2, 4) Throttle Trim (Mode 1, 3)
20	Rudder Trim (Mode 3, 4) Aileron Trim (Mode 1, 2)
21	Neck Strap Mount
22	Gimbal Stick Tension Adjust (Up/Down)
23	Gimbal Stick Tension Adjust (Left/Right)
24	Throttle Tension Adjust
25	Throttle Ratchet Adjust
26	Right Rear Slider
27	Left Rear Slider
28	Mode Change Switch
29	Trainer Port
30	Handle

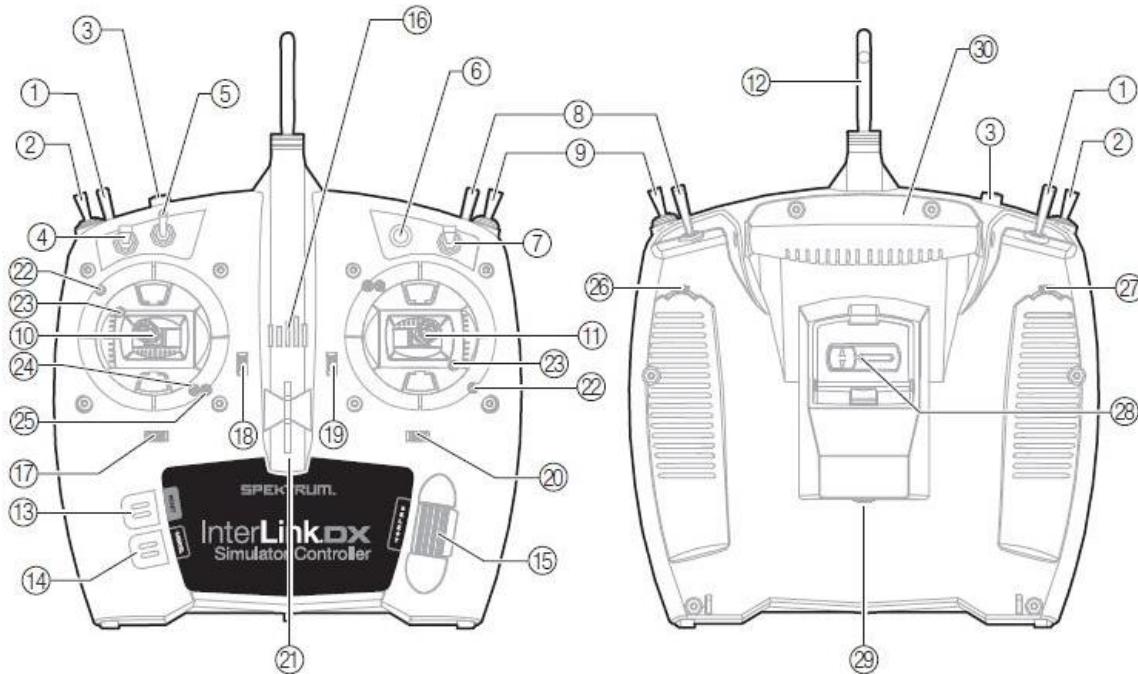

## Physical Transmitter Adjustments-

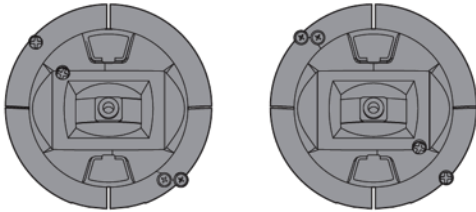

The InterLink DX Controller incorporates all of the physical transmitter adjustments located around the gimbal face of each gimbal. This arrangement allows for quick and easy adjustments without taking the back cover off or removing any plugs to access adjustment screws.

### Available adjustments:

- Change the Throttle Ratchet
- Change the Throttle Tension
- Adjust stick tension

## Ratcheted Throttle- Smooth Throttle Adjustment

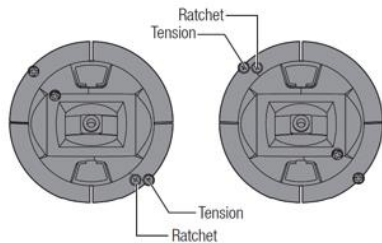

### Ratchet

1. Locate the Throttle Strap adjustment screws on both gimbals. The ratchet set screw engages a serrated section on the gimbal for a ratcheted throttle, while the tension set screw engages a strap for smooth tension on the gimbal.
2. To engage the throttle ratchet, turn the ratchet screw clockwise until the ratchet engages.
3. To disengage the throttle ratchet, turn the screw counter-clockwise until the gimbal moves freely.

### Smooth Tension

1. To engage the throttle tension, turn the Tension screw clockwise until the Tension engages.

2. To disengage the throttle Tension, turn the screw counter-clockwise until the gimbal moves freely.

## Adjust Stick Tension

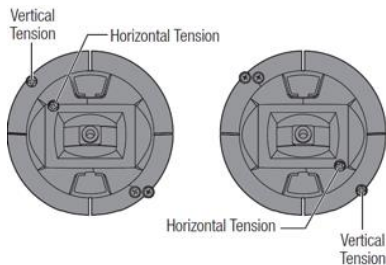

Turn the screws clockwise a small amount using a small Phillips screwdriver to tighten the stick tension and counter-clockwise to loosen.

Note: Always perform a test of the stick tension while turning these screws to ensure that stick tension is not too loose or too tight. Tightening a screw too much may damage a spring. Loosening the screw too much may cause the spring to fall off possibly resulting in a short-circuit in the transmitter.

## Control Stick Length Adjustment



1. Using a 2mm Allen wrench, turn the setscrew in the stick counter-clockwise to loosen.
2. Make the stick shorter by turning it clockwise. To make the stick longer, turn the stick in a counter-clockwise direction.
3. After the adjustment of the stick lengths are completed, tighten the setscrew accordingly.

## Mode Change Slider

There is a unique slider located on the back of the InterLink DX controller that allows for simple mode changes. This slider can also be used to change each mode into a 'quadcopter mode.' This mode snaps both sticks to the center position accordingly.

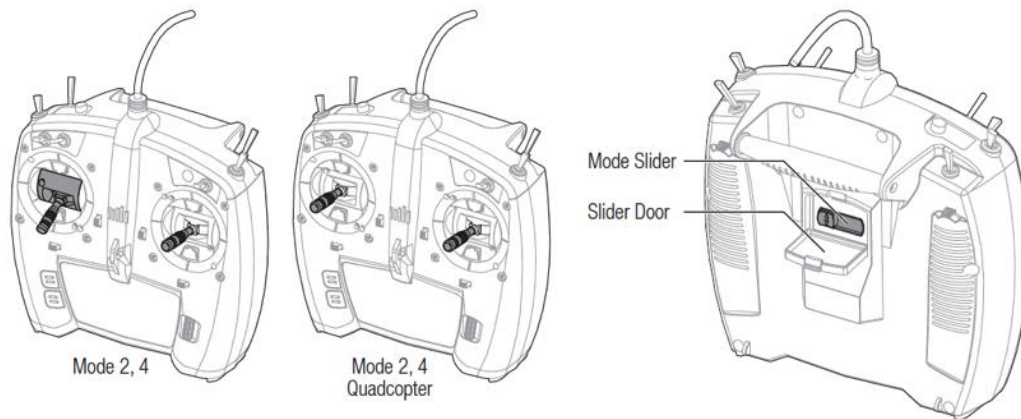

## Safety Plug

The Safety plug is installed in the controller to ensure that the mode switch cannot be accidentally moved when in the normal throttle mode (non-centered) positions.

To remove the plug:

1. Grasp the plug by the raised rib and pull straight out.  
**Tip:** Use a small flat-bladed screwdriver to gently pry the plug out.
2. Once the mode has been changed, reinstall the safety plug.

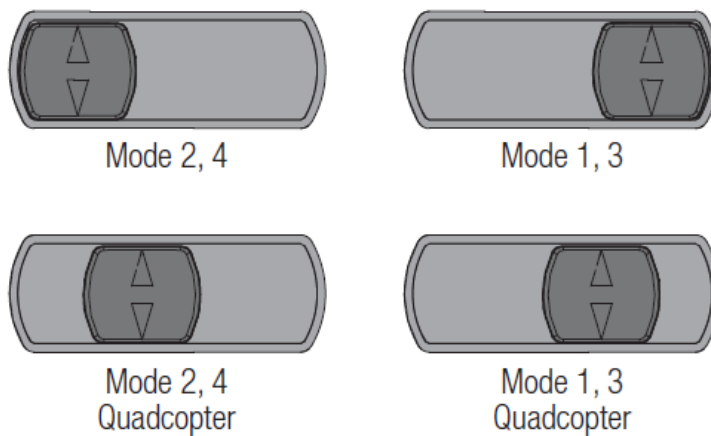

Simply open the protective slider door and move the slider to the desired position. All changes happen automatically inside the transmitter.

## Connecting Other Transmitters to RealFlight 9 RC Flight Simulator



To connect other compatible transmitters to the InterLink DX controller, and to use them within the simulation, it is necessary to use the optional interface adapter cords (purchase RFL1015). Simply plug the appropriate cord into the port on the rear of the InterLink DX, as shown above. Plug the remaining end of the interface adapter cord into the trainer port of the transmitter. The InterLink DX is now enabled as a pass through/interface unit.

For additional information on using other transmitters with the RealFlight 9 RC Flight Simulator, please refer to the Using Your Own RC Radio section of this on-disc manual.

# Basics of Flying

## *UNDERSTANDING THE FUNDAMENTALS OF RADIO CONTROL FLYING.*

**B**efore taking control of a transmitter, it helps to understand the basics of flight, and the functionality of the gimbals, sticks and switches to properly control the aircraft. This chapter reviews the basics of flying an airplane or a helicopter to help get you started down the right path.

### Airplane Basics

Before you fly the plane, make sure all switches are in their off or low rates, positions. The switches may be assigned to different items depending on how you have configured your controller and which aircraft you are flying. If you are using your own transmitter to control RealFlight, please consult your transmitter owner's manual for more information.

The InterLink DX features digital trim tabs which are more precise and offer trim memory within the simulation. Trim tabs are the small slider controls on the controller (two per controller stick). They "trim" the aircraft so that it flies straight and level. For example, if an airplane has a tendency to veer slightly downward, you may need to add a slight "up" nudge to the elevator. You can do this by sliding the elevator trim, a click or two at a time, towards the bottom of the controller.

### Crashing-

Takeoffs are optional, but landings are mandatory. For any type of aircraft or flying, successfully landing an aircraft is a crucial skill to master.

The key to a perfect landing is undivided concentration. Pay close attention to the altitude, orientation, and speed of the aircraft as it approaches the runway. Should you happen to crash, use each crash as a learning experience to perfect your approach and the landing.

RealFlight has tools to help you stay on top of things during approach and landing. See the "Landings" section below for some ideas.



Out at the field a crash might result in one or more of the following:

- Bruise your ego
- End flying for the day
- Cost you money
- Cost you time to rebuild
- Cause injury to yourself or a bystander
- Even win you a nice “best crash trophy!”

Of course, when you crash on the simulator, there is really no harm done. None, that is, except the bad habits you may acquire. We suggest that you take the crashes seriously and learn from each one. By doing so, you will be a better pilot out at the field.

### **Airplane Flight-**

The RealFlight 9 RC Simulator very accurately simulates how RC aircraft really fly. This allows you to practice RC flight without worrying about expensive crashes. Additionally, RealFlight 9 is ideal for practicing new maneuvers and experimenting with various parameter adjustments.

It is important to remember, however, that a simulator will only help you learn to fly if you let it. Otherwise, it is just a game. Learning to fly RC aircraft requires a commitment. One does not just grab the sticks and start dazzling the crowds. A methodical, patient approach will help you get the most out of this simulator.

This section is not designed to teach you how to fly. However, it will help you enhance your experience with the simulator and obtain the most from your experiences.

### **Takeoffs-**

When you are taking off, start with the throttle in low position and slowly increase throttle by pushing the throttle stick away from you towards the top of the transmitter until you are at about half speed. Stay in the middle of the runway (you can steer the plane using the rudder). When you have built up enough speed, gradually pull back on the elevator stick to climb off the runway. If the plane is tracking well, apply the rest of the power more quickly, climb out, and gain altitude.

Be careful not to veer off the runway. In a real plane, chances are that you would crash (or get stopped on the grass). Usually this means bent landing gear and a broken prop. If your plane has retracts, they could even be torn out of the wing.

## Landings-

It is very important to land on the runway, rather than veering off, or touching down before you reach the runway. Either of the latter usually produces a moderately expensive crash. If you “cartwheel” (wing tip hits the ground first), the wing can break, resulting in lengthy down time while you repair your airplane.

Start by aligning your plane parallel with the runway. Fly the approach normally, using your throttle to control the rate of descent. Try to land at the slowest speed possible. If your plane has flaps, use them to kill speed (but be careful; with flaps down your plane will try to pitch up and climb). If your plane has retractable landing gear, lower them. As you touch down, remember to keep your nose up!

Tip: While practicing landings in RealFlight, use the NavGuides during your approach to keep track of your speed, altitude, and distance above ground.

## Aerobatics-

When you practice aerobatics, the three important steps are:

- Start the plane *straight and level*, in a controlled situation
- Perform the maneuver
- Return to a straight, controlled situation

Anyone can give it full throttle, jam the sticks in all directions and watch the plane tumble and roll. However, this is *not* what you will do out in the field. Do this and you will not have control of the airplane!

The key to properly performing the maneuver is in the setup. Doing so will allow you to cleanly finish and your experience will be more rewarding as well as more realistic.

Concentrate on making the maneuvers “clean and crisp.” If you are doing a roll, try to keep the plane on a straight line as you roll. If you are doing a loop, try to make a perfectly round circle.

## Throttle Management-

Avoid the temptation of giving the plane full throttle and keeping it there for hours at a time. This teaches you bad habits and makes even a good flier look like a rookie out at the field.

Many of the maneuvers require proper throttle management in order to make a maneuver look good. Loops, stalls, torque rolls, touch-and-goes are just a few examples. Try doing various maneuvers at differing speeds. Try performing a slow roll

at medium throttle and keeping a perfectly straight line. This difficult maneuver will earn you more praise at the field than doing a full speed, full stick roll.

### **Rudder Management-**

Most airplanes can (more or less) be effectively flown with just the elevator and ailerons. Good pilots will tell you that the proper use of the rudder is just as important, however. Many aerobatic maneuvers require excellent rudder usage.

Rudder control is especially important when landing in a crosswind. Pilots that cannot use the rudder usually land in the tall grass (embarrassing!). Pilots that do use the rudder can land on the numbers almost every time.

## **Helicopter Basics**

A model helicopter is a very complicated machine, which operates on the same aerodynamic principles as its full-scale counterpart. These principles are quite complicated to explain and understand. However, it is not necessary to understand all the underlying aerodynamics in order to successfully fly a model helicopter (or a computer simulation).

The following will help you to better understand the basics of helicopter flight, and the relationship between control stick movements and the actions of the machine. Refer to these instructions often as you become more proficient.

Please note: The inputs below are shown using a Mode 2 transmitter.

## Collective (Left Stick – Vertical Movement)-

The spinning main rotor blades, which act like rotating wings, lift the helicopter into the air. Changing the pitch (angle of attack) and speed of the blades, using the “collective” and throttle causes the helicopter to rise and descend vertically. Adjusting “collective” increases and decreases the blade pitch. The “throttle” control increases and decreases engine RPM. On a model helicopter, the collective and throttle controls are mixed electronically, and controlled by the throttle stick on the transmitter or controller.



## Rudder (Left Stick – Horizontal Movement)-

To turn the nose of the helicopter left or right, change the tail rotor pitch (by using the “rudder” control). Changes in collective stick movement will require changes in the amount of rudder input to maintain the desired heading.



## Cyclic Stick (Right Stick)-

The cyclic stick replaces the “aileron” and “elevator” controls found on a fixed-wing aircraft. “Cyclic” is the term given to the control of the main rotor that allows the helicopter to fly forward, backward, left and right. Forward cyclic stick movement causes the helicopter to pitch forward, left cyclic causes the helicopter to tilt sideways to the left, on so on. You move the helicopter forward or sideways using a *coordinated* movement of both the cyclic and collective control sticks. Moving the cyclic stick to the right, while simultaneously increasing collective, will cause the helicopter to move sideways to the right. “Rudder” control is used to maintain the heading.





### Idle-Up-

A switch on the controller actuates a special function, known as “idle-up.” Idle-up offers an alternate throttle and pitch curve, different from the curves used for hovering. Idle-up is usually used for aerobatics, when the pilot wants engine power added when pitch is subtracted. For example, inverted hovering requires positive throttle and negative pitch. As such, pulling the collective stick back provides positive throttle AND negative pitch simultaneously.

## Throttle Hold-

Another special function is known as the “throttle hold”. When activated, this switch sets your throttle to idle but allows the collective to function normally. This allows you to practice autorotations without shutting the engine off.

## Gyro-

Any sudden change to the torque of the main rotor, such as a quick change in RPM or a wind gust, can cause the helicopter to turn unintentionally to an unwanted direction. An electronic device known as a gyroscope (gyro) is used to “monitor” and correct for this by giving commands to the rudder control to help stabilize the machine.

Gyros come in a variety of types, each with different features. A normal gyro will not return the helicopter to its former heading; it will simply dampen the unwanted sudden movement. We recommend you start by using the heading hold gyro instead; it will maintain course and keep the nose of the helicopter pointed in the desired direction regardless of outside forces.

# Helicopter Flight

## Hovering-

The machine hovers by adjusting the collective/throttle control to maintain altitude, the rudder to maintain heading, and minute adjustments to the cyclic controls to maintain location. Hovering is the most important aspect of helicopter flight to master, since every other movement of the machine begins and ends with a hover.

## Forward Flight-

The helicopter moves forward by changing cyclic (moving the cyclic control forward). This causes the rotor head, and thus the helicopter to tilt forward, resulting in a forward thrust. As the cyclic increases, the collective must also be increased to maintain the desired flight path. As forward speed increases, the collective can be reduced slightly.

## Backward Flight-

Backward flight is accomplished by moving the cyclic control aft, which causes the rotor head, and thus the helicopter to tilt backward. As the cyclic is moved aft, the collective must also be increased to maintain desired flight path. As backward speed increases, the collective can be reduced slightly.



## Sideways Flight-

Moving the cyclic control left will cause the rotor head, and thus the helicopter to tilt left. Add collective and left rudder to cause the helicopter to “slide” sideways to the left. As speed increases, it will require progressively more rudder to maintain heading.

To move right, simply follow the same procedure, but reverse the cyclic and rudder movements (move cyclic right, apply right rudder).

## Turning-

### From forward flight-

Moving the cyclic control left, while applying a small amount of aft cyclic and feeding in left “rudder”, will cause the helicopter to make a coordinated turn to the left. Right movement of the cyclic and rudder sticks will cause the heli to turn to the right.

### From a hover-

Use the rudder to rotate the nose of the helicopter in the direction you want.

Learning to fly a model helicopter is more difficult and challenging than any other genre of radio control modeling, but is also the most rewarding as you master the techniques required for sustained hover and forward flight. Computer simulation of model helicopter flight is an excellent tool for learning the basics and dramatically reducing the learning curve when you move on to the actual model itself.

# RealFlight 9 Launcher\*

[\*DVD and Tower Hobbies Digital versions only]

**THE REALFLIGHT 9 LAUNCHER IS THE GATEWAY TO SIMULATOR FUN!**

This item allows you to run the simulation, register and update the software, and much, much more.

To run RealFlight or to access the additional options, click the **RealFlight 9 Launcher** icon located on your desktop.



## Run RealFlight

To start running RealFlight, double-click the **RealFlight 9 Launcher** located on your desktop. Next, click the **Run RealFlight** button. The simulation will begin loading the terrain, airport objects, textures, etc. Your simulation experience will begin as soon as the loading process completes.

### RealFlight Update-

If an update exists for your RealFlight 9 RC Simulator, an on-screen indication will appear just beneath the Run RealFlight button. With your RealFlight computer connected to the internet, simply double-click the on-screen indication and the simulator will automatically update the necessary files accordingly.

### RealFlight Manual-

Press the **RealFlight Manual** button to bring up the manual, this document that you are reading now, for the RealFlight 9 RC Simulator.

## Technical Support-

[Steam version: Some of the following buttons are not present.]

Press the **Technical Support** button to bring up technical support information pertaining to your system. If you encounter any difficulties with RealFlight, this information can help you to resolve the situation on your own, or may assist Horizon Hobby's Support Staff to diagnose the problem for you.

This dialog is also accessible via the Technical Support Help menu item in RealFlight.

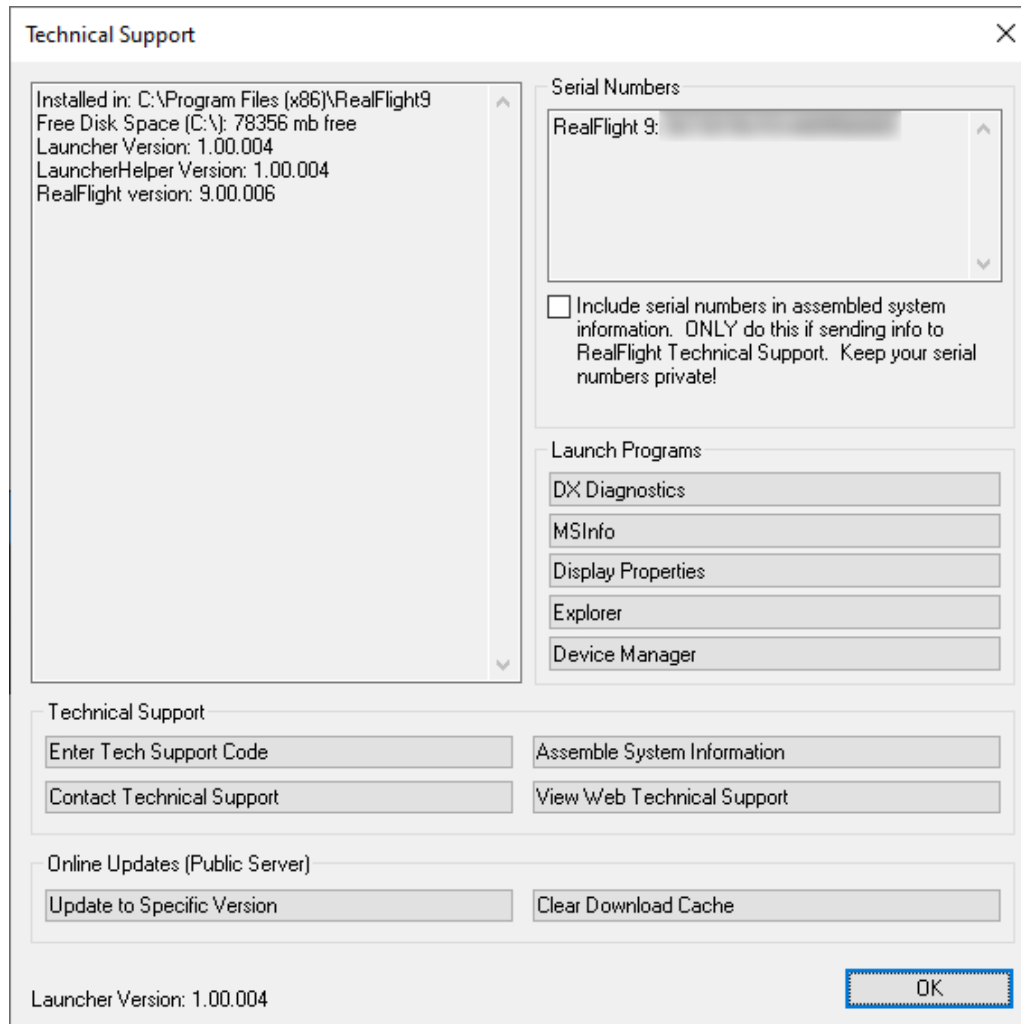

## System Information Panel-

The panel on the upper-left portion of the window displays a list of the RealFlight information as it pertains to your system.

### **Serial Numbers Panel-**

The panel on the upper-right portion of the window displays a list of the RealFlight serial numbers for the product that has been installed on your system.

### **Include Serial Numbers-**

This checkbox determines whether or not the serial numbers for the RealFlight items are included with the Assemble System Information when this information is sent to the Horizon Hobby Technical Support Staff.

This information will, of course, remain private between Horizon Hobby and the owner of the RealFlight software. We recommend enabling this as it can greatly assist in the identification and remedy of any difficulties that might occur.

## **Launch Programs-**

### **DX Diagnostics-**

This brings up Microsoft's DXDIAG utility. Using this utility can further help diagnose your system.

Please note: If you send us information about your system to help us diagnose a problem, please *do not* use DXDIAG to generate that information. Instead, use the "Assemble System Information" option. The "Assemble System Information" output file contains more information than the DXDIAG output.

### **MSInfo-**

This option will run MSInfo. This will give you even more information about your system. This program is not always installed on a particular computer, but normally comes with programs such as Microsoft Office®.

### **Display Properties-**

This brings up the display properties for your monitor. You can use this page to change the resolution of your desktop.

### **Explorer-**

This button launches Windows Explorer. This Microsoft Windows utility can help you locate, move and back up your files.

### **Device Manager-**

This button launches the Device Manager. This Microsoft Windows utility will help you determine driver dates, as well as installing and updating video and sound card drivers.

### **Technical Support-**

As the title suggests, the items in this section are designed to assist with any difficulties that might arise with the application of the RealFlight 9 software on your PC. The

buttons will efficiently and effectively gather necessary information and enable you to contact our staff accordingly.

### **Enter Technical Support Code-**

Choose this option to enter a technical support code. If you do encounter problems running RealFlight, our Technical Support team may supply you with a code to input here. Entering this code will help them diagnose or even resolve your difficulty.

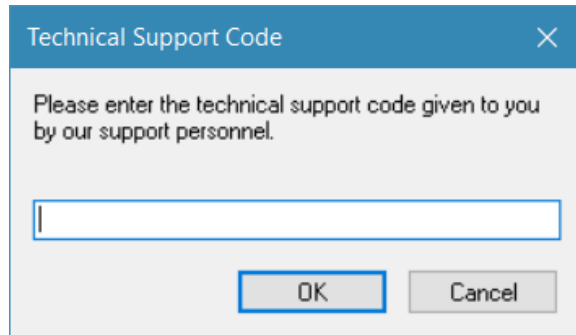

### **Contact Technical Support-**

This gives you the email address [rfsupport@horizonhobby.com](mailto:rfsupport@horizonhobby.com) to which you can email your difficulties. If you do email us, please be sure to attach the Assemble System Information output to your email.

You will receive an auto-reply message back confirming that Horizon Hobby's Support Staff received your email. If you do not receive the auto-reply message, please double-check that you sent your email to the correct email address.

### Assemble System Information-

Choose this option to collect critical information about your system, and about your RealFlight settings. You may find this information useful if you try to troubleshoot problems on your own. Moreover, if needed you can cut and paste this information into an email to Horizon Hobby's Support Staff.

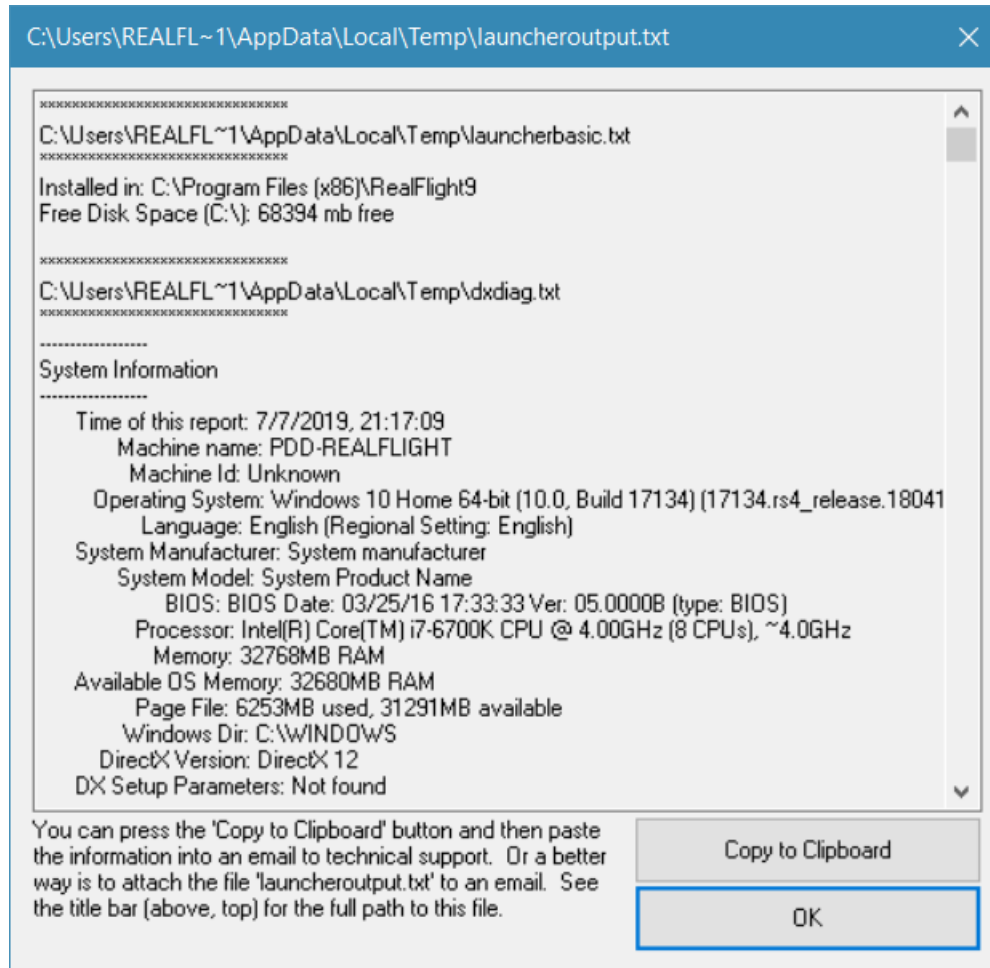

### View Web Technical Support-

Choosing this option will open a browser window, and take you to a web site that contains the most up-to-date technical support information for RealFlight.

## Online Updates (Public Server)-

### Update to Specific Version-

After registering (you only need to register once), you may update to the latest version of the software. This will download all necessary files and correctly install the upgrade.

Click this button to update to the latest version of RealFlight 9.

Please note: Your PC must be connected to the internet in order to check for updates.

#### Registration Information-

The first time that you access the Update to Specific Version button, a Registration Information screen will appear. This screen enables you to input your data which will be used in the future to assist with any technical questions that might arise.

#### Password-

RealFlight enables the user to create a password specifically for RealFlight. This will prevent others from registering this serial number should you inadvertently misplace your RealFlight DVD.

If you forget your password, contact the Horizon Hobby Software Support team. To do so, email them at [rfsupport@horizonhobby.com](mailto:rfsupport@horizonhobby.com). They will confirm your identity, and reset your password.

#### RealFlight Newsletter-

Periodically, Horizon Hobby may send out an electronic newsletter to customers that are subscribed. The newsletter includes information about new products, shows we are attending, tips and tricks and other useful items. If you wish to receive this newsletter check the box labeled **Yes, I want to receive the RealFlight newsletter via email.**

#### Hardware Information-

RealFlight 9 offers the option of automatically sending us information pertaining to your system hardware and settings when you register. If you leave the Send Hardware Information box checked when you register, RealFlight 9 will send us this information.

This hardware information will assist us in diagnosing any problems you may encounter later, should you need to contact Technical Support. Consequently, we suggest that you leave this box checked when registering.

This feature is optional. If you uncheck the box, RealFlight 9 will not send us any information about your system. Alternatively, you can view exactly what information RealFlight will send us before you decide. To view the information, click the **Technical Support** button on the main RealFlight 9 Launcher window. When the Technical Support page appears, click **Assemble System Information**.



### Clear Download Cache-

Occasionally, files may become corrupt during a download. If you are having difficulties with the online updates, remove all cached files using this option. Next, choose **Update to Specific Version** and then select the **Completely Refresh** option.

### Restore Defaults-

Use this button to restore the RealFlight 9's default settings. Doing so will NOT remove custom aircraft, flying sites, etc. Rather, it is designed to simply restore the factory default values and settings for the simulation.

This functionality is also accessible via the Reset to Defaults in RealFlight.

### Uninstalling RealFlight-

Click the **Uninstall RealFlight** button to uninstall the software. The following dialog will appear:

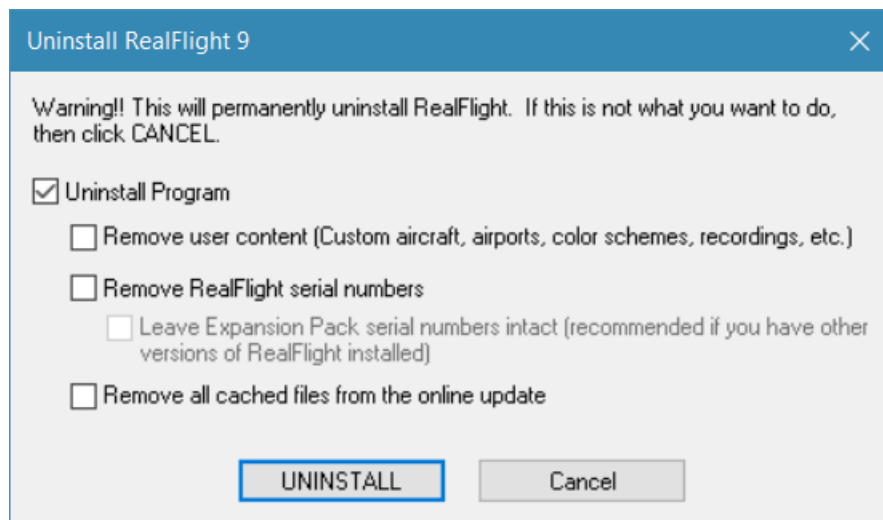

The RealFlight 9 Launcher will remove all necessary RealFlight 9 files.

### Uninstall Program-

Choose this option to uninstall only the RealFlight 9 program itself.

### Remove user content-

Choose this option to uninstall any user files such as customized airports, customized aircraft, color schemes, etc. *Be careful with this option!* These files are unrecoverable after being uninstalled. You could lose a lot of your work by inadvertently uninstalling these files.

### **Remove Serial Numbers-**

Choose this option to remove the serial numbers from your system. This will remove the RealFlight serial number as well as your online activation. Since RealFlight Expansion Packs may also be installed on your computer for previous versions of RealFlight, you may wish to leave those serial numbers untouched. To do so, click the box **Leave Expansion Pack serial numbers intact**.

### **Remove All Cached Files From The Online Update-**

Choose this to option to remove all cached download files from your system. If you uninstall these files, future downloads may take a little longer.

# If You Experience Difficulties

## *TIPS AND TRICKS FOR SOLVING THE MORE COMMON PROBLEMS.*

**T**he RealFlight 9 simulator is on the cutting edge of technology, and therefore operates using advanced hardware. Consequently, there is always the remote possibility you may experience a few slight difficulties. Should the need arise, we provide extensive resources to help.

Besides providing arguably the best RC simulator, we sincerely feel that we provide the best, most extensive product support of any RC simulator. Since cards, drivers, and operating systems are always changing, we work hard to keep our support team up-to-date on the latest information available to ensure that you have the most enjoyable experience possible.

This section begins with a summary of the various sources of RealFlight 9 information including support and problem solving assistance. Then, we will show you some simple but powerful steps that can resolve or prevent most RealFlight 9 difficulties. Finally, if these steps fail to solve your difficulty, we will explain the most effective ways to acquire additional assistance.

## How to Get Help and Information

As a RealFlight 9 user, you have access to an incredible amount of information about this product. Much of this information can help you resolve difficulties, or correctly access and use program features. Here is where you can find it:

- The manual. Most common RealFlight difficulties can be resolved by following the instructions in later sections of this chapter; however there is also additional information throughout other chapters that may be of assistance.
- Visit our product Knowledge Base at: <https://realflight.com/support/kb/index.php>. This is a great resource and is an indexed, searchable collection of articles that describe solutions to almost every known situation with RealFlight and all of our other software

products. In fact, this is the same information database used by our product support technicians.

- Visit the Knife Edge Software Message Boards at [www.knifeedge.com/forums/](http://www.knifeedge.com/forums/). This is a place where owners of RealFlight and other Knife Edge products post questions, comments, and responses. Sometimes our product support technicians and product developers from Knife Edge post replies and announcements as well. You may find a thread that discusses the same difficulties that you are experiencing.
- Contact our Technical Support department by email at: [rfsupport@horizonhobby.com](mailto:rfsupport@horizonhobby.com). Alternatively, our staff is also available via telephone or postal mail at:

RealFlight Technical Support  
2904 Research Road  
Champaign, IL 61822 USA  
Voice phone: 877-504-0233

The product support teams are specially trained, and have many resources to help you resolve problems with RealFlight 9.

## Before You Do Anything Else

If you are experiencing difficulties with RealFlight 9, you should always try the steps below first. These steps really do cure most problems our users experience. Even if you are not having a problem, these same steps often assist in the operation of both RealFlight and your computer.

- Update your video and sound card drivers (see instructions below).
- Update to the latest version of RealFlight 9.
- If these steps do not work, proceed to the next section.

### Update Your Drivers-

Before you do anything else, you should make sure you have updated your video and sound drivers. A large number of difficulties encountered by RealFlight users can be cured by updating drivers.

A driver is a software program that controls your video or sound card. Each card manufacturer provides drivers for its own cards. To work correctly, RealFlight relies on your video and sound card drivers.

It is very important to use the latest available driver for your card. Card manufacturers frequently release updated drivers to fix problems that occur when the driver is used with programs such as RealFlight 9. The driver that came with your new computer, on your Windows disc, or on the disc included with the new card you bought, may not be the latest version.

If you do not know how to update drivers, you can find instructions in our Knowledge Base article *Q01-1038, How to Update Drivers*, at <https://www.realflight.com/support/kb/article.php?p=RF8&q=01-1038>. This page will take you through the process step-by-step, and has links to driver download sites for most manufacturers.

## Update to the Latest Version of RealFlight 9-

As we regularly release program updates, the difficulty that you are seeing may already be fixed in an update. Even if you just bought RealFlight, you should update to the latest version. It's free and only requires a few minutes of your time.

## If You Need Additional Assistance

You have updated drivers and updated RealFlight 9 and you are still having problems. What next?

As a first step, we suggest checking our Knowledge Base at <https://www.realflight.com/support/kb/index.php>. This is an easy to use, searchable database of known problems and solutions for various iterations of RealFlight as well as some of our previously released software such as RealRace. This is the same database that our Product Support technicians use when helping customers. We constantly update the knowledge base to address new problems as we discover them. In many cases, you will be able to find an article that gives clear, concise instructions for resolving your difficulty.

You may also want to check the Knife Edge Message Boards at [www.knifeedge.com/forums/](http://www.knifeedge.com/forums/). This is a place where owners of RealFlight and other Knife Edge products post questions, comments and responses about problems. You may find a discussion thread about the problem you are experiencing.

You can also contact Technical Support at Horizon Hobby via email at: [rfsupport@horizonhobby.com](mailto:rfsupport@horizonhobby.com).

IMPORTANT. If you do contact Technical Support, you can help us enormously by providing detailed information about your computer system. Since your problem may only occur on a particular video or sound card, particular driver version, etc., we may need this information to help us diagnose your problem. To compile your system information, use the **RealFlight 9 Launcher**. Click the **Additional Options** button. Next, click the **Technical Support** button, followed by the **Assemble System Information** button. This will create a file called "c:\launcheroutput.txt", which contains your system information. Attach this file to an email and send it to us at [rfsupport@horizonhobby.com](mailto:rfsupport@horizonhobby.com).

## Examples of Common Problems and Solutions

### If You Don't See Your Problem in This Chapter-

This chapter contains a few examples of common difficulties and concerns that RealFlight users have experienced.

Remember that we can never provide a complete list of difficulties and solutions in a program manual. That's because RealFlight - and the computers, cards, and drivers it uses - are constantly evolving. As such, we maintain a detailed Knowledge Base at <https://www.realflight.com/support/kb/index.php>. By keeping our Knowledge Base online, we can provide you with the latest information about resolving any difficulties that might arise. If you don't see your difficulty described in this chapter, please check the Knowledge Base.

In this chapter, we've simply tried to pick a very short list of the most asked about issues.

### My computer "freezes" when I run RealFlight-

Sometimes, you may also notice sound skipping or repeating, or a computer reboot while flying. To resolve this type of problem, you must update the drivers for your video and sound cards. **This is very important.** Card manufacturers regularly update their drivers to fix this type of problem. Even the driver that came with your new computer may not be the most recent.

Sometimes a card manufacturer will offer a choice between a "recommended" driver, and another driver (often called "special purpose", "alternate", or "beta" driver). If RealFlight 9 "freezes" with the "recommended" driver, try using the alternate driver instead.

If you are sure that you are using the latest drivers, and have followed all the other steps in the previous section (update RealFlight 9, test DirectX) and are still having difficulty with your computer locking up while running RealFlight, please contact Horizon Hobby's technical support staff.

## Improving RealFlight 9 Performance-

During installation, RealFlight 9 analyzes your computer's hardware specifications. RealFlight 9 then tries to optimize its configuration to best take advantage of that hardware, and achieve the best possible performance.

However, if the performance is less than you desire, you can adjust some of RealFlight 9's settings to improve the simulation speed and frame rate:

- Ensure that the drivers for the video and sound cards are up-to-date.
- Turn off all other programs, especially virus checkers and network applications (such as Instant Messengers) while running RealFlight 9. Use **CTRL-ALT-DELETE** and check the Task Manager to verify that nothing else is running in the background.
- Reduce the texture, water, shadows and other graphics quality in RealFlight. This can have a profound effect on cards that do not have a high texture memory. See the Settings section starting on page 80 for more information.
- Eliminate the items shown in the simulation. To do so, access the **View** menu title then, access the **Scenery** menu item. Click an item, type to remove it from the simulation. It may be necessary to eliminate several items before performance meets your expectations.
- Reduce the number of open Gadgets and Viewports. Click the '**X**' on each Gadget or Viewport that you wish to close.

## Other Common Problems-

Here are some other things you may want to watch for:

- Check the DVD for scratches or blemishes. Even minor scratches or fingerprints can cause random problems that appear to be program bugs. [DVD version only.]
- Verify that all other programs are closed prior to starting RealFlight 9. RealFlight works best when it is the only program running.
- If all else fails, try rebooting your computer occasionally, Windows may become unstable after prolonged and continuous use. A simple reboot may clear up any difficulty.

# Transmitter Modes

**T**hroughout world, pilots will fly using radios in different Modes. The Mode refers to the transmitter’s gimbal stick assignments which determine the flight mode of your controller. There are two main modes of control. Mode 1, mostly used in Europe, and Mode 2 which is the predominant method of controlling aircraft.

### Mode 1-

A controller which is designated as Mode 1 means that it contains the throttle and aileron on the right stick. The left stick will, therefore, control the elevator and rudder.

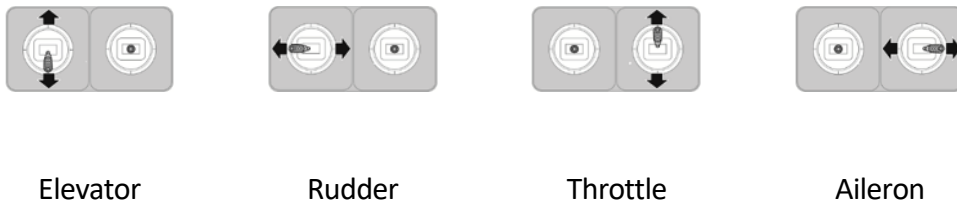

### Mode 2-

A controller which is designated as Mode 2 will have the left stick controlling the throttle and the rudder. Conversely, the right stick will control the elevator and the ailerons.

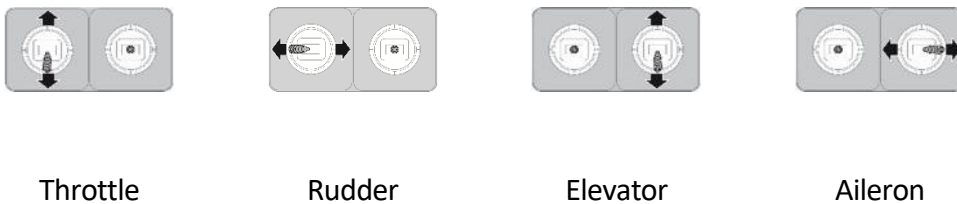

### Configure RealFlight-



Once you have made the changes to your InterLink DX controller, you will now need to make some minor changes in RealFlight to match your controller's configuration.

First, adjust the channel mapping by editing the InterLink DX Profile. See Select Controller section on page 53 for more information about his process.

Last, make sure the on-screen Radio Gadget is also switched to Mode 1, found under the Gadgets menu. See Radio Mode on page 213 for more details.

# Glossary

## **180-Degree Turn**

RC Term

This basic flight practice starts with a takeoff, and then demonstrates 180 degree turns on a flight path parallel to the runway.

## **360-Degree Turn**

RC Term

In this practice, you will learn to fly the aircraft in a complete circle (360-degree turn). This maneuver is a great way to learn control inputs for turns while maintaining a constant radius and altitude.

## **3D Acceleration**

Computer Term

3D rendering requires a huge number of calculations. Modern computers offload many of these calculations to the video card, rather than performing the calculations directly on your computer's CPU. This speeds up the simulation and allows for faster frame rates, thereby increasing the realism of the simulation.

## **ATV**

RC Term

Amount of servo travel. For instance, 50% ATV would mean the servo's maximum travel is 50% of its physical limit.

## **AccuModel**

RealFlight Term

RealFlight 9's AccuModel aircraft editor offers the most powerful, most flexible aircraft editor ever released in an RC simulator.

## **Active View**

RealFlight Term

The active view is the view that is affected by the commands in the View menu. Only one view at a time is active. You can make a view active by clicking on it with the mouse. When you want to control a view's properties, you must first make it the active view.

## **Advanced Flight Recorder (AFR)**

RealFlight Term

This feature allows the pilot to not only view prerecorded maneuvers, but also allows them to record their own. During the playback of maneuvers, the pilot has the ability to select from a number of different options such as fast forwarding, rewinding, looping, speeding up, and slowing down the recordings. These recordings may also be sent to others via the Internet. The pilot can also activate an on-screen transmitter to watch the stick inputs for each pre-recorded maneuver.

## **Adverse Yaw**

RC Term

The tendency of an airplane to yaw in the opposite direction of the roll. For instance, when right aileron is applied, the airplane yaws to the left, thus opposing the turn. Adverse yaw is common in trainer type airplanes having flat bottom wings. It is most noticeable at slow speeds and high angles of attack, such as during takeoffs and when stretching a landing approach. Caused by the unequal drag of the upward and downward deflection of the ailerons, this undesirable trait can be minimized by setting up the ailerons with Differential Throw or by coordinating the turns, using the aileron and rudder controls simultaneously.

## **Aileron**

RC Term

Hinged control surfaces located on the trailing edge of the wing, one on each side, used to provide control of the airplane about the roll axis. The control direction is often confusing to first time modelers. For a right roll or turn, the right hand aileron moves upward and the left hand aileron moves downward. The movements are reversed for a left roll or turn.

## **Airfoil**

RC Term

A surface (such as a wing or propeller blade) with a shape that produces a force perpendicular to its motion called lift.

**Airframe**

RealFlight Term

A term used to describe the general components of an aircraft when using RealFlight 9's AccuModel aircraft editor. For example, selecting the airframe will call up the fuselage, wing(s), and tail of an airplane.

**Angle of Attack**

RC Term

The angle that the wing penetrates the air. As the angle of attack increases so does lift and drag, up to a point.

**Arm**

RC Term

In this context, the arm is the distance from the point of the application of a force to the axis of rotation. If you press down on the tip of a wing, for example, the arm is the distance from the point where you are pressing to the root of the wing.

**AS3X**

RC Term

Exclusive technology available from Horizon Hobby. Spektrum's AS3X (Artificial Stabilization-3 aXis) smooths out the effects of wind and turbulence. It also includes option-use SAFE (Sensor Assisted Flight Envelope) Select technology. For more information, please refer to the SAFE Select definition.

**Auto-Play**

Computer Term

A Windows feature that automatically detects when a CD or DVD is inserted and runs the specified program on that disc.

**Autorotation**

RC Term

A maneuver in which the pilot attempts to bring the helicopter in for a landing without power from the engine. The momentum of the spinning rotor blades is enough to slow the helicopter prior to landing.

**Autorotation Event**

RealFlight Term

An event where players attempt to autorotate onto a target (similar to Spot Landing). Each player takes a turn. Players collect different point amounts based on landing location. The Autorotation Event works for helicopters only. The Deadstick Event is for airplanes.

**Avalanche**

RC Term

The Avalanche is a loop with a snap roll at the top of the loop. This snap roll must be centered at the top of the loop.

**Bloom Effect**

RealFlight Term

The effect creates a feathering of light around brighter objects, giving it a more realistic look. This is more noticeable at brightly lit airports around aircraft that are lighter in color.

**Camera Lag**

RealFlight Term

This parameter determines how quickly or slowly the camera (your view of the aircraft on the screen) reacts to the aircraft's movements.

**Channel Mapping**

RealFlight Term

This term describes the ability of RealFlight 9 to alter the mapping or input of the servos to accurately reflect the actual controls from an RC controller.

**Chat**

RealFlight Term

This is a real-time communication between two or more RealFlight 9 users which is conducted via the PC. RealFlight 9's multiplayer feature enables a public chat if so desired.

**Child/Children Item(s)**

RealFlight Term

In many of RealFlight 9's selection windows, items are displayed in a hierarchy format. An item that belongs to a higher group, or parent, is considered the child item.

**Chord**

RC Term

The chord of a wing or surface is the width of the surface. A wider chord offers increased lift. However, a wider chord also generates more drag when the aircraft rolls.

**CG**

RC Term

CG is the abbreviation for the phrase Center Of Gravity. This is the point at which the aircraft balances fore to aft and side-to-side. The location of this point is crucial to how the aircraft reacts in the air. For airplanes, a tail-heavy plane will be very snappy, but generally unstable and susceptible to frequent stalls. Conversely, a nose-heavy plane will tend to track better and be less sensitive to control inputs, but will generally drop its nose when the throttle is reduced to idle. This makes the plane more difficult to land, since it takes more effort to hold the nose up. A nose heavy airplane will have to come in faster to land safely.

**Collective**

RC Term

A mechanism on a helicopter that changes the pitch of the main blades, thereby allowing the helicopter to ascend or descend accordingly. This is the control that adjusts the pitch of the rotor blades.

**Collision Detection**

RealFlight Term

RealFlight 9 sports the most advanced collision detection modeling ever used in an RC model simulation. It blankets the entire aircraft, ensuring accurate modeling of the aircraft when it collides with objects and items within the simulation.

**Coning**

RC Term

When a helicopter hovers, the blades form a slight "cone" when viewed from the side. The Coning effect is caused by the balance between lift and centrifugal forces on the blades.

**Console**

RealFlight Term

The Console (found by pressing the ~ key on the keyboard) allows for command line functions used by advanced users. For example, type in fruitcups and then press the Enter key.

**Control Surface**

RC Term

Generally defined as the portion of the airfoil that moves. Examples include ailerons, elevators, rudders, flaps, and spoilers.

**Controller**

RealFlight Term

A device used to control an aircraft in RealFlight. RealFlight 9 ships with the USB Spektrum InterLink DX controller developed by Horizon Hobby and Knife Edge Software. This device can be used as a standalone controller, or as an interface to use your own RC transmitter.

**Cuban Eight**

RC Term

Model enters in level flight, pulls to complete 5/8s of a loop to the 45 degree down line, completes ½ roll, pulls to complete 5/8s of a loop to the 45 degree down line, complete ½ roll to complete 3/8s of a loop to level flight.

**Cyclic**

RC Term

For helicopters, this refers to the tilting forward and back (pitch), or tilting sideways (roll) of the helicopter. To do this, the angle of attack of the main rotor blades is changed during rotation, creating different amounts of lift at different points in the cycle.

**Deadstick**

RC Term

A term used to describe unpowered flight (glide) when the engine ceases operation.

**Depth of Field**

Computer Term

The depth of field (DOF) is the portion of the screen that appears sharp, while all other objects appear out of focus. In RealFlight, depth of field can add more depth perception to your computer monitor, which is flat.

**Dihedral**

RC Term

The V-shaped bend in a wing. Increasing the dihedral usually enhances the aerodynamic stability of an airplane, and helps the rudder to control both the roll and yaw axis. This is why some trainers and sailplanes require only three channels of radio control (i.e., they have no ailerons).

**Direct Control Interface**

RealFlight Term

This is a method for using your own radio to completely control the aircraft. This usually means you have a separate radio program on your radio for each aircraft that you want to fly in RealFlight 9 with this method. All mixing and radio functions are performed on your radio and RealFlight simply passes the values directly to the aircraft servos. This is in contrast to the Joystick Emulation Interface.

**Direct3D Technology**

Computer Term

A Microsoft DirectX technology used to render the 3D image when you have a graphics accelerator card. It works best on faster computers.

**DirectX**

Computer Term

A technology created by Microsoft that controls graphics and sound operations.

**Dithering**

Computer Term

A method of removing and/or simulating colors that may not be available to the graphics processing unit.

**Down Thrust**

RC Term

This is the downward angle of the engine in relationship to the centerline of the airplane. Down Thrust helps overcome the normal climbing tendency of flat bottom wings.



**Driver**

Computer Term

A software program that controls a card (e.g., video or sound card) in your computer. Card manufacturers usually provide drivers as well. Card manufacturers frequently update their drivers to fix bugs or to make their cards compatible with new software and hardware. You can often find an updated driver for your video or sound card by visiting the card manufacturers web site and following links to “Drivers,” “Support,” “Downloads”, or “Upgrades.”

**Edit NavGuides**

RealFlight Term

A NavGuide is a gadget that displays continuously updated information about your aircraft. The Edit NavGuides dialog is used to customize the NavGuides gadgets.

**Elevator (Maneuver)**

RC Term

The Elevator is a maneuver in which the aircraft is made to stall completely with a large amount of elevator throw. The aircraft will descend almost vertically much like an elevator. To perform the Elevator, make sure that you have sufficient altitude, dive the aircraft vertically toward the ground and pull full up on the elevator stick.

**Elevator (Control Surface)**

RC Term

Hinged control surface located at the trailing edge of the horizontal stabilizer, which provides control of the airplane about the pitch axis and causes the airplane to climb or dive. The correct direction of control is to pull the transmitter Elevator control stick back, toward the bottom of the transmitter, to move the Elevator upward, which causes the airplane to climb. Move the Elevator in the other direction to dive.

**Endpoint Adjustment**

RC Term

This radio feature adjusts the length of servo travel in one direction (a single channel will have adjustments for two endpoints). For example, if your aircraft rolls faster one way than the other, endpoint adjustments can correct the problem.

## **Exponential**

RC Term

A feature commonly found on computer radios that desensitizes the servo when the sticks are close to the neutral position. The further the stick's position from center, the faster the control response.

## **Figure 8**

RC Term

This is an excellent maneuver to learn perspective and orientation of the aircraft from all angles. Use the ailerons and elevator to turn the aircraft left and right. Use the elevator to ensure that the aircraft maintains a constant altitude, forming an '8' in the sky.

## **Flap**

RC Term

For Airplanes: hinged control surface located at the trailing edge of the wing inboard of the ailerons. The Flaps are lowered to produce more aerodynamic lift from the wing, allowing a slower takeoff and landing speed. Flaps are often found on scale models, but usually not on basic trainers.

For Helicopters: Flapping is an up-and-down motion of the main rotor blade's tip. With a "dual-damped" head, both blades are able to Flap independently. With "solid axle" heads, moving one blade up causes the other to move down.

## **Flapping Head**

RC Term

This describes a type of rotor head in which the two blades are not connected directly. Each blade is independent of the other, usually resulting in a helicopter with smoother performance.

## **Flare**

RC Term

The point during the landing approach in which the pilot increases the amount of up elevator to smooth the touchdown of the airplane.

**FlexiField**  
RealFlight Term

FlexiField is the most advanced flying site editor ever unveiled. It presents the modeler with the ability to adjust the flying site in virtually any manner desired. The user can add trees, selecting the type, size, and color; add, move, size, and orient buildings, walls and other scenery objects; position and orient the runway; even choose the amount and type of lighting at the flying site.

**Flight Failures**  
RealFlight Term

RealFlight 9 authentically recreates common difficulties that may be experienced at your local flying site. Practicing with flight failures enabled, is a good way to practice for emergencies.

**Flight Playback Gadget**  
RealFlight Term

A gadget that lets you control playback of flight recordings using mouse actions.

**Float Fly**  
RC Term

The ability to takeoff and land a radio controlled aircraft from water.

**Flybar Paddles**  
RC Term

These are the short blades on the end of the flybar. Available in a variety of weights and airfoils, these paddles assist the main blades in producing lift, etc.

**Flybarless**  
RC Term

As the name suggests, a flybarless aircraft is a helicopter that does not incorporate a flybar in the rotorhead design. Rather the helicopter uses an electronic stabilization device that electronically replaces the flybar.

**Four-Point Roll**  
RC Term

These maneuvers are very similar to a slow roll with the exception of a hesitation at either  $\frac{1}{4}$  of the roll or at  $\frac{1}{8}$  of the roll. It is important to remember to use rudder and elevator to keep the aircraft flying in a straight line.

**Frame Rate**

Computer Term

Frame Rate is the number of times per second that RealFlight creates a different picture to display on your monitor. Frame rate is determined by the speed of your CPU and graphics card, and how many RealFlight options you turn on. This is not the same as refresh rate, which is the number of times per second that your monitor retraces an image on its screen.

**Fuselage**

RC Term

Generally speaking, this is the main part of the airplane that holds the wings and engine. The fuselage is often thought of as the “body” of the airplane. This term is also used to refer to a “body” that might be used on helicopters.

**Gadget**

RealFlight Term

An on-screen display that shows you continuously updated information about your aircraft, or lets you control RealFlight features using mouse clicks.

**Global Wind**

RealFlight Term

This term describes the overall wind conditions in the simulation.

**Goldfish**

RC Term

Entering at level flight, pull 45 degrees up; perform  $\frac{1}{2}$  roll centered on the line. Then perform a  $\frac{3}{4}$  loop back to a 45 degree up line. Finish with another  $\frac{1}{2}$  roll centered on the up line.

**Governor**

RC Term

A device used to help maintain a constant RPM (head speed), generally used in helicopters rather than airplanes.

**Grouping**

RealFlight Term

A collection of scenery objects or foliage objects in your airport. Every object in the airfield must belong to one Group. You can place all of your airport's scenery objects in a single Group, or create multiple Groups to place objects in categories with related objects. For example, you could have a Group for Trees and another group for Buildings within a particular airport.

**Gyro**

RC Term

A device, most commonly used in helicopters, that aids in controlling the yawing action of the helicopter by automatically adjusting the deflection of the tail rotor blades.

**HAL Device**

Computer Term

A hardware-accelerated 3D video card driver. “HAL” is an abbreviation for the phrase “Hardware Abstraction Layer” that uses software drivers to communicate between RealFlight’s software and the hardware of the PC.

**Harrier**

RC Term

A Harrier is a slow forward progression of the aircraft with the nose held high. Use the elevator to stall the forward progress of the aircraft. Add in more up elevator until the nose approaches 45 degrees. The throttle should be used to control the forward progress of the aircraft, without climbing.

**Host**

RealFlight Term

In RealFlight 9, every multiplayer session requires one player to serve as Host. The Host starts the session, and then the other players join. Other players can leave the session whenever they want, but only the Host can terminate the entire session.

**Hub**

RC Term

The centralized mechanical device used to attach the main rotor blades and paddles.

**Humpty-Bump**

RC Term

This aerobatic maneuver consists of two vertical lines connected by a half circle flown across the top.

**IP Address**

Computer Term

Whenever your computer is connected to the internet, it has an IP address. This number is a string of digits and periods, and looks something like “123.45.6.78”. The IP address is like an internet “zip code” that tells other computers where to look for your computer. Depending on your internet connection, your IP address may always be the same, or may change each time you connect to the internet.

**Immelman Turn**

RC Term

The aircraft will enter a half loop from straight and level flight followed immediately by a half roll to straight and level flight.

**Interface Mode**

RealFlight Term

With RealFlight 9 set to Interface Mode, you are using the InterLink DX Controller as an interface to your own RC radio. In Interface Mode, your own radio controls RealFlight 9. Conversely, in Joystick Mode the InterLink-X Controller (used as a mockup of an RC transmitter) controls the RealFlight 9 aircraft.

**InterLink DX Controller**

RealFlight Term

Horizon Hobby’s USB InterLink DX Controller is a USB device shipped with RealFlight 9 and available separately from Spektrum (SPMRFTX1). The InterLink DX Controller can be used as a standalone “mockup” RC controller or as an interface for connecting your own RC transmitter to control the action in RealFlight!

**Joystick**

Computer Term

A device that connects to your computer to provide control input for the simulated aircraft. The InterLink DX controller that comes with RealFlight 9 is considered a Joystick.

## **Joystick Emulation Interface**

RealFlight Term

A term used to describe using your own radio to emulate the Interlink Joystick. This allows you to use your own radio to fly any of the stock aircraft in RealFlight 9. Actual radio functions such as mixing and ATVs are performed in the RealFlight software, not on your radio. This is in contrast to the Direct Control Interface.

## **Joystick Mode**

RealFlight Term

With RealFlight 9 set to this mode, RealFlight 9 is controlled by the InterLink DX controller used as a mockup of an RC transmitter.

## **Knife Edge**

RC Term

This maneuver requires the pilot to roll the aircraft 90 degrees so that the wings are perpendicular to the ground, with one wing down and the other up then, holding this position while maintaining the same altitude above ground.

## **LAN**

Computer Term

Local Area Network. This is usually a network where the computers are connected with high speed network cards.

## **Lateral Balance**

RC Term

The right-to-left or side-to-side balance of an airplane.

## **Launcher\***

RealFlight Term

The RealFlight 9 Launcher is useful for many aspects of the RealFlight 9 program, including loading the simulator, compiling system information for technical support, or uninstalling RealFlight.

[\*DVD and Tower Hobbies Digital versions only.]

## **Lead Lag**

RC Term

A helicopter term describing the hinge point where the blade attaches to the hub. This allows the blade to move forward and backward at certain times during the blades rotation.

## **Leading Edge**

RC Term

The very front edge of the wing or stabilizer. This is the edge that hits the air first.

**Limbo**

RC Term

An event (flying competition) in which pilots take turns flying their aircraft under a Limbo bar. The pilot that clears the lowest bar height wins.

**List Server**

RealFlight Term

RealFlight 9's Multiplayer function lets you publicly "post" your session, so that any RealFlight 9 user, anywhere in the world, can find out about your session and join you (assuming you have not reached the enrollment limit of your session). The place where you post your session is called a List Server. Use of the List Server is optional.

**Lithium Polymer**

RC Term

Rechargeable batteries frequently used in RC for powering an aircraft's electric motor. A lithium polymer battery offers lower weight and improved run times when compared to other rechargeable batteries.

**Low Rates**

RC Term

A switch on the radio that reduces the servo movement to much smaller extremes, thus making the model respond more slowly to a given control input.

**mAh**

RC Term

Milliamp Hour – The measurement of a battery's total capacity.

**Mixing (or Programming Mixing)**

RC Term

Two or more output channels can be coupled together to move in a desired manner when controlling input channels are activated.

**Mode**

RC Term

Also known as Flight Mode or Stick Mode, this refers to the transmitter's gimbal stick assignments (locations) which determine the flight mode of your controller. There are two main modes of control, Mode 1- mostly used in Europe and Mode 2 which is the predominant method of controlling aircraft commonly used in the United States.



**Most Recently Used (MRU)**

Computer Term

MRU refers to the list of documents which were last accessed. For RealFlight 9, MRU's appear for airports, aircraft and recordings.

**Multiplayer**

Computer Term

A RealFlight 9 feature that uses RakNet™ technology to connect with other RealFlight 9 users over a network.

**Multiplayer Session**

RealFlight Term

A network connection between RealFlight 9 users, which allows each user to fly in the same "virtual world," and allows all participants to see and interact with each other's aircraft.

**NavGuides**

RealFlight Term

A gadget that displays continuously updated information about your aircraft and the virtual world.

**Normal Mapping**

Computer Term

In 3D computer graphics, normal mapping is used to add details to shading without using more polygons.

**Parent Item**

RealFlight Term

In many of RealFlight 9's selection windows, items are displayed in a hierarchy format. An item that has an additional item within it is considered the parent item.

**PhotoField**

RealFlight Term

A technology that creates a flying field by using a panoramic photograph as a background for a flat terrain.

**Pilot Profile**

RealFlight Term

Contains miscellaneous information about the modeler such as name, location, hours logged, etc. It is a great methodology to identify yourself to others in multiplayer sessions.

**Pirouette**

RC Term

The yawing action of a helicopter that looks much like an ice skater spinning in a circle. One Pirouette is equal to one 360-degree rotation.

**Pitch Axis**

RC Term

The airplane axis is controlled by the elevator. Pitch is illustrated by holding the airplane at each wingtip. Raising or lowering the nose is the pitch movement. This is how the climb or dive is controlled.

**Plumb String**

RC Term

When you measure your aircraft for RealFlight, some measurements require that you have a reference line running straight up and down. To make such a line, we tie a weight to the free end of a string, and let the weight dangle. Because the string is then “plumb” (oriented straight up and down), it is called a Plumb String. A Plumb String is particularly useful in measuring an aircraft’s center of gravity.

**Point Rolls**

RC Term

These maneuvers are very similar to a roll with the exception of a hesitation at either 1/4 or 1/8 of the roll.

**Private Session**

RealFlight Term

A multiplayer session that is password protected by the Host. The Host must communicate the session password to each player who wishes to join the private session.

**Propeller**

RC Term

Props are generally designated by two numbers (for instance, “10 x 6”). The first number is the length (10" in the example) of the prop. The second number is the pitch or angle of the blades. In this example, the “6” represents the distance the propeller will move forward in one revolution in ideal situations.

**Public Session**

RealFlight Term

A multiplayer session that is published on a List Server and is not password protected.

**Quick Edit**

RealFlight Term

The Quick Edit gadget offers the ability to quickly modify basic parameters of an aircraft without opening the Aircraft Editor.

**Quick Load**

RealFlight Term

The Quick Load gadget allows you to quickly search and load a new aircraft or flying site through a simple search.

**QuickSelect**

RealFlight Term

RealFlight 9 InterLink DX allows you to make changes to the simulator with the controller using the buttons at the bottom. Manipulating these buttons through the on-screen QuickSelect tabs offer the ability to change aircraft, flying sites, and more.

**RAM**

Computer Term

Random Access Memory.

**ReadySelect**

RealFlight Term

This is the name given to RealFlight 9's rotating preview box. This allows a rapid view of the aircraft from all angles.

**RealPhysics 3D**

RealFlight Term

This is RealFlight's exclusive physics modeling technology. RealPhysics 3D authentically replicates the actual physics of model aircraft by performing hundreds of thousands of floating point calculations each second while delivering sizzling real time performance.

**RealRendering**

RealFlight Term

This is a term used to globally describe the cutting edge three dimensional graphics, authenticity, and realism of the simulator world in which you are being immersed during flight.

**Refresh Rate**

Computer Term

The number of times per second that your monitor retraces an image on its screen. This is different from the Frame Rate.

**Resolution**

Computer Term

When used in the context of screen Resolution, this term describes the picture quality of the screen. Lower Resolutions will produce an image that is not as sharp as higher Resolutions.

**Rewind**

RealFlight Term

By pressing and holding the Reset button on the InterLink DX controller, you have the ability to rewind your flight to any point you wish and continue on from there.

**Roll Axis**

RC Term

The airplane axis controlled by the ailerons. Roll is illustrated by holding the airplane by the nose and tail. Dropping either wingtip is the roll movement. Roll is used to bank or turn the airplane. In most airplanes, the ailerons control roll however, when the main wing has dihedral, the plane can be banked using the rudder only. Consequently, many planes with wing dihedral do not have ailerons, and the rudder controls both roll and yaw. This is one reason most trainer aircraft have a large amount of dihedral -- a plane with large dihedral can be controlled using fewer input channels.

**Rolloff Factor**

RealFlight Term

This phrase describes how rapidly the volume of a sound increases or decreases as the source draws closer or moves farther away.

**Root**

RealFlight Term

In many of RealFlight 9's selection windows, items are displayed in a hierarchy format. The upper most item in this hierarchy is considered the Root item.

**Rudder**

RC Term

Hinged control surface located at the trailing edge of the vertical stabilizer, which provides control of the airplane about the Yaw axis (causing the airplane to Yaw left or right). Left Rudder movement causes the airplane to Yaw left, and right Rudder movement causes it to Yaw right.

## **SAFE**

RC Term

SAFE technology is an advanced technology designed and refined by Horizon Hobby to assist modelers in their enjoyment of the hobby. SAFE offers three modes to assist in the advancement of flying skills:

### **Beginner Mode**

Pitch and bank angle limits prevent over-control that can result in a loss of orientation and crashes. When the control sticks are released the airplane returns to level flight on its own. Best of all takeoffs are as simple as giving full throttle and letting the airplane fly off a smooth surface or by giving it a quick hand launch, and landings are as easy as lowering the throttle and letting it glide to a landing on its own.

### **Intermediate Mode**

More freedom in pitch and bank, but still prevents over-control and does not return to level flight on its own. This mode allows you to make tighter turns in smaller areas and to climb and descend faster as your skills advance.

### **Experienced Mode**

No pitch or bank angle limits so you have complete control! You can even fly inverted/upside down and perform aerobatic maneuvers including loops, rolls, stall turns and more.

## **SAFE Select**

RC Term

SAFE Select, another Horizon Hobby exclusive technology, offers:

### **Pitch and Bank Angle Limits**

These envelope limits keep the airplane from rolling or pitching upside down. They also prevent excessive climb or dive angles.

### **Automatic Self-Leveling**

The airplane instantly returns to and holds level flight when the sticks are released and in the center position. It's also helpful for keeping the wings level during takeoffs and landings.

An electromechanical device that moves the control surfaces or throttle of an airplane according to commands from a receiver. This device does the physical work of moving parts around inside the aircraft.

## **Servo**

RC Term

See "Multiplayer Session."

## **Session**

RealFlight Term

## **Setup Failures**

RealFlight Term

RealFlight 9 authentically recreates common difficulties that may be experienced at your local flying site. Setup failures are problems where, in ideal situations, should be detected before the aircraft ever leaves the ground.

## **Sky Grid**

RealFlight Term

A grid work of lines that appear in the sky when activated. Modelers practicing precision aerobatic maneuvers will appreciate these lines as they perfect their routines.

## **Software Radio**

RealFlight Term

This term describes RealFlight 9's ability to accurately mimic a computer transmitter (complete with mixing, etc.) in the simulation.

**Sound Card**

Computer Term

A card inside your computer that controls audio (what you hear over your computer speakers). Most sound cards plug into your computer's motherboard. You can upgrade your sound card (or the software driver that controls it) without getting a new computer.

**Specular Highlights**

Computer Term

A graphics rendering technique that makes surfaces (e.g., MonoKote™) appear reflective, or "shiny" in direct light (e.g., sunlight).

**Split S**

RC Term

The Split S is another step in learning to combine loops and rolls and is a great maneuver to decrease your altitude. A half roll precedes a half loop, making the maneuver a mirror image of the Immelman. The Split S provides course reversal and an easy increase in speed.

**Stall**

RC Term

When an airplane's angle of attack is too great to generate lift (regardless of airspeed), the plane will dive and rapidly lose altitude. This is known as a stall. Every airfoil has an angle of attack at which it generates maximum lift. The airfoil will stall beyond this angle.

**Swash Plate**

RC Term

The mechanism in a helicopter rotor that turns non-rotating control movements into rotating control movements.

**Thermal System**

RC Term

This phrase describes the wind flow and effects for the thermals in RealFlight 9.

**Throttle Hold**

RC Term

This is used to keep the throttle at a set position, yet allows input to the collective of the helicopter. Generally this function is used to practice autorotation.

**Throw**

RC Term

Commonly used to describe the degree of deflection of a control surface.

**Tip Stall**

RC Term

This is when the airplane reaches its stall speed and one wing drops.

**Torque Roll**

RC Term

The Torque Roll occurs when the nose of the airplane is pointed vertically and the airplane hovers in place. The aircraft will rotate left around its roll axis.

**Touch and Go**

RC Term

Landing and taking off without a pause, often confused with a good bounce.

**Trailing Edge**

RC Term

The rearmost edge of the wing or stabilizer.

**Trainer**

RC Term

A model designed to be inherently stable and fly at low speeds, to give first-time modelers time to think and react as they learn to fly.

**Training Aids**

RealFlight Term

RealFlight 9 offers a variety of features to learn new maneuvers. These consist of training aids that take you through step-by-step basic flight lessons, such as takeoffs and landings for airplanes, and Hovering practice for helicopters. Prerecorded lessons are also available from professional pilots.

**TruFlo Wind Dynamics**

RealFlight Term

RealFlight 9's TruFlo Wind Dynamics is the most accurate wind model ever released in an RC simulator. It combines five different wind models to recreate the ever-changing wind fields found at a real flying site.

**Turbulence System**

RealFlight Term

This is the ability of RealFlight to induce turbulent, rough air, as would be experienced at the flying site.



**USB**

Computer Term

USB, or Universal Serial Bus, is a connection protocol for computer peripheral devices (like Great Planes' USB InterLink-X Controller). USB technology allows you to connect multiple devices to your computer, and supports high data transfer rates and is hot swappable. USB devices have a special connector that only fits into a USB port. Most modern personal computers have USB ports, which are usually clearly labeled. Some computers have one or more USB ports on the front of the computer housing, although the USB ports are usually on the back of the computer.

**Variometer**

RC Term

An instrument designed to indicate the rate of climb or descent of an aircraft.

**Video Card**

Computer Term

A card inside your computer that produces the images on your video monitor. Most modern 3D video cards have accelerated 3D operations—that is, they perform numerical calculations for rendering a 3D scene, to free up your computer's CPU to perform other tasks. The video card plugs into your computer's motherboard. You can upgrade your video card (or the software driver that controls it) without replacing your computer.

**Viewport**

RealFlight Term

A picture-in-picture display set within the RealFlight 9 main display. The Viewport is independently adjustable and serves as its own unique "window on the world".

**Washout**

RC Term

An intentional twist in the wing, which causes the wing tips to have a lower angle of attack than the wing root. In other words, the trailing edge is higher than the leading edge at the wing tips. Washout helps to prevent tip stalls.

## **Waterfall**

RC Term

The Waterfall is a maneuver where the plane pivots 360 degrees in the pitch axis with as little forward motion and altitude deviation as possible. As the name suggests, this maneuver resembles a waterfall during flight.

## **Wing Loading**

RC Term

The amount of weight per square foot that has to be overcome to provide lift. It is normally expressed in ounces per square foot. This specification can be easily calculated as follows: first determine the area of the wing in square inches then, simply divide by 144 to obtain square feet. Divide the total weight (in ounces) of the airplane by the wing area (in square feet).

This information is valuable when deciding on which airplane to build next. Planes with high wing loading must fly faster to stay in the air. These are generally "performance" airplanes. Conversely, a plane with lower wing loading does not need as much air flowing around the wing to keep it flying. Gliders and trainer airplanes fall into this category because in this case, slow, efficient flight is highly desirable.

## **Yaw Axis**

RC Term

The airplane axis controlled by the rudder. Yaw is illustrated by hanging the airplane level by a wire located at the center of gravity. Left or right movement of the nose is the Yaw movement.

# Index

- About, 317**
- AccuModel, 8, 352**
- Advanced Flight Recorder, 9, 353**
- Aerobatics, 328**
- AFR.** *See* Advanced Flight Recorder
- Aircraft Editor, 38, 128**
  - Add Component, 141**
  - Aircraft Parts Tree, 138**
  - Delete Component, 141**
  - Parameter Window, 141**
  - Preview Screen, 140**
  - Show Wireframe, 137**
- Aircraft Menu, 124**
- Aircraft MRU, 30, 152**
- Aircraft Selection, 28, 125, 126**
  - Description, 126**
  - Specifications, 126**
- Aircraft Variant, 76**
- Airframe, 354**
- Airplane Basics, 326**
- Airplane Flight, 327**
- Airplane Hover Trainer, 283**
- Airplane Physics.** *See* Physics
- Airport, 221**
- Airport Editing, 37**
- Airport MRU, 32, 183**
- Airport Selection, 31, 154**
- Airspeed, 198**
- Altitude, 199, 210**
- Audio, 82**
- Auto-Play, 354**
- Autorotation, 354**
- Autozoom, 298**
- Battery, 211**
- Binocular, 201**
- Bloom, 100, 355**
- Boundary, 273, 285**
- Camera, 85**
- Camera Position, 296**
- Camera Type, 294**
- Capture Screenshot, 121**
- Channel Mapping, 355**
- Chase View, 295**
- Chat, 94, 253, 355**
- Child, 139, 160, 355**
- Clear Aircraft Position, 149**
- Clouds, 98**
- Cockpit View, 294**
- Collective, 330**
- Color Scheme, 75, 127**
- ColorSchemes, 146**
  - Alpha Channels, 147**
  - PowerReflectiveOff, 146**
  - PowerReflectiveOn, 146**
  - PowerSpecularOff, 146**
  - PowerSpecularOn, 146**
  - Reflectivity, 146**
  - Specular, 146**

**Commands, 96, 97**

**Console, 86**

**Controller Menu, 184**

**Crashing, 322, 326**

**Cyclic Stick, 332**

**Deadstick, 357**

**DirectX, 358**

**Disconnect, 227**

**Display Properties, 339**

**Drivers, 15, 346, 359**

**Edit Airport, 156**

**Effects, 292**

**End Game List, 232**

**Errors, 93**

**Export, 75, 79**

**Filter Servers, 223**

**Fixed Position, 294**

**FlexiField, 9, 37, 361**

**Flight Failures, 10, 63, 361**

**Float Fly, 7**

**Fly Camera, 161**

**Folder Listing Window, 166, 167**

**Foliage Density, 101**

**Forward Flight, 334**

**G Force, 210**

**G3X. *See* RealFlight Archive**

**Gadgets, 35, 259, 362**

**Gadgets Menu, 197**

**Game, 221**

**Game Gadgets, 242**

**Game Help, 241**

**Global Wind, 362**

**Graphics, 98, 199**

**Graphics Frame Rate, 212**

**Great Planes, 315**

**Ground Speed, 211**

**Grouping, 126, 155, 164, 362**

**Gyro, 334**

**Head Tracking, 302**

**Heading, 211**

**Height, 212**

**Heli Hover Trainer, 271**

**Heli Orientation Trainer, 282**

**Helicopter Basics, 329**

**Helicopter Physics. *See* Physics**

**Help Contents, 304, 305, 306, 307**

**Help Menu, 303, 318**

**Host, 224**

**Hovering, 334**

**Hovering Training Aids, 8**

**Idle-Up, 333**

**Import, 73**

**Installing RealFlight, 14**

**Instructions, 88**

**Interface Mode, 364**

**InterLink Elite, 364**

**IP Address, 364**

**Join, 220**

**Joystick Emulation, 365**

**Joystick Mode, 365**

**Keep Ground in View, 298**

**KEX, 73**

**Keyboard Commands, 40, 308**

**Kill Engine, 151**

**Knife Edge Software, 315**

**Knowledge Base, 345, 347**

**LAN, 215, 365**

**Landings, 328**

**Language, 106, 108**

**Latency, 221**

**Launcher, 10, 336**

**License, 310, 316**

**List Server, 366**

**Look At, 136, 297**

**Look From, 136**

**Manage Ban List, 227, 236**

**Manage Game List, 233**

**Manage User Files, 77**

**Manual View, 298**

**Max Players, 225**

**Message Boards, 346, 347**

**Metric Units, 114, 134, 165**

**Microphone, 248, 262**

**Movement Modes, 155**

**MRU, 367**

**MultiMode, 111, 254**

**Multiplayer, 9, 39, 110, 205, 215, 367**

**Multiplayer Menu, 215**

**Multiplayer Session, 224**

**Mute Audio, 80**

**NaturalPoint, 302**

**NavGuides, 9, 198, 210, 359, 367**

**Night Flying, 8, 100**

**Normal Camera, 162**

**Normal Maps, 101**

**Notifications, 91**

**Object Palette Window, 166, 170**

**Orientation, 275, 287**

**Overhead, 205**

**Overhead View, 8**

**Pan Camera, 161**

**Parent, 139, 160, 367**

**Particles, 99, 102**

**Password Protection, 226**

**Performance, 349**

**PhotoField, 8, 367**

**Physics, 25, 53, 59, 62, 113**

**Physics Frame Rate, 212**

**Pilot Nametags, 292**

**Pilot Preview, 166, 172**

**Pilot Profile, 238**

**Pilot Status, 242**

**Bullets, 243**

**Fuel, 242**

**Gun Temperature, 243**

**Health, 243**

**Paintball, 243**

**Poison, 243**

**Rockets, 243**

**Shield, 243**

**Speed Boost, 243**

**Pivot Camera, 161**

**Play Engine Sounds, 134**

**Playback Gadget, 259**

**Players, 221**

**Port numbers, 227**

**Power Ups**

**Bullets, 230**

**Fuel, 230**

**Infect, 230**

**Paintballs, 230**

**Points, 230**

**Poison, 231**

**Random, 231**

**Repair, 231**

**Rockets, 231**

**Shield, 231**

**Speed Boost, 231**

**Power-Ups, 229**

**Preview Screen, 155**

**Private, 368**

**Properties, 166**

**Properties Window, 169**

**Public, 368**

**Publish, 226**

**Quick Edit, 7, 143**

**Quick Load, 7, 208**

**QuickSelect, 7, 32, 33, 45, 46, 154, 198, 200, 202, 203, 369**

**Radio Gadget, 200**

**Radio Mode, 213**

**Raw Panoramic Image, 73**

**ReadySelect, 369**

**RealFlight Archive, 74**

**RealPhysics, 6, 369**

**Recordings, 257**

**Recordings Menu, 257**

**Recordings MRU, 263**

**Refresh, 222**

**Refresh Rate, 105**

**Reload Color Scheme, 135**

**Remember Aircraft Position, 148**

**Reset, 150**

**Reset to Defaults, 313**

**Resolution, 105**

**Restore Defaults, 337, 343**

**Rewind, 7, 115**

**RFX. *See* RealFlight Archive**

**Rotary Trails, 293**

**RotoSonics, 9**

**RPM, 199, 211**

**Rudder, 331**

**Safety Alerts, 117**

**Save Color Scheme, 145, 147**

**Scenery, 99, 291**

**Scoreboard, 237**

**Select Color Scheme, 144**

**Select Level, 283**

**Select Target, 246**

**Server Details, 240**

**Session Name, 221, 225**

**Settings, 81**

**Setup Failures, 68**

**Shadow, 99, 101**

**Show Title Bar, 122**

**Simulation Menu, 49, 153**

**Simulation Sounds, 247**

**Sky Grid, 8, 292**

**Software Radio, 372**

**Sound Card, 12**

**Speed, 210**

**Start Game, 228**

**Start Game List, 232**

**Stop Game, 232**

**Streamers, 10, 102**

**Sun, 174**

- Sun Azimuth, 175**
- Sun Inclination, 176**

**System Information, 338**

**System Requirements, 11**

**Takeoffs, 327**

**Targa (.tga) File Format, 145**

**Targeting, 244**

**Targeting Ring, 244**

**Technical Support, 338, 340, 342, 346, 347**

**Technical Support Menu, 314**

**Terrain Detail, 99**

**Texture, 102**

**Thermals, 177**

- Dynamic, 177**
- Simple, 177**

**Throttle Hold, 334**

**Timer, 206, 207**

**TrackIR, 302**

**Trails, 8, 293**

**Training Aids, 35, 264, 374**

**Training Menu, 264**

**Transmitter, 23**

**Trees, 100**

**TruFlo Wind Dynamics, 8, 374**

**U.S. Patent, 43**

**Uninstalling, 343**

**Updates, 347**

**USB, 5, 6, 375**

**Use a Game List, 226**

**Variable Pitch Prop, 7**

**Variometer, 204, 375**

**Vertical Sync, 106**

**Video Card, 12**

**Video Player, 311**

**View Menu, 290**

**Viewport, 9, 34, 202, 375**

**VirtualRevolution, 9**

**Voice Chat, 247**

**Voltage, 211**

**Warnings, 92**

**Water, 101**

**Websites, 315**

**Wind, 118, 119, 177, 199, 211**

- Wind Gust, 119**
- Wind Variation, 119**

**Wind Direction, 179**

**Wind Field Indicators, 100, 293**

**Wind Speed, 180**

**Zoom, 212**

- Zoom In, 162, 299**
- Zoom Out, 163, 300**
- Zoom Reset, 163, 301**
- Zoom Type, 298**





# License

REGISTERED VERSION: RealFlight® RC Simulator

## LIMITED USE SOFTWARE LICENSE AGREEMENT

This Limited Use Software License Agreement (the "Agreement") is a legal agreement between you, the end-user, and Knife Edge Software ("KES"). By continuing the installation of this game program, by loading or running the game, or by placing or copying the game program onto your computer hard drive, you are agreeing to be bound by the terms of this Agreement. If you do not agree to the terms of this Agreement, promptly return the game program and the accompanying items (including all written materials), along with your receipt to the place from where you obtained them for a full refund.

## KES SOFTWARE LICENSE

1. Grant of License. KES grants to you the limited right to use one (1) copy of the enclosed or foregoing game program (the "Software") on a single computer. You have no ownership or proprietary rights in or to the Software or the written materials accompanying the Software. For purposes of this section, "use" means loading the Software into RAM, as well as installation on a hard disk or other storage device. The Software shall be either returned to KES or destroyed when no longer used in accordance with this Agreement, or when the right to use the Software is terminated. You agree that the Software will not be shipped, transferred or exported into any country in violation of the U.S. Export Administration Act (or any other law governing such matters) and that you will not utilize, in any other manner, the Software in violation of any applicable law.

2. Commercial Use is Prohibited. Except as provided in paragraph 5. Herein below in regard to the Software, under no circumstances shall you, the end-user, be permitted, allowed or authorized to commercially exploit the Software, any data comprising the Software. Neither you nor anyone at your direction shall do any of the following acts (any such acts shall be deemed void and a breach of this Agreement) with regard to the Software, or any portion thereof, such as a screen display or a screenshot:

- a. Rent the Software;
- b. Sell the Software;
- c. Lease or lend the Software;

- d. Offer the Software on a pay-per-play basis;
- e. Distribute, by electronic means or otherwise, the Software for money or any other consideration; or
- f. In any other manner and through any medium whatsoever commercially exploit the Software or use the Software for any commercial purpose.

3. Additional Prohibited Uses. Neither you nor anyone at your direction shall take the following action in regard to the Software, or any portion thereof, such as a screen display or a screenshot:

- a. Modify, disassemble, reverse engineer or decompile Software;
- b. Translate the Software;
- c. Reproduce the Software;
- d. Publicly display the Software;
- e. Prepare derivative works based upon the Software except Permitted Derivative Works); or
- f. Distribute, by electronic means or otherwise, the Software.

4. Use of Other Material is Prohibited. Use, in any manner, of the trademarks, such as RealFlight RC Simulator (tm) logo, or symbols, art work, images, screen displays or screenshots, sound effects, music, and other such material contained within, generated by or relating to the Software is prohibited.

5. To Receive Permission to Commercially Exploit. If you desire to commercially exploit the Software, you may request a copy of and execute the Commercial Exploitation License Agreement for RealFlight RC Simulator (the "License") and forward the original License to KES Software at the address noted therein. Please note that KES may refuse your request and not sign the License in KES's sole discretion.

6. Restrictions Apply to Third Parties. The prohibitions and restrictions described herein apply to anyone in possession of the Software and/or Permitted Derivative Works.

7. Copyright. The Software and all copyrights related thereto (including all characters and other images generated by the Software or depicted in the Software) is owned by KES and is protected by United States copyright laws and international treaty provisions. You must treat the Software like any other copyrighted material. You may not otherwise reproduce, copy or disclose to others, in whole or in any part, the Software. You may not copy the written

materials accompanying the Software. The same restrictions and prohibitions regarding your use of the Software as provided in this Agreement apply to your use of the written materials accompanying the Software. The written materials are owned by KES and are protected by United States copyright laws and international treaties. You agree to use your best efforts to see that any user of the Software licensed hereunder complies with this Agreement.

8. **Limited Warranty.** KES warrants that if properly installed and operated on a computer for which it is designed, the Software will perform substantially in accordance with the accompanying written materials for a period of ninety (90) days from the date of purchase of the Software. KES's entire liability and your exclusive remedy shall be, at KES's option, either (a) return of the price paid or (b) repair or replacement of the Software that does not meet KES's Limited Warranty. To make a warranty claim, return the Software to Horizon Hobby, LLC, 2904 Research Road, Champaign, IL 61822 USA accompanied by proof of purchase, your name, your address, and a statement of defect. This Limited Warranty is void if failure of the Software has resulted in whole or in part from accident, abuse, misapplication or violation of this Agreement. Any replacement Software will be warranted for the remainder of the original warranty period or thirty (30) days from your receipt of the replacement software, whichever is longer. This warranty allocates risks of product failure between Licensee and KES. KES's product pricing reflects this allocation of risk and the limitations of liability contained in this warranty.

9. **NO OTHER WARRANTIES.** KES DISCLAIMS ALL OTHER WARRANTIES, BOTH EXPRESS IMPLIED, INCLUDING BUT NOT LIMITED TO, IMPLIED WARRANTIES OF MERCHANTABILITY OR FITNESS FOR A PARTICULAR PURPOSE WITH RESPECT TO THE SOFTWARE AND THE ACCOMPANYING WRITTEN MATERIALS. THIS LIMITED WARRANTY GIVES YOU SPECIFIC LEGAL RIGHTS. YOU MAY HAVE OTHER RIGHTS WHICH VARY FROM JURISDICTION TO JURISDICTION. KES DOES NOT WARRANT THAT THE OPERATION OF THE SOFTWARE WILL BE UNINTERRUPTED, ERROR FREE OR MEET LICENSEE'S SPECIFIC REQUIREMENTS. THE WARRANTY SET FORTH ABOVE IS IN LIEU OF ALL OTHER EXPRESS WARRANTIES WHETHER ORAL OR WRITTEN. THE AGENTS, EMPLOYEES, DISTRIBUTORS, AND DEALERS OF KES ARE NOT AUTHORIZED TO MAKE MODIFICATIONS TO THIS WARRANTY, OR ADDITIONAL WARRANTIES ON BEHALF OF KES. ADDITIONAL STATEMENTS SUCH AS DEALER ADVERTISING OR PRESENTATIONS, WHETHER ORAL OR WRITTEN, DO NOT CONSTITUTE WARRANTIES BY KES AND SHOULD NOT BE RELIED UPON.

10. **Exclusive Remedies.** You agree that your exclusive remedy against KES, its affiliates, contractors, suppliers, and agents for loss or damage caused by any defect or failure in the Software regardless of the form of action, whether in contract, tort, including negligence, strict liability or otherwise, shall be the return of the purchase price paid or replacement of the Software. This Agreement shall be construed in accordance with and governed by the laws of the State of Oregon. Copyright and other proprietary matters will be governed by

United States laws and international treaties. IN ANY CASE, KES SHALL NOT BE LIABLE FOR LOSS OF DATA, LOSS OF PROFITS, LOST SAVINGS, SPECIAL, INCIDENTAL, CONSEQUENTIAL, INDIRECT OR OTHER SIMILAR DAMAGES ARISING FROM BREACH OF WARRANTY, BREACH OF CONTRACT, NEGLIGENCE, OR OTHER LEGAL THEORY EVEN IF KES OR ITS AGENT HAS BEEN ADVISED OF THE POSSIBILITY OF SUCH DAMAGES, OR FOR ANY CLAIM BY ANY OTHER PARTY. Some jurisdictions do not allow the exclusion or limitation of incidental or consequential damages, so the above limitation or exclusion may not apply to you.

11. General Provisions. Neither this Agreement nor any part or portion hereof shall be assigned, sublicensed or otherwise transferred by you. Should any provision of this Agreement be held to be void, invalid, unenforceable or illegal by a court, the validity and enforceability of the other provisions shall not be affected thereby. If any provision is determined to be unenforceable, you agree to a modification of such provision to provide for enforcement of the provision's intent, to the extent permitted by applicable law. Failure of a party to enforce any provision of this Agreement shall not constitute or be construed as a waiver of such provision or of the right to enforce such provision. If you fail to comply with any terms of this Agreement, YOUR LICENSE IS AUTOMATICALLY TERMINATED.

YOU ACKNOWLEDGE THAT YOU HAVE READ THIS AGREEMENT, THAT YOU UNDERSTAND THIS AGREEMENT, AND UNDERSTAND THAT BY CONTINUING THE INSTALLATION OF THE SOFTWARE, BY LOADING OR RUNNING THE SOFTWARE, OR BY PLACING OR COPYING THE SOFTWARE ONTO YOUR COMPUTER HARD DRIVE, YOU AGREE TO BE BOUND BY THIS AGREEMENT'S TERMS AND CONDITIONS. YOU FURTHER AGREE THAT, EXCEPT FOR WRITTEN SEPARATE AGREEMENTS BETWEEN KES AND YOU, THIS AGREEMENT IS A COMPLETE AND EXCLUSIVE STATEMENT OF THE RIGHTS AND LIABILITIES OF THE PARTIES. THIS AGREEMENT SUPERSEDES ALL PRIOR ORAL AGREEMENTS, PROPOSALS OR UNDERSTANDINGS, AND ANY OTHER COMMUNICATIONS BETWEEN KES AND YOU RELATING TO THE SUBJECT MATTER OF THIS AGREEMENT.

# Credits

**Produced by** Horizon Hobby, LLC  
2904 Research Road  
Champaign, IL 61822 USA  
[www.horizonhobby.com](http://www.horizonhobby.com)

**Developed by** Knife Edge Software  
Corvallis, OR  
[www.knifeedge.com](http://www.knifeedge.com)

**Original Concept** Scott Kemp

**Art** Lance Bass  
Hays Clark  
Tony Elms  
Ted Graves  
Marshall Huffman  
Angela Kemp  
Dave Lauck  
Joel Lee  
Dana "Airworks" Loncto  
Aaron Moore  
Kevin Nagatani  
Mike Nagatani  
Paul Naton  
De'Shan Perry  
Lyaksandr Prella-Tworek  
Josh Trevisiol  
DJ Vegh

**Development**

Jeremy Babbar-Sebens  
Scott Booth  
Zach Brockway  
Jim Coleman  
Ryan Douglas  
Dusty Eveland-DeWan  
Mark Finch  
Gerald Gale  
Brad Kessler  
Chris Keys  
Ed Koffeman  
Aaron Moore  
Japhet Stevens  
Adam Taylor  
Joe Tribal  
Travis Vitek  
Ted Zuvich

**InterLink DX**

Horizon Hobby, LLC.  
Knife Edge Software  
Revolution Robotics

## Flight Testing

John Adams  
Matt Andren  
Ryan Archer  
Augusto Arevalo  
Todd Bennett  
Matthew Botos  
Brian Bremer  
Dustin Buescher  
Kevin "Dunkin" Burner  
Jason Danhaki  
Charles Dawson  
Greg Duitsman  
Mark Fadely  
Jeff Fassbinder  
Kelly Gerber  
John Glezellis  
James Haley  
David A. Hourston  
Dan Landis  
Ali Machinchy  
Larry Markey  
Sean McMurtry  
Jason Merkle  
Chris Mulcahy  
Paul Naton  
Pete Niotis  
Frank Noll, Jr.  
Jason Noll  
David Payne  
Adam Ranck  
Dino Spadaccini  
Kyle Stacy  
Sean Sullivan  
Jeff Swartz  
Bobby Watts  
Jon Zaretsky  
Malorie Zastrow

<b>Marketing</b>	Cody Adair Alex Albors Benjamin Crow Jason Merkle
<b>Product Artwork</b>	Messifa Ankou  Wally Armstrong Mike Bowers Corinne (Corrie) Carlson Jennifer Cheely Gary Hunt Rebecca Lynch Jeremy Motley
<b>Project Management</b>	Jim Bourke Dustin Buescher Chris Dickerson James Haley Mark Williams
<b>Production</b>	Sally Meyer Jane Thrasher Wanda White
<b>Technical Consultants</b>	Michael Giger



## Testing

Ashley Barnts  
Mike Blauvelt  
Haley Bourke  
Ray Bourke  
Brooks Clark  
Benjamin Cloud  
Matthew Cloud  
Montana Harkin  
Carman Hendricks  
Chris McVey  
Eric Olsen  
Alex Sanabrais  
Annette Schiedler  
Sean Sullivan  
Derek Voegel  
Aleks Weber  
T.J. Weber  
Eddie Wells  
Jim Wiggin  
Chris Willette  
Christian Williams  
David Wright

**Special Thanks**

Ben Ambrose  
Jill Brinkoetter  
Avery Buescher  
Emma Buescher  
Neal Cloud  
Don Coulter  
Don Ferguson  
Teresa Fredericks  
Ben Godwin  
Bounchanh Grant  
Chuck Gratner  
Erin Hassan  
Martin Hepperle  
Albert & Jeanette Hibpshman  
Daniel Kempfues  
Neal Kuechler  
Dan Mason  
David McCallister  
P.B. Mink  
Andrew Richardson  
Jürgen Schrader  
Rory Schweighart  
Lisa "Weesa" Stirnemann  
Christine Marie Williams  
Donald Williams  
Russ Williamson  
Stefan Vorkoetter

**A Big Thanks Also To** The families of those who put many late nights into the production of this product.

**And To Knife Edge  
Mascots** The All-Seeing Gnome  
LuLu the Hula Girl

**Fair Skies** Joseph (Joe) Ambrose

**Aircraft and Other  
Textures**

Avant - Carbon Xtreme  
F-86 - Michael Chan Su  
Huey - Steve Stuart-Doig and Larry Jolly ([www.ljamp.com](http://www.ljamp.com))  
Ion-X, Fury - Miniature Aircraft  
Innovator - Thunder Tiger  
Mini IFO - Wild RC  
Simple Flier - Alexandre Kolyvanov, Donald Miller

## Legal

Program © 1997-2019, Knife Edge Software, LLC  
Helicopter Paint Schemes © 1999-2019, Knife Edge Software  
Title Page, Box, DVD Art © 2019, Horizon Hobby, LLC

FMOD Sound System  
© Firelight Technologies Pty, Ltd., 1994-2019

RakNet  
©2003-2019, Jenkins Software, LLC. All Rights Reserved.

Airfoil data courtesy  
UIUC Airfoil Coordinates Database  
Prof Michael Selig, Department of Aero Engineering,  
University of Illinois at Urbana-Champaign,  
<http://www.ae.uiuc.edu/>  
included under the terms of the GNU GENERAL PUBLIC LICENSE  
An ASCII readable version of this data can be found in  
your RealFlight 9 installation directory.

Portions of this software utilize SpeedTree technology.  
©2019 Interactive Data Visualization, Inc. All rights reserved.

Electric power system database courtesy of  
Capable Computing Inc., creators of MotoCalc.

This software is based in part on the work of  
the Independent JPEG Group

This software contains Autodesk® FBX® code developed by  
Autodesk, Inc. Copyright 2014 Autodesk, Inc. All rights,  
reserved. Such code is provided "as is" and Autodesk, Inc.  
disclaims any and all warranties, whether express or implied,  
including without limitation the implied warranties of  
merchantability, fitness for a particular purpose or non-  
infringement of third party rights. In no event shall  
Autodesk, Inc. be liable for any direct, indirect, incidental,  
special, exemplary, or consequential damages (including, but  
not limited to, procurement of substitute goods or services;  
loss of use, data, or profits; or business interruption)  
however caused and on any theory of liability, whether in  
contract, strict liability, or tort (including negligence or  
otherwise) arising in any way out of such code.

Seawind is a licensed trademark of Seawind/S.N.A., Inc.  
Seawind logo is used with permission of Seawind/S.N.A., Inc.

Havoc name is a trademark of Elite Aerosports  
Name and logo are used with permission of Elite Aerosports

All trademarks and registered trademarks are the property  
of their respective owners.

